

LiGrip H300

Rotating Handheld SLAM LiDAR System

User Manual

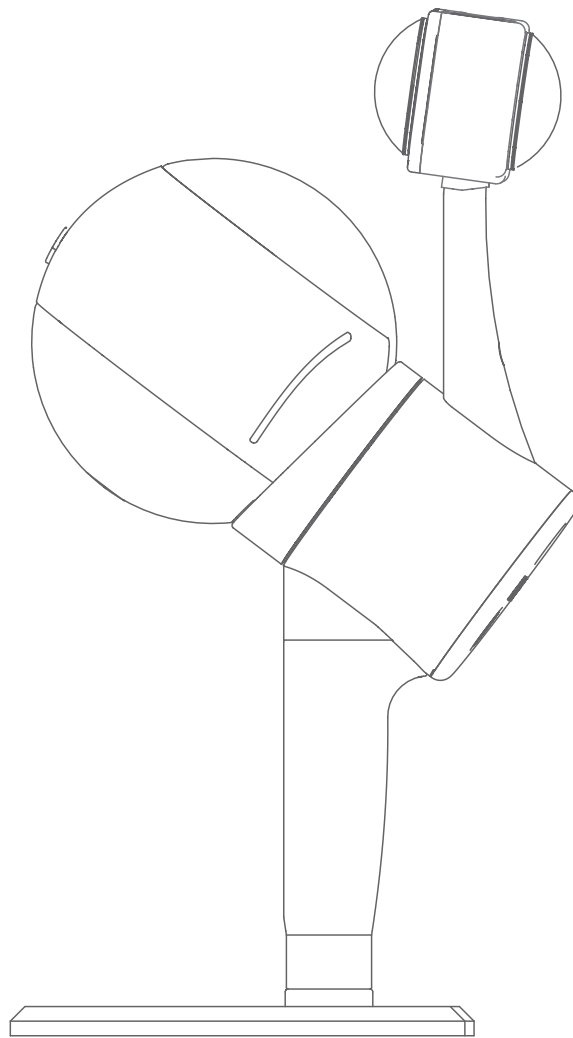

History Records

Date	Revisions	Description
April 26, 2023	1	LiGrip H300 User Manual (Ver A.00)
June 16, 2023	2	LiGrip H300 User Manual (Ver A.01)

Preface

Purpose

To allow users to be familiar with operations of the LiGrip H300, including assembly, data collection, solution, and multi-project merge.

Scope

The user manual applies to the LiGrip H300.

Warning Symbols



Note: Pay attention when operating.



Warning: The damage to the devices, data loss, data error, and system crash may occur if not following the relevant requirements.

Disclaimer

Users must read this manual carefully before operations. We shall not be liable for any damage caused by improper use of this product due to failure to operate in accordance with the instructions in this manual. We are committed to continually improving the functionality and performance of our products and services. We reserve the right to make changes to the contents of the user manual without prior notice.

This user manual is for reference only. The actual product, including but not limited to the picture color and size, may vary. All statements, information, and recommendations in this user manual do not constitute a warranty of any kind, expressed or implied.

The camera are well preset at factory. It is not allowed to change the settings. Otherwise, there may be no video files, color attachment disorder, or no color

attachment.

Your suggestions

If you have any suggestions or comments about this manual, please contact us, your feedback will greatly improve the quality of our manual.

Table of Contents

01 Overview of LiGrip H300	1
1.1 About LiGrip H300	2
1.2 Product Details	3
02 H300 Product Composition and Assembly	6
2.1 Product Composition	7
2.2 Device Assembly	9
2.2.1 H300 Assembly	9
2.2.2 Assembly of Backpack Kit	11
03 Path Planning, Zoning, and Control Point Planning	17
3.1 Closed Loop in Path Planning	18
3.2 Path Planning for Outdoor Scenarios	19
3.3 Path Planning for Indoor Scenarios	20
3.4 Path Planning for Strip Scenarios	21
3.5 Path Planning for Mine Caves	21
3.6 Path Planning for Forestry	21
3.7 Measurement in Special Areas (Tunnels and Mines)	22
3.8 Zoning	22
3.9 Control Point Planning	23
04 PPK mode and RTK mode Setup	25
4.1 Setting up PPK Base Stations	26
4.1.1 Base Station Assembly	26
4.1.2 Base Station Setup	26
4.1.3 Measuring Height of the Instrument	27

4.1.4 Static Recording	28
4.1.5 Data Transmission	29
4.2 RTK mode settings	29
4.3 Setting up a Virtual Base Station (Applicable in China)	32
05 Data Collection	34
5.1 Handheld Data Collection	35
5.1.1 APP-based Data Collection (recommended)	35
5.1.2 Button-based Operations	45
5.2 Data Collection of Backpack Kit	50
5.2.1 PPK Mode	50
5.2.2 RTK Mode	51
5.3 Things to Keep in Mind	62
5.3.1 For Data Collection in Outdoor Scenario	62
5.3.2 For Data Collection in Indoor Scenario	63
5.3.3 For Data Collection in Mine/Tunnel Scenarios	63
06 Data Copy	64
6.1 Introduction to the Project Files	65
6.2 Copying LiDAR Data via APP	66
6.3 Copying LiDAR Data by Using Network Cables	66
6.4 Copying Camera Files	67
6.5 Copying Base Station Files	69
6.5.1 Copying Base Station Files	69
6.5.2 Downloading Virtual Base Station Files (Applicable in China)	69
6.5.3 Downloading Base Station Files in RTK Mode	70
07 Data Processing	72
7.1 Data Preparation	73

7.2 LiFuser-BP New Project	74
7.2.1 Importing Original Data	74
7.2.2 GNSS Configuration (for backpack kits, vehicle-mounted kits, and airborne kits only)	75
7.2.3 Configuring Target Coordinate System	81
7.2.4 Configuring the Name and Project Path to Save Files	81
7.3 Running SLAM Program	82
7.4 GCP Adjustment	84
7.4.1 Data Preparation	84
7.4.2 SLAM processing -> GCP	84
7.4.3 Loading the GCP Coordinate File (geotag.txt)	85
7.4.4 Importing the Coordinates of Control Points	87
7.4.5 App GCP Transform	88
7.5 Data Quality Judgment	91
7.5.1 Viewing the Report	91
7.5.2 Checking Closed Loop	91
7.5.3 Loading Checkpoints	92
08 Multi-Project Merge	95
8.1 Creating a New Merge Project	96
8.2 Establishing Link Relation	97
8.2.1 Creating Link Relation with Absolute Coordinates	97
8.2.2 Creating Link Relation with Relative Coordinates	99
8.3 Point Cloud Stitching	102
8.4 Quality Assessment	104
8.5 Re-output	104
09 Maintenance and Upgrade	105

9.1 Firmware Upgrade	106
9.1.1 Online Upgrade	106
9.1.2 Offline Upgrade via USB Flash Drive	108
9.1.3 Camera Calibration Parameter Upgrade	109
9.2 Storage, Transport, and Maintenance	113
9.2.1 Storage	113
9.2.2 Transport	113
9.2.3 Maintenance	114
Appendix 1 Overview of SLAM	115
Appendix 2 SLAM Applicable Environment	116
Appendix 3 Troubleshooting-related Issues	118
1、 Initialization	118
2、 LiGrip Collection	118
3、 Vehicle-mounted Kit and Airborne Kit	119
4、 RTK Mode	119
Appendix 4 Product Specifications	121

CHAPTER

1

01 Overview of LiGrip H300

This section describes:

- About LiGrip H300
- Product Composition

1.1 About LiGrip H300

The LiGrip H300 is the latest generation of handheld laser 3D scanner launched by GreenValley International (GVI). The product features a minimalist style, compact body, lightweight handheld design, ease of use, and flexible installation. Equipped with a variety of sensors, it can quickly collect data in the range of scenario. The product supports multi-mode operations such as backpack, vehicle-mounted or airborne kits in multiple platforms. It supports multiple high precision mapping modes such as PPK-SLAM, RTK-SLAM and pure SLAM, to quickly acquire point cloud data with absolute coordinates. In conjunction with the LiDAR360 and LiDAR360MLS software of GreenValley International, the LiGrip H300 can be widely used in topographic mapping, forestry survey, indoor and outdoor integrated survey, earthwork survey, elevation mapping and other fields.

The LiGrip H300 handheld laser scanner can be combined with backpack, vehicle-mounted and airborne kits. With the newly developed RTK module, it can directly output ground point cloud data containing absolute coordinates, vehicle-mounted point cloud data and airborne point cloud data, to meet customers' operational needs in a variety of scenarios.



Figure 1-1 LiGrip H300 main unit



Figure 1-2 Handheld battery compartment



Figure 1-3 LiGrip H300 and backpack kit (see kit documentation for vehicle-mounted and air-mounted kits)

1.2 Product Details

The LiGrip H300 consists of main unit, battery compartment, B58 battery, camera, and related accessories.



Figure 1-4 LiGrip H300 components



Black button: On/off
Red button: End recording

Figure 1-5 One-inch camera

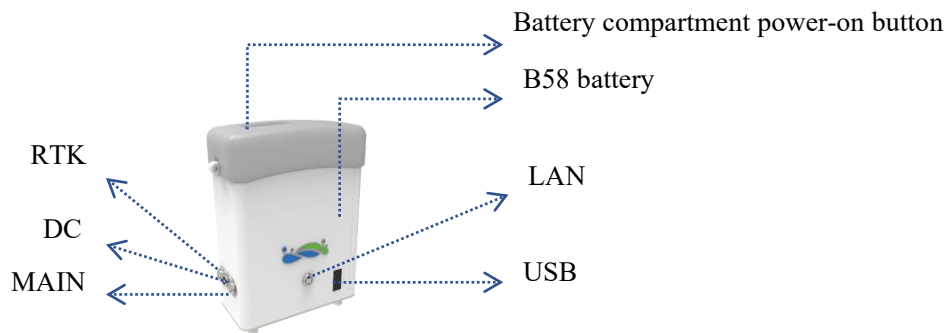

Figure 1-6 Battery compartment

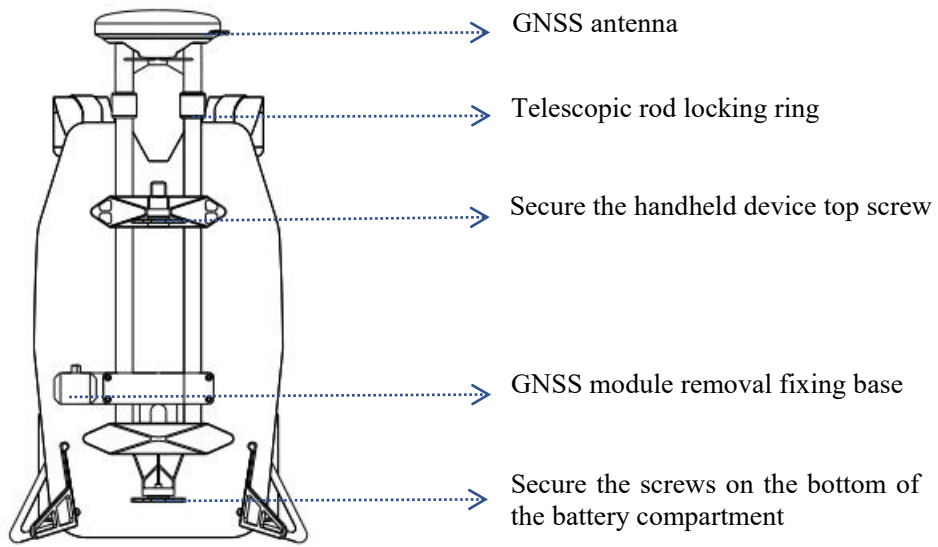

Figure 1-7 Backpack kit (retracted state)

CHAPTER

2

02 H300 Product Composition and Assembly

- Product Composition
- Product Assembly

2.1 Product Composition



Figure 2-1 Product composition

1. Handheld device main unit *1

For LiDAR, IMU, and video files data.

2. Handheld device battery compartment*1

For storing LiDAR, IMU, GNSS data and sending control commands.

3. Back strap*1

For carrying the battery compartment.

4. Main unit power cable*1

For powering the main unit and transmitting data during collection.

5. Data transmission cable*1

For copying the raw radar, IMU, and GNSS data collected.

6. B58 battery*1

For powering the entire unit.

7. Laser scanner protective cover*1

For protecting the LiDAR device.

8. Battery charger*1

For charging the B58 batteries.

9. USB flash drive*1

For the data transfer in case of copying.

10. Transport case*1

For storing and transporting equipment.

11. Backpack kit (optional)

Backpack kit with its own GNSS device.

12. RTK module (optional)

Support real-time RTK-SLAM scanning.

2.2 Device Assembly

2.2.1 H300 Assembly



Figure 2-2 Inserting the B58 battery



 The power button faces in the direction of the power hole.



Figure 2-3 Connecting the handheld main unit to the battery compartment (MAIN port) by using the power cable

 One end of the power cable connects to the handheld device and the other end

connects to the battery compartment MAIN port. In the insertion, **the red dot faces upwards!** Make sure that the insertion is successful.



Figure 2-4 Connecting the back strap and removing the protective cover



When removing the protective cover, take care to hold the main unit device steadily.



Figure 2-5 Assembly completed

2.2.2 Assembly of Backpack Kit

(1) Composition of the backpack kit

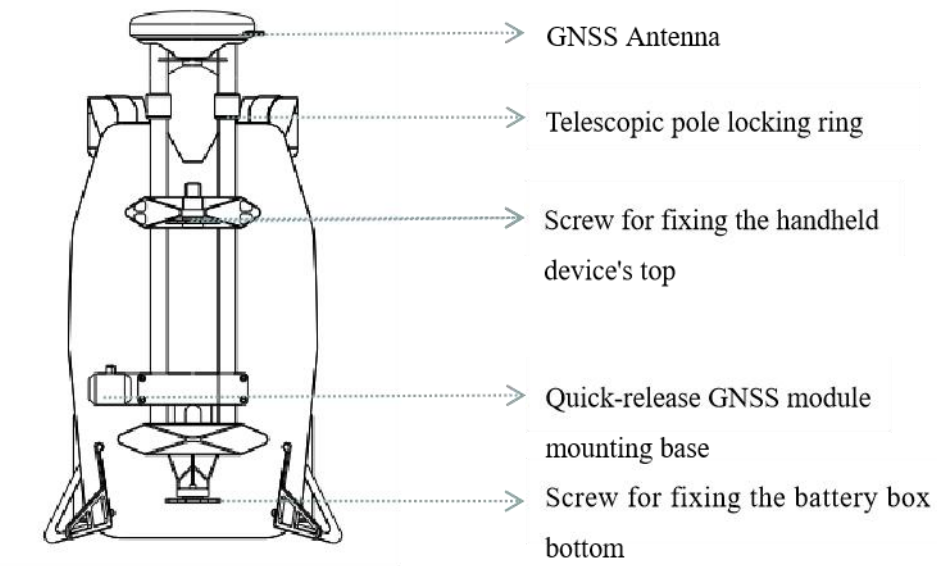

Figure 2-6 Composition of the backpack kit

(2) Assembly of the backpack kit



Figure 2-7 Aligning the battery compartment with the bottom screws and securing it



Figure 2-8 Disassembling the base



Figure 2-9 Comparison of backpack kit (before and after withdrawal)

 **The telescopic rod must be fully withdrawn. Otherwise, the measurement is inaccurate.**



Figure 2-10 Using the hand to hold the bottom to align with the top and insert it and tightening with screws

Place the GNSS bottom plug on the base of the backpack kit, to slide to the right side for locking. You will hear the clicking, indicating that it is locked successfully. If you need to remove it, you can press on the raised pin and slide to the left.



Figure 2-11 Fixing the GNSS module on the kit base



Figure 2-12 Inserting GNSS feeder cable into the GNSS interface of the GNSS module



Figure 2-13 Inserting the RTK cable into the RTK interface of the main unit box and GNSS module respectively



Figure 2-14 GNSS module connection status



Figure 2-15 Connecting the power cable (MAIN port)



When installing the backpack kit, two persons are required, to ensure no physical injury or damage to the device.

The backpack kit is assembled completely.



Figure 2-16 Assembly effect of backpack kit

CHAPTER

3

03 Path Planning, Zoning, and Control

Point Planning

- Path planning for outdoor scenarios
- Path planning for indoor scenarios
- Path planning for strip scenarios
- Path planning for mine caves
- Path planning for forestry
- Zoning
- Control point planning

The key to successful collection is excellent path planning, zoning and control point planning.

3.1 Closed Loop in Path Planning

The closed-loop can better improve the reliability and accuracy of data. Therefore, when conditions permit, data should be collected in a closed-loop route as much as possible.

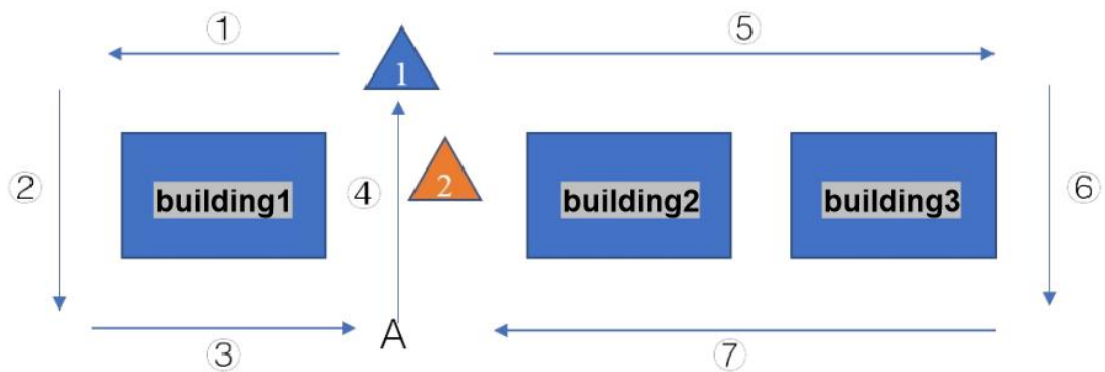

Figure 3-1 Closed-loop path

As shown in Figure 3-1, buildings 1, 2 and 3 are the objects to be scanned. It is recommended to start scanning from 1 rather than 2. Before you start scanning, plan your scanning route. According to the above rules, the route you can take to scan in this scenario is ①②③④⑤⑥⑦ or ⑤⑥⑦④①②③.

In the closed loop, you need to walk an extra 5-10 m distance to ensure that the closed loop is correct (as shown in Figure 3-2).

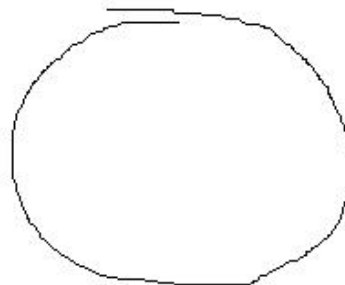

Figure 3-2 Correct closed loop (with certain overlapping between the start area and end area)

The following are examples of incorrect closed loops:

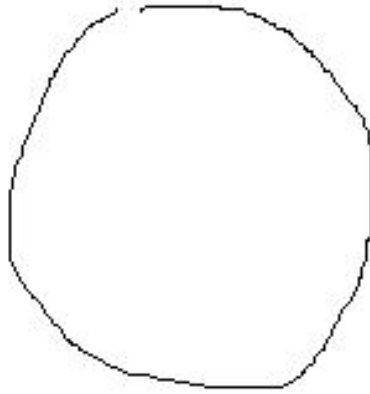

Figure 3-3 Insufficient closed loop distance

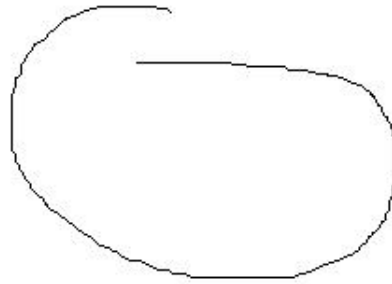

Figure 3-4 Incorrect closed loop area

3.2 Path Planning for Outdoor Scenarios

The close-loop is an effective way to improve SLAM accuracy. The closed loop is an effective way to improve the accuracy of SLAM. Therefore, when conditions permit, take a closed loop as much as possible to reduce control points and improve accuracy.

The ability to close the loop at the beginning and at the end can also improve the accuracy of the point cloud.

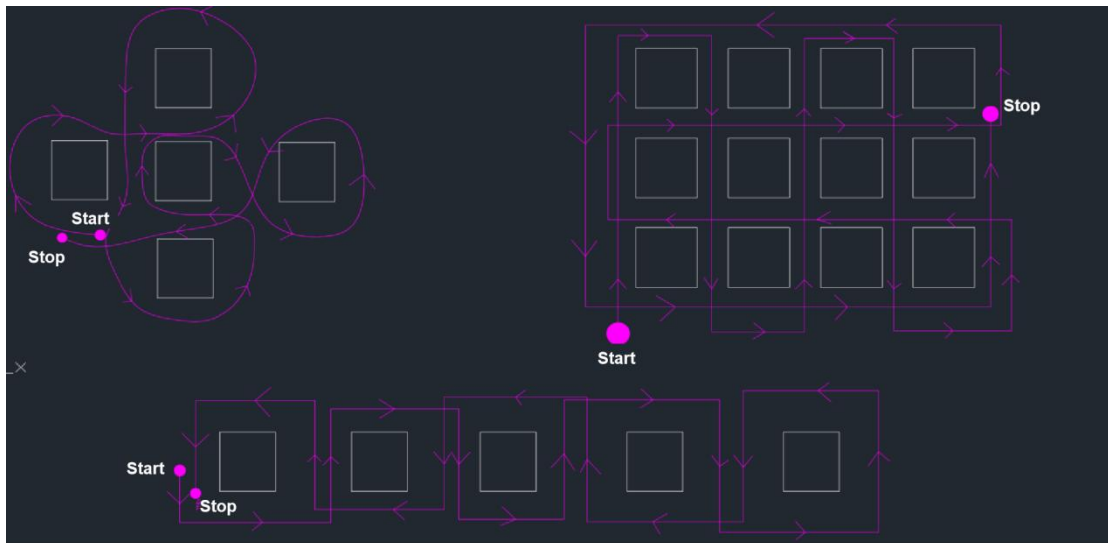

Figure 3-5 Path planning for outdoor scenarios

3.3 Path Planning for Indoor Scenarios

When conditions permit, take a closed loop for indoor scenarios as much as possible.

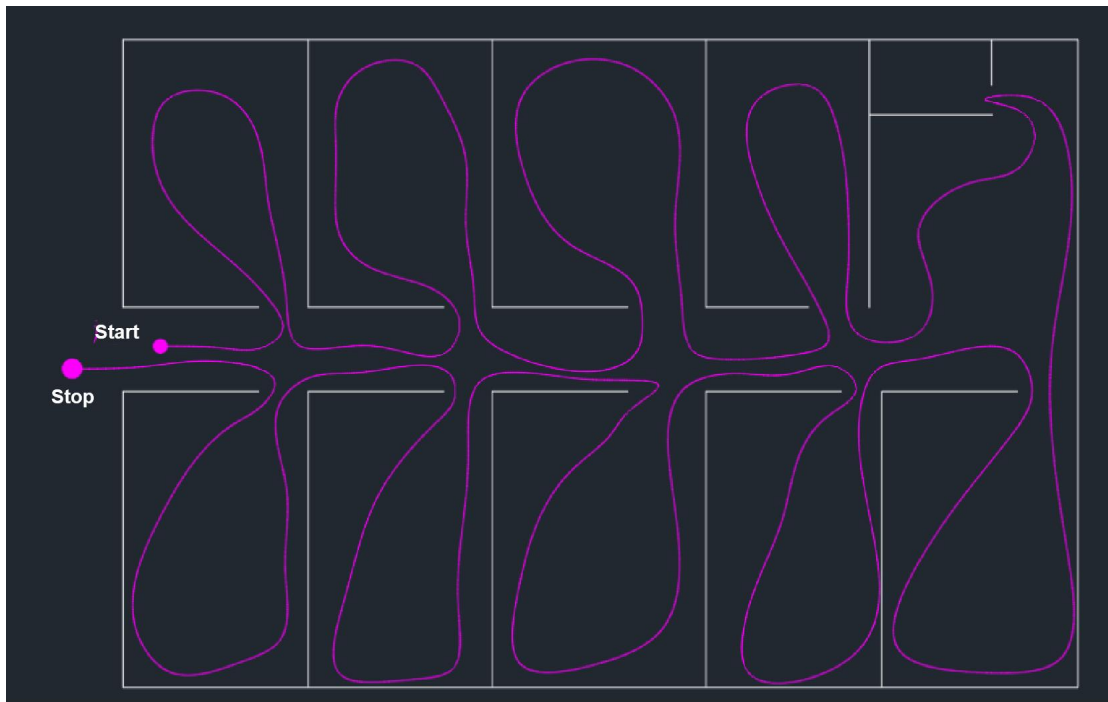

Figure 3-6 Path planning for indoor scenarios

Multi-floor data Collection: If you want to collect multi-floor data (for example, there are a total of 5 floors), you can measure floors 1-3 and then floors 3-5. As a result, there is at least one floor of overlapping area.

3.4 Path Planning for Strip Scenarios

When collecting data in scenarios such as roads, tunnels, mines, and electricity, it is not recommended to backtrack (unless it is necessary).

When collecting data at wider roads, it is recommended to collect data once at one side. This can reduce part of the cumulative error by taking an S-shape walk. If the high accuracy is required, it is recommended to arrange a control point at every 50 m.



Figure 3-7 Path planning for strip scenarios



If the traffic and pedestrian flow are dense, it is recommended to collect data at night (for example, 0:00 AM - 6 AM).



Note: Collect data in strip scenarios carefully. Do not set the control points in a straight line. Measure the control points on the left and right side in the strip scenario.

3.5 Path Planning for Mine Caves

When conditions permit, take a closed loop for mine caves as much as possible. If it is not possible to take a closed loop, control points need to be laid out and the measurement time should be kept within 30 minutes (if there is no light or dim light in the mine and the camera is not very useful, we recommend turning it off to extend the single operation time).

3.6 Path Planning for Forestry

Take a 30 m*30 m forestry sample area as an example:

The path planning is carried out for the collection sample area. The purpose of path planning is to collect all information about the trees with reducing data redundancy. For a 30 m*30 m sample area, if the trees are dense, use the path planning as shown

on the left; if the trees are sparse, use the path planning shown on the right:

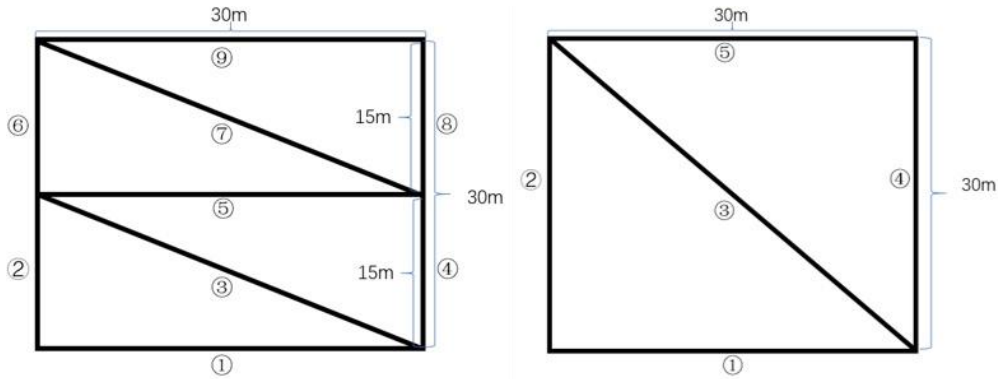

Figure 3-8 Path planning (dense trees: left sparse trees: right)

3.7 Measurement in Special Areas (Tunnels and Mines)

Where conditions permit, it is recommended that distinctive target objects, such as boxes, chairs, and tables should be set every 20 m - 30 m within the measurement area (objects should be large in size, with features distributed both horizontally and vertically).

It is recommended to scan in sections, with one section of 200 m - 300 m.



Figure 3-9 Additional feature points for scanning areas such as tunnels/mines

3.8 Zoning

If the survey area cannot be measured at one time, the area needs to be divided. The division principles are as follows:

- (1) Keep the measurement time for each area to a specified time.

- (2) Maintain an overlap of 10%-20% in each area.
- (3) The number of features within the overlapping area is sufficient.
- (4) If absolute coordinates are required, it is recommended that three or more control points should be arranged within the overlapping area.

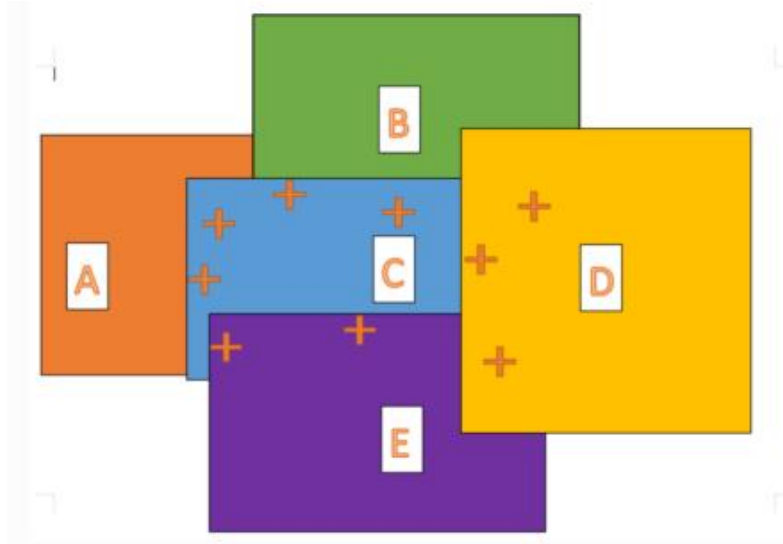

Figure 3-10 Zoning

3.9 Control Point Planning

In areas with good GNSS signals, the H120 backpack kit does not need control points. However, for some scenarios such as areas with poor GNSS signals (between high buildings, alleys), and areas without GNSS signals (underground corridors, underground car parks), a certain number of control points should be deployed to ensure the accuracy of the point cloud.

The control points need to be evenly distributed, with the circles in the figure below representing check points (the check points are used to verify the accuracy of the point cloud at a later stage) and the triangles representing control points that cover the entire survey area evenly.

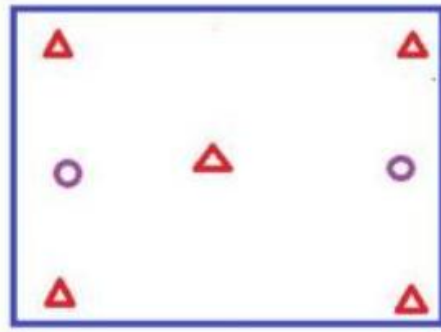

Figure 3-11 Control points evenly distributed in the survey area

 **DO NOT set up control points in a straight line.**

The correspondence between density and accuracy of control points is as follows:

The accuracy in Table 1 is for reference only. Here it highlights the differences in accuracy due to different control point densities as well as closed loops.

Table 1 Control point density and accuracy

Layout method \ RMSE	XY _{RMSE} /cm	Z _{RMSE} /cm
Straight line, every control point at a distance of 50 m	6.15	6.19
Straight line, every control point at a distance of 100m	6.99	12.29
Closed loop, every control point at a distance of 50 m	3.98	6.06
Closed loop, every control point at a distance of 100m	5.15	10.65

CHAPTER

4

04 PPK mode and RTK mode Setup

Backpack/Vehicle/Airborne kits require a base station or RTK mode service. This can be ignored if you are only using a handheld unit without a kit.

■ PPK base station assembly

Base station assembly

Base station setup

Measuring height of the instrument

Static recording

Data transfer

■ Setting up of Virtual Base Stations (if this service is available)

APP operation methods

■ RTK mode settings (if this service is available)

APP operation methods

The base station can be any brand of GNSS device.

4.1 Setting up PPK Base Stations

Physical base stations can any brand of GNSS devices, including, but not limited to LiBase.

4.1.1 Base Station Assembly

For more information about the use of the base station, see the manual for the base station.

4.1.2 Base Station Setup

The base station needs to be installed on a known point. The requirements are as follows:

- ① The ground base should be stable and solid, easy to set up and operate the base station.
- ② There should be open field of view. The height angle of obstacles around the field of view should be less than 10° - 15° , to ensure that the receive of satellite signals is not affected.
- ③ There should be no objects nearby that strongly reflect satellite signals (for example, large buildings).
- ④ The installation site should be far away from high-power radio emission sources (such as TV stations, radio stations, and microwave stations), and the distance should not be less than 200 m. The setup site should be far away from high-voltage transmission lines and microwave radio signal transmission channels, and the distance should not be less than 50 m.



Figure 4-1 Base station setup



The base station must be set up on the leveled ground. Otherwise, the data quality is not reliable.

4.1.3 Measuring Height of the Instrument

Instrument height = setup height of base station from the center on the ground to the measurement mark. For example, the mark position measurement highlighted in red in Figure 4-3.



Figure 4-2 Instrument height measurement



Figure 4-3 Instrument height measurement position

Measure the height of the instrument with a steel tape from 2 directions. If the error is less than 3 mm, take the average value to calculate the antenna height.

4.1.4 Static Recording

The static collection starts 10-15 minutes earlier than the LIDAR data collection.

The static collection ends approximately 10 minutes later than the end of the laser data collection.



Note: The base station should be set up to start the data recording at least 10 minutes earlier than the data collection of the handheld device. The data recording ends and the base station is off at least 10 minutes later than the end of the handheld collection. That is, the base station is still available even if the handheld collection ends.

4.1.5 Data Transmission

Copy the base station data files. If necessary, convert the static format of the GNSS receivers to the common Rinex format (O-file and P-file). By default, Libase has set the static data format to Rinex. Therefore, you can use it directly.

You can enter the coordinates of your own base station into the app interface, so that the coordinates can be easily recorded in the project task. You can later generate the base station coordinates inside the project catalog file. Enter data in the lifuser-bp or import it directly.

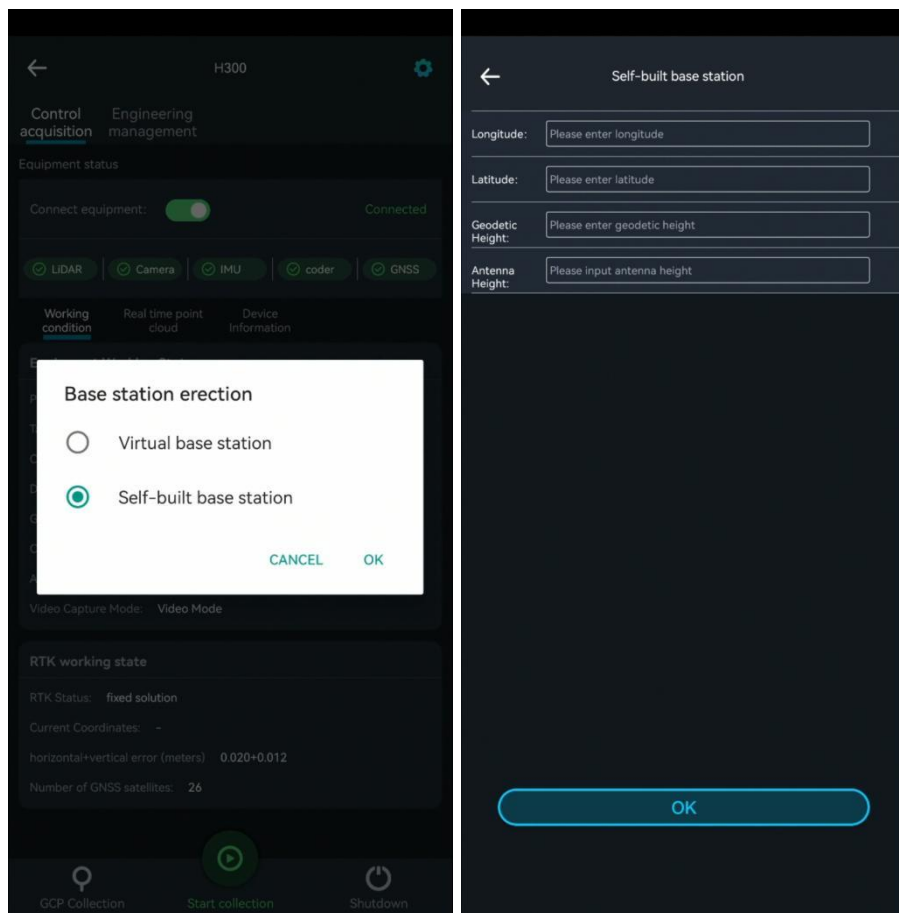

Figure 4-4 Set ppk base station in app

4.2 RTK mode settings

The GNSS module supports both PPK mode and RTK mode.

The RTK mode requires a CORS account before you can log in to the CORS network to obtain real-time differential data. If you do not have an available CORS account, the RTK mode of the GNSS module will not be available. The GNSS module only

supports the RTK mode in CORS mode.

Before using the RTK mode, make sure that your environment is in an open and well-searched area. For indoor and very poorly-searched areas, the RTK function is unavailable.

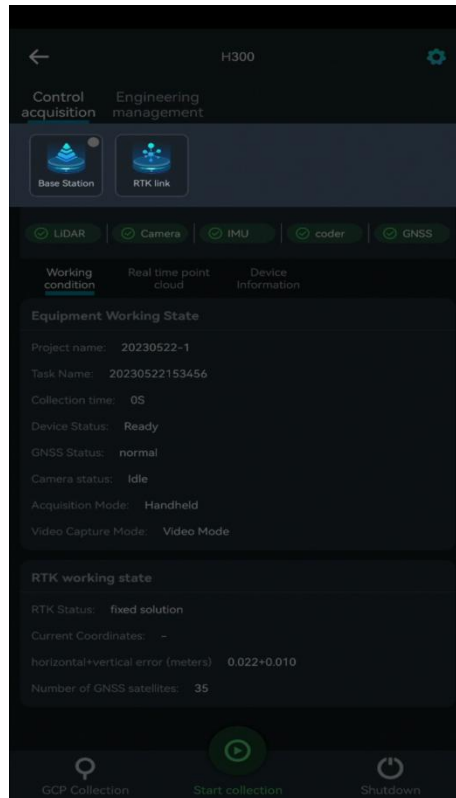

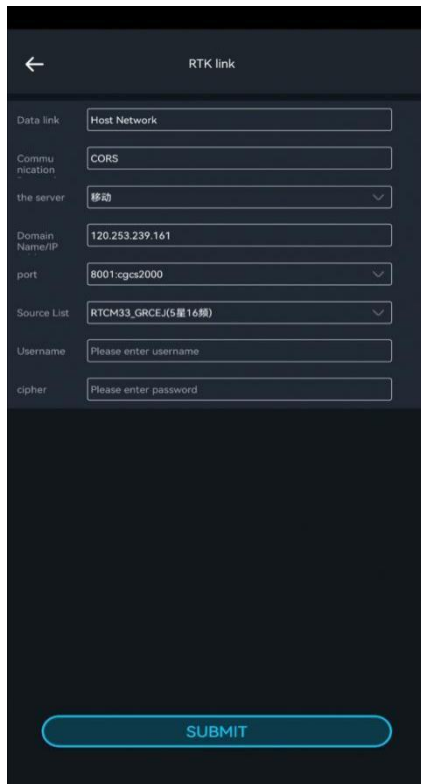

Tap Setting ——RTK link, to invoke the RTK function:

1. Choose CORS for the communication protocol
2. Server: select as required or enter the domain name
3. Port: Configure according to the port name and coordinate system given by your service provider
4. Source list: Select or enter the source list
5. User name/password: Enter the account and password obtained from the service provider
6. Submit (if your account and password are correct, the login is successful. You can obtain the differential data)

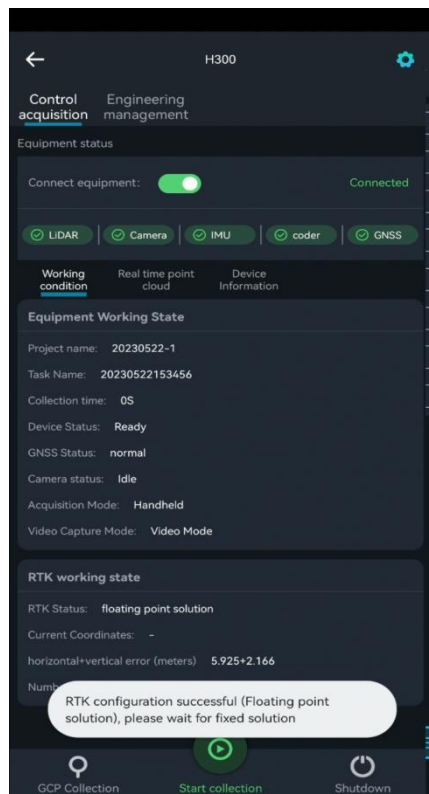

Wait for about 30 seconds. When there is differential data accessed, the working status bar will indicate a fixed solution;

If the system prompts the login failure or the solution is not fixed for a long time, check your account settings and star search environment.

After the RTK link is configured, the RTK status bar displays the real-time status information of the RTK module. The current RTK states include fixed solution, floating solution and single point solution.

	RTK Status	Explanation
①	Fixed solution	Indicates that the real-time RTK module has high positioning accuracy and the device meets the RTK data collection requirements.
②	Floating solution	Indicates that the satellite signal received by the RTK module at the current location is not good and there may be an obstruction nearby. Wait for the device to be fixed, or move the device to an open, unobstructed area with a good satellite signal and wait for the device to be fixed.
③	Single solution	Indicates that the RTK module at the current location is unable to receive satellite signals, or the satellite signal is poor. It is recommended to configure the RTK module in an open and unobstructed area.

After the data collection is finished, tap the Stop Collection button, the RTK module will stop working at the same time. The project will automatically store a .rtk file, which can be imported into LiFuser-BP for RTK solution. For details, refer to the operation of importing .rtk data to LiFuser-BP.

4.3 Setting up a Virtual Base Station (Applicable in China)

The virtual base station service is applicable in China by GreenValley, that is, pre-event base station. Set up the base station before the operation (setup on the APP), and stop data recording after the scanning.

Tap Settings --> Base station erection --> Virtual base station --> OK.

You will be prompted to enter the task name (confirm the coordinate system), and finally create it successfully.

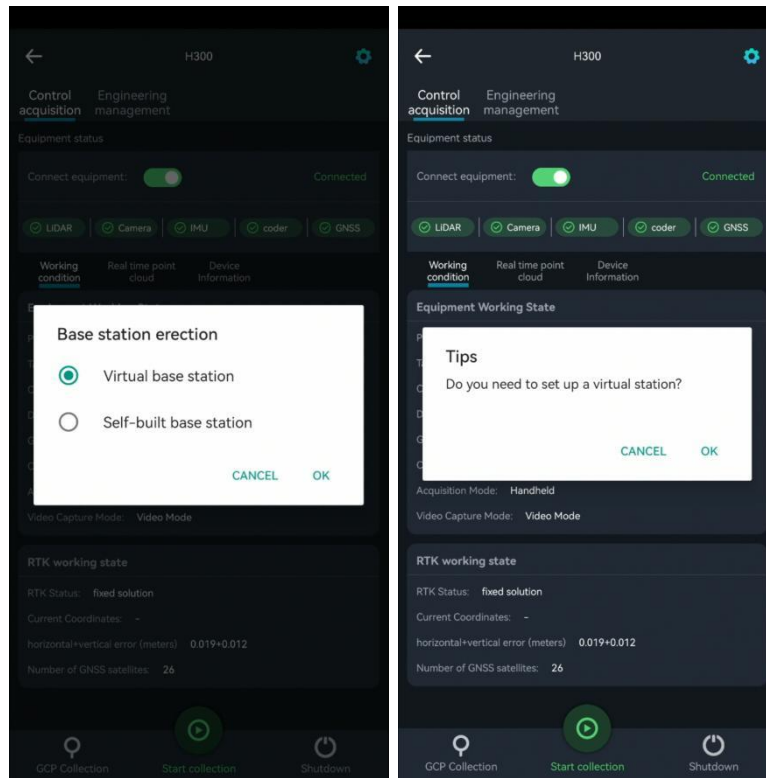

Figure 4-5 Set Virtual Base Station in app

After scanning, tap **Settings** --> **Base station erection** --> **Stop virtual base station** --> **OK**.

After stopping, the app will generate a base station record on the LiCloud backend.

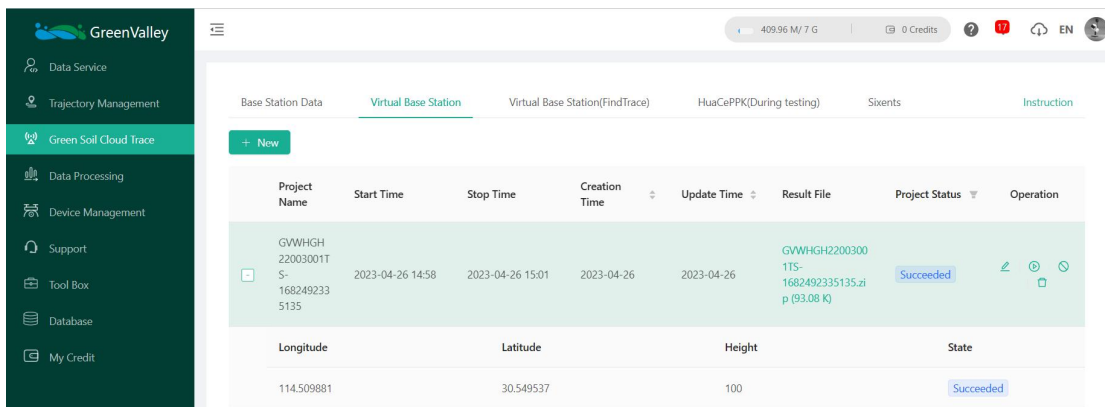

Figure 4-6 Virtual base station data download

The status “Succeed” is displayed, indicating that the data was created successfully. Data can be downloaded from the web page and imported into the LiFuser-BP for use.

CHAPTER

5

05 Data Collection

- Handheld data collection
- Backpack data collection
- Things to keep in mind

5.1 Handheld Data Collection

5.1.1 APP-based Data Collection (recommended)

(1) Advantages of APP data collection

① Voice broadcast

Clearly learn about the status of the current device. Solve the problem of not being able to see the flashing when collecting the GCP.

② Custom project name and sub project name

Customize the project name. As a result, you can easily know the data specifically by the project name.

③ Live site recording

You can clearly know the condition of the survey area by taking photos. It is convenient for the internal staff to understand the actual situation and adjust the slam parameters.

④ Real-time point cloud

You can view the current scanned data, range, and track of the measured area.

⑤ Data copy via USB flash drive

The data can be copied on site via USB port. Especially for desktop computers, it is not convenient to insert or remove via LAN port.

⑥ Delete project data via mobile App

Previously, data is deleted via connection to the computer if the data is full. Now, the problem is solved, that is, data can be deleted on site through App if the data is full.

(2) APP requirements for mobile phones/tablets

Currently only Android-based App is supported. The system requirements are as follows:

Version: Android V7.0 or later

Memory: RAM greater than 4GB

Storage: greater than 1GB

(3) WIFI password

greenvalley

5.1.1.1 Registration, Login and Device Binding

See the GreenValley APP User Manual

5.1.1.2 Initialization and Start of collection

To start collection, select an open initialization area with distinctive features. Keep the level bubble centered as far as possible, and make it stationary and steady by hand.

Requirements:

- (1) Choose a steady and solid ground surface or platform.
- (2) If GNSS signals are accessed, ensure good conditions for searching satellites (usually greater than 20).
- (3) Avoid strong electromagnetic interference in the vicinity.
- (4) Do not initialize in areas with heavy pedestrian or vehicular traffic.
- (5) Do not initialize in open areas.

(1) Keep the device on a stationary ground surface or platform

When the device is stationary on the ground or on a platform, try to keep the level bubble centered.



Figure 5-1 Placing on the ground or platform

 The battery compartment of the device should be placed as close as possible to the main unit of the handheld device. Otherwise, the camera will not start recording automatically

(2) Device power-up

Short-press the battery for 1s and then press for 2s to power it up.



Figure 5-2 Device power-up

(3) Camera power-on



Short-press the black button to turn on the camera. The camera screen lights up and the camera indicator turns light blue.



Figure 5-3 Camera power-on

(4) Device power-on

After the device power-on, the main unit button flashes rapidly. In this period, the camera will take a selfie (there will be a clicking sound) and the indicator light will turn on. The whole process takes about 30S.



Figure 5-4 Rapid flashing to always-on

(5) Start collection

After the device is assembled and powered on, connect the APP to the WiFi. Wait for the laser, camera, Inertial Navigation System (INS), and encoder to turn green √ (red × means the module is abnormal. In this case, check whether the device is turned on normally. At this time, the satellite is displayed as red ×, indicating that there is no satellite signal access. If the backpack kit is adapted to collect data, the satellite status is displayed as green √). Then, you can tap Start collection.

Tap the "Start collection" key in the GreenValley App to enter the "New Project" page. The GreenValley APP supports the creation of multiple sub-tasks under one project. Set the project name, collection location, notes, and coordinate system. The coordinate system can be selected according to the actual geographic location. Tap OK. The new project settings are completed. Select the appropriate project file, and fill in the actual work area information in the start collection interface. The sub-task project is created completely. The device starts to enter the initialization state. Wait for the APP device status to change to "Collecting". The APP prompts "device is collecting" via voice. Then, start data collection according to the planned route.

Note: The camera can be switched on by pressing the black button. If it is unnecessary to collect camera video, the power-on is not required. At this time, the camera status is displayed as red ×. After the collection starts, the camera will automatically start

recording, and the camera will **automatically** end when the collection is finished.



The video collection mode supports video recording mode and time-lapse photography mode. It is recommended that the collection time for video recording mode does not exceed 30 minutes, and the collection time for time-lapse photography mode does not exceed 60 minutes.

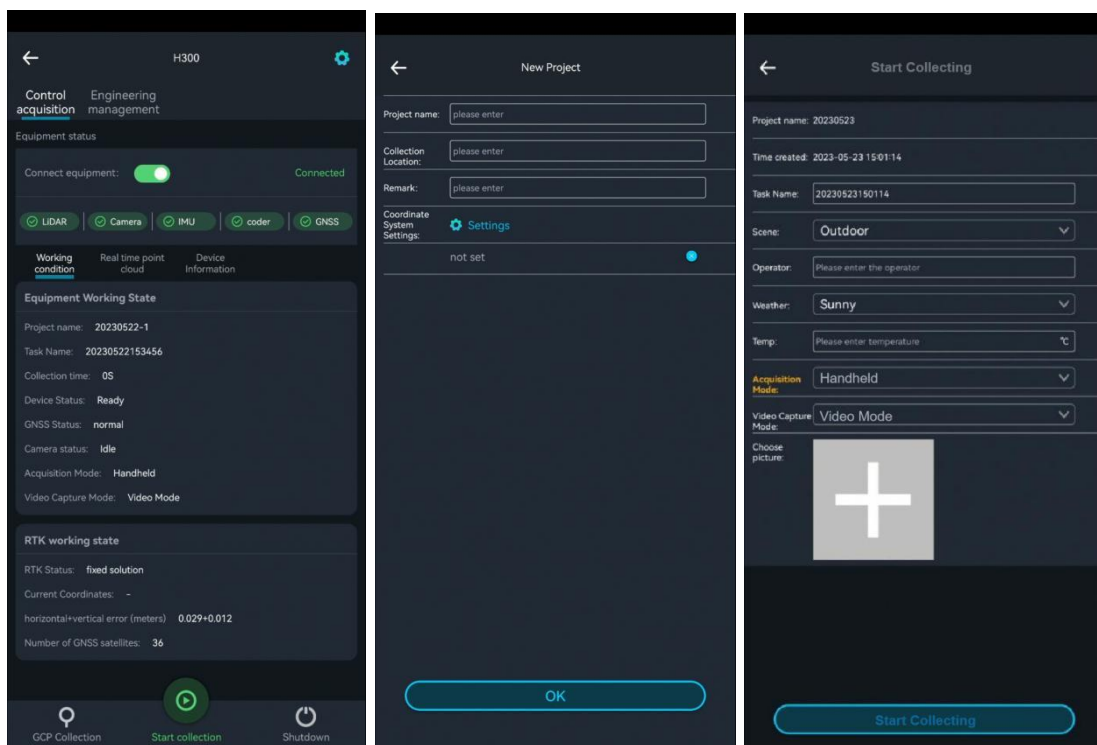

Figure 5-5 New project

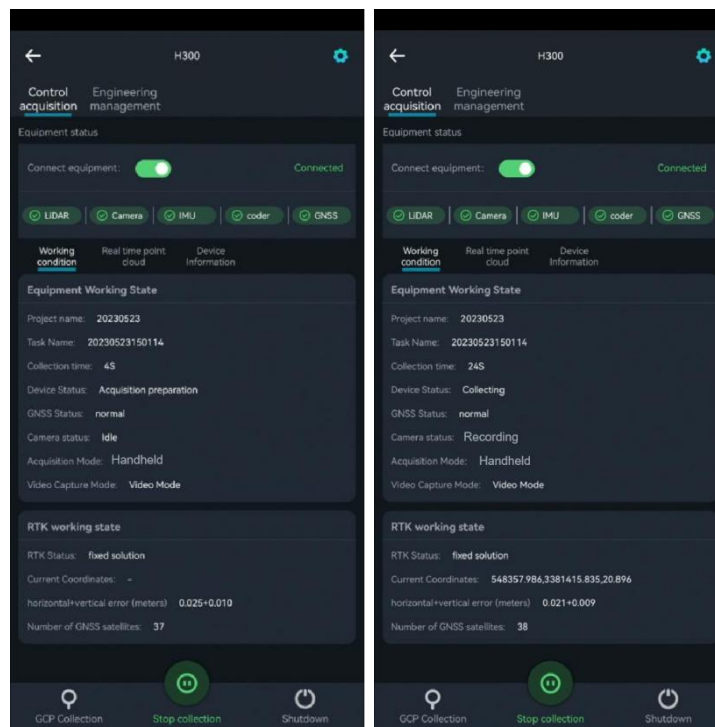

Figure 5-6 Device in the process of collection

5.1.1.3 Data Collection

Data collection is carried out according to the route planned in advance. For details, see [03 Path Planning, Zoning, and Control Point Planning](#).

Note: If video recording mode is used, it is recommended that the collection time is controlled within 30 minutes; if time-lapse photography mode is used, it is recommended that the time is controlled within 60 minutes.

5.1.1.4 Collecting Control Points (GCP collection)

- ① Align the "cross" hole of the GCP base with the control point and place the device firmly;



Figure 5-7 GCP collection (Align the "cross" hole with the control point)

② Tap "GCP collection" in the APP and wait a few seconds. When the indicator changes from a slow flashing to a fast flashing, collect the GCP once.

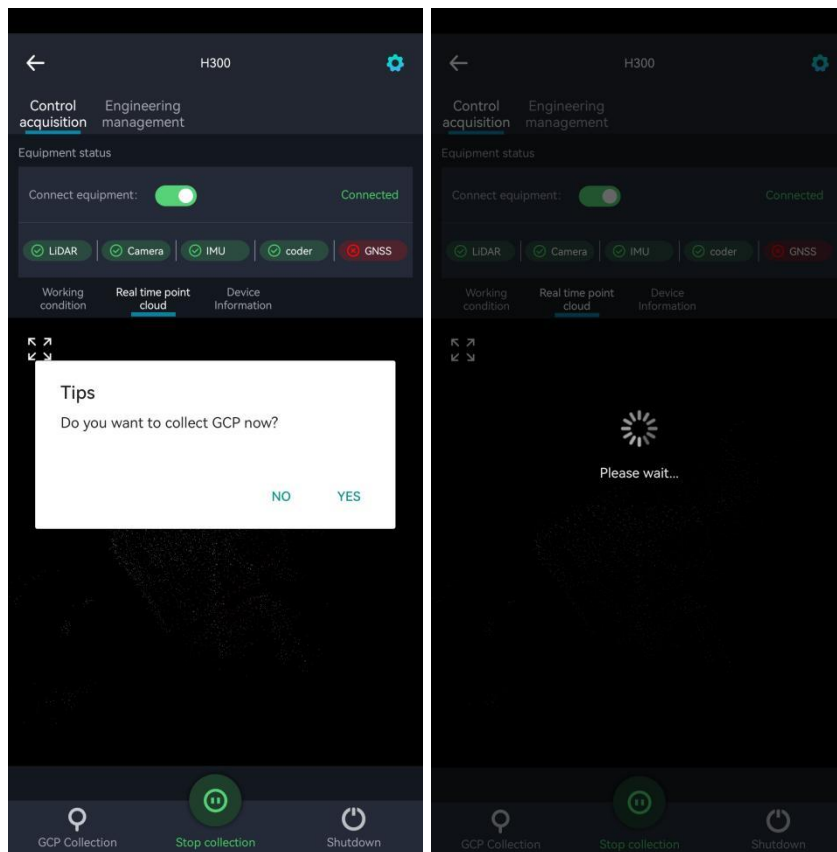



Figure 5-8 Tapping GCP collection on the APP

③ After the indicator changes to **slow flashing** again, use the device to collect data continuously.

④ After the collection of GCP by using the handheld device ends, the on-site operation personnel shall measure the GCP by using GNSS-RTK or Electronic Total Station.

 **Keep steadily when collecting GCP. There should be no people gathered around.**

 **The flashing state indicates that the system has received the command to collect the GCP. If the indicator does not flash after pressing the button, press it again.**

At present, the backpack kit does not yet support the GCP collection.

5.1.1.5 Stopping Collection

- ① Move in figure-8 trajectory in the open area (for **backpack kits, vehicle kits, or airborne kits** only).
- ② Place the device on the ground or on a platform and keep it steadily in place.
- ③ Tap "**Stop collection**" in the app. Follow the prompts on the interface and voice to stop collecting data. When the laser stops rotating, the LIDAR data will stop collection. After the laser stops rotating, the camera will automatically stop recording. The indicator will flash continuously and then is always on. The data will be saved. When the progress bar for saving data disappears, the APP announces "Data saved" in voice. You can collect data of the next project.

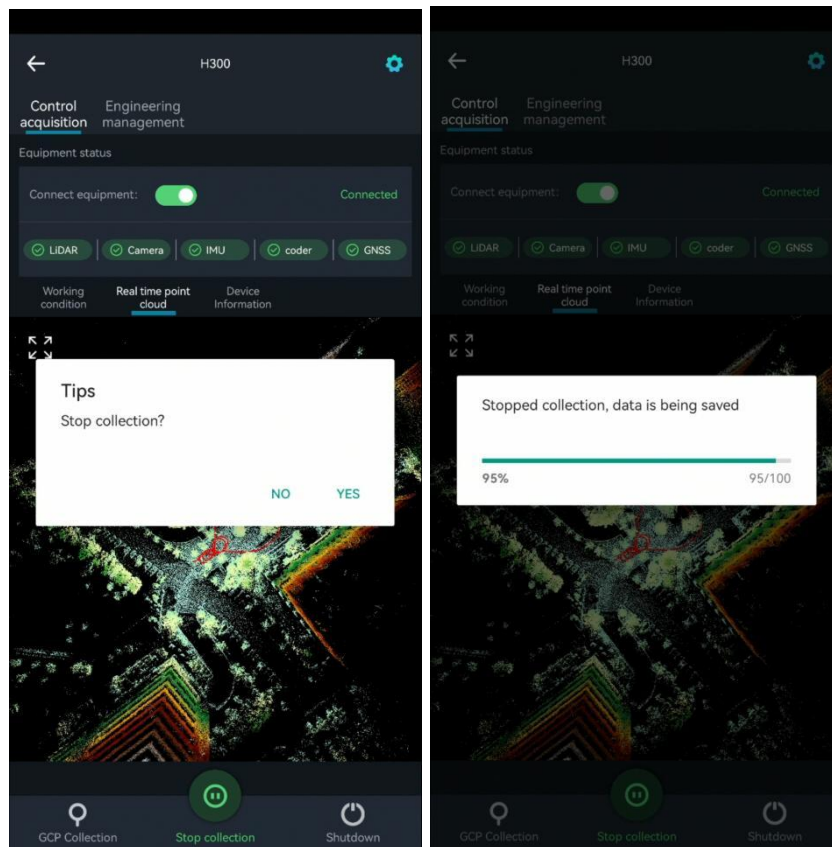



Figure 5-9 Stopping collection and saving data

You can also continue to collect data. For details, see [section 5.1.1.2](#)

 **You must wait for the indicator changing from green to rapid flashing. After the indicator is always on, you can turn off the device.**

 **The camera starts recording video *automatically*. The manual operation is not required. Otherwise, color attachment disorder may occur. The camera also stops recording *automatically* when the collection ends. It is unnecessary to manually stop the recording.**

For detailed information on the use of the APP, see the APP user manual.

5.1.1.6 Device Power-off

Short-press and long-press the battery button in the compartment to power the device off.

5.1.2 Button-based Operations

5.1.2.1 Initialization

(1) Keep the device on a stationary ground surface or platform

When the device is stationary on the ground or on a platform, try to keep the level bubble centered.

Please refer to Section 5.1.1.2 for detailed precautions in this process.



The battery compartment of the device should be placed as close as possible to the main unit of the handheld device. Otherwise, the camera will not start recording automatically

(2) Device power-up

Short-press the battery for 1s and then press for 2s to power it up.



Figure 5-10 Device power-up

(3) Camera power-on



Short-press the black button to turn on the camera. The camera screen lights up

and the camera indicator turns light blue.



Figure 5-11 Camera power-on

(4) Device power-on

After the device power-on, the main unit button flashes rapidly. In this period, the camera will take a selfie (there will be a clicking sound) and the indicator light will turn on. The whole process takes about 30S.



Figure 5-12 Rapid flashing to always-on

(5) Device initialization

Long-press the main unit **green-button** until it **flashes**. Then, release the button. Keep

the device unmoved. The laser starts initialization. After a period of time, the camera **automatically** starts recording (the camera indicator changes from light blue to red). The laser rotates at a constant speed and builds the base image. The button indicator flashes rapidly in the whole process.

After the indicator changes from **fast flashing** to **slow flashing**, the device initialization ends.



Figure 5-13 Long-press the button for initialization



Figure 5-14 Starting recording on the camera automatically



The camera starts recording video automatically. The manual operation is not required. Otherwise, color attachment disorder may occur. The camera also stops recording automatically when the collection ends. It is unnecessary to manually stop the recording.

5.1.2.2 Data Collection

Data collection is carried out according to the route planned in advance. See [03 Path Planning, Zoning, and Control Point Planning](#).



The video collection mode supports video recording mode and time-lapse photography mode. Users can select as required.

It is recommended that the collection time for video recording mode **does not exceed 30 minutes**, and the collection time for time-lapse photography mode **does not exceed 60 minutes**.

5.1.2.3 GCP collection

① Align the "cross" hole of the GCP base with the control point and place the device firmly;



Figure 5-15 GCP collection (Align the "cross" hole with the control point)

② Short-press the main unit button and wait a few seconds. When the indicator

changes from a slow flashing to a fast flashing, collect the GCP once.



Figure 5-16 Short-pressing the green button (indicator: slow flash-> fast flash (collecting GCP); Fast Flash-> Slow Flash (finished))

③ After the indicator changes to **slow flashing** again, use the device to collect data continuously.

④ After the collection of GCP by using the handheld device ends, the on-site operation personnel shall measure the GCP by using GNSS-RTK or Electronic Total Station.

 **Keep steadily when collecting GCP. There should be no people gathered around.**

 **The flashing state indicates that the system has received the command to collect the GCP. If the indicator does not flash after pressing the button, press it again.**

At present, the backpack kit does not yet support the GCP collection.

5.1.2.4 Stopping Collection

Place the device on the ground or platform, and keep it steadily. **Long-press the main unit button until it flashes quickly.** The laser stops rotating and the collection of the LIDAR data ends. After the laser stops rotating, the camera will automatically stop

recording. The indicator will flash continuously and then is always on. The data will be saved.



Figure 5-17 Camera automatically stopping recording when the laser rotation ends

You can also continue to collect data. For details, see section 5.1.2.1.

 You must wait for the indicator changing from green to rapid flashing. After the indicator is always on, you can turn off the device.

5.1.2.5 Device Power-off

Power the battery off by short-pressing and then long-pressing the button.

5.2 Data Collection of Backpack Kit

For the current backpack data collection, only the LiGrip H300 handheld rotary laser scanner controlled by GreenValley APP is recommended.

The current backpack kit supports data collection in PPK mode and RTK mode.

5.2.1 PPK Mode

The Post Processed Kinematic (PPK) is a GNSS positioning technology used in surveying that corrects the location data after it is collected and uploaded. It is a dynamic post-processing surveying technology.

For more information on the use of base stations, see section 04.

5.2.2 RTK Mode

5.2.2.1 Initialization

To start collection, select an open initialization area with distinctive features. Keep the level bubble centered as far as possible, and make it stationary and steady by hand.

Requirements:

- a. Choose a steady and solid ground surface or platform
- b. If GNSS signals are accessed, ensure good conditions for searching satellites (usually greater than 20).
- c. Avoid strong electromagnetic interference in the vicinity.
- d. Do not initialize in areas with heavy pedestrian or vehicular traffic.
- e. Do not initialize in open areas.

(1) Keep the device on a stationary ground surface or platform

The device is stationary on the ground or on a platform.



Figure 5-18 Placing on the ground or platform

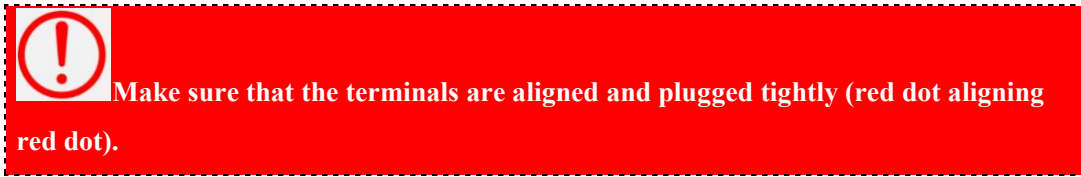

(2) Device power-up

Short-press the battery for 1s and then press for 2s to power it up.

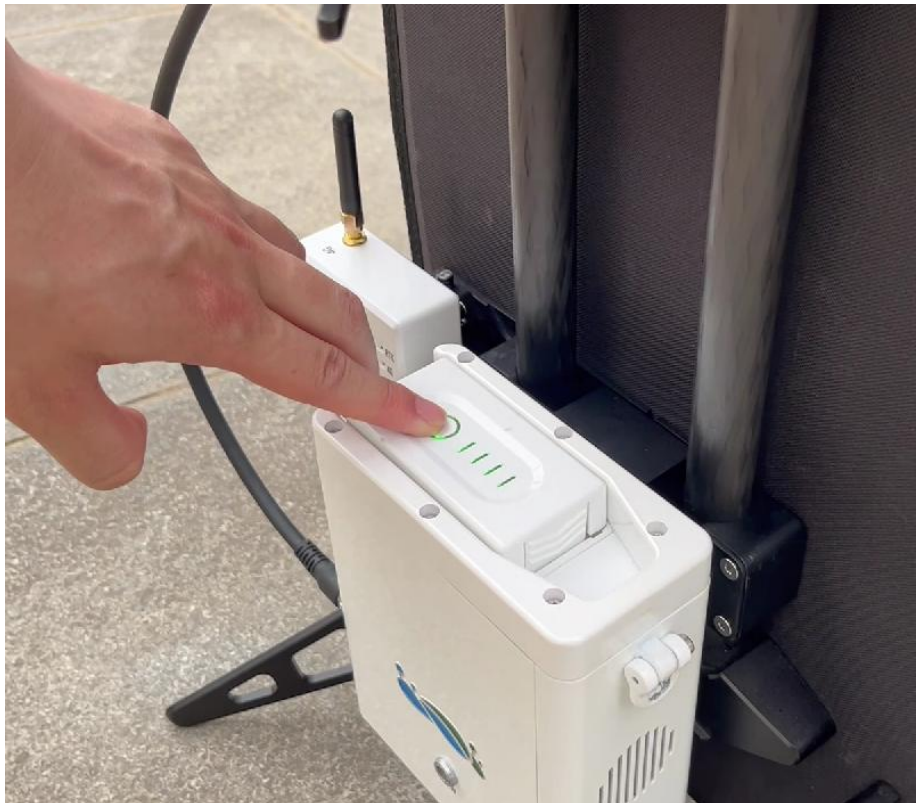

Figure 5-19 Device power-up

(3) Camera power-on



Short-press the black button  to turn on the camera. The camera screen lights up and the camera indicator turns light blue.



Figure 5-20 Camera power-on

(4) Device start-up

After the device power-on, the main unit button flashes rapidly. In this period, the camera will take a selfie (there will be a clicking sound) and the indicator light will turn on. The whole process takes about 30S.



Figure 5-21 Rapid flashing to always-on

5.2.2.2 RTK Mode

The LiGrip H300 can be equipped with a GNSS module. It supports both PPK mode and RTK mode.

The RTK mode requires a CORS account before you can log in to the CORS network to obtain real-time differential data. If you do not have an available CORS account, the RTK function of the GNSS module will not be available. The GNSS module only supports the RTK function in CORS mode.

If you already have an available CORS account, set it up as follows:

① Move to an open area for searching satellites. Make sure that the device is connected properly and switched on. The device is powered on after the battery is ON. The camera needs to be switched on separately by pressing the on button.

② Connect App to the device corresponding to SN. The App prompts that each sensor of the device is normal (√)

③ Tap  Settings at the top right corner of the app to set the RTK link.

④ Enter your service information (domain IP, port, account, and password).

(1) Data link: By default, it is host network.

(2) Communication protocol: By default, it is CORS.

(3) Server: Currently, there are built-in Huace server, Qianxun server, and China mobile server. It supports the custom.

(4) Domain name/IP address: Refers to the domain name/IP address of the current login CORS account. Servers vary with domain names/IP addresses.

(5) Port: User can select/enter different ports according to the actual CORS requirements.

(6) Source List: Users can select/enter different source lists according to different differential requirements.

(7) User name/password: Refers to the CORS account and password for logging in to the server.

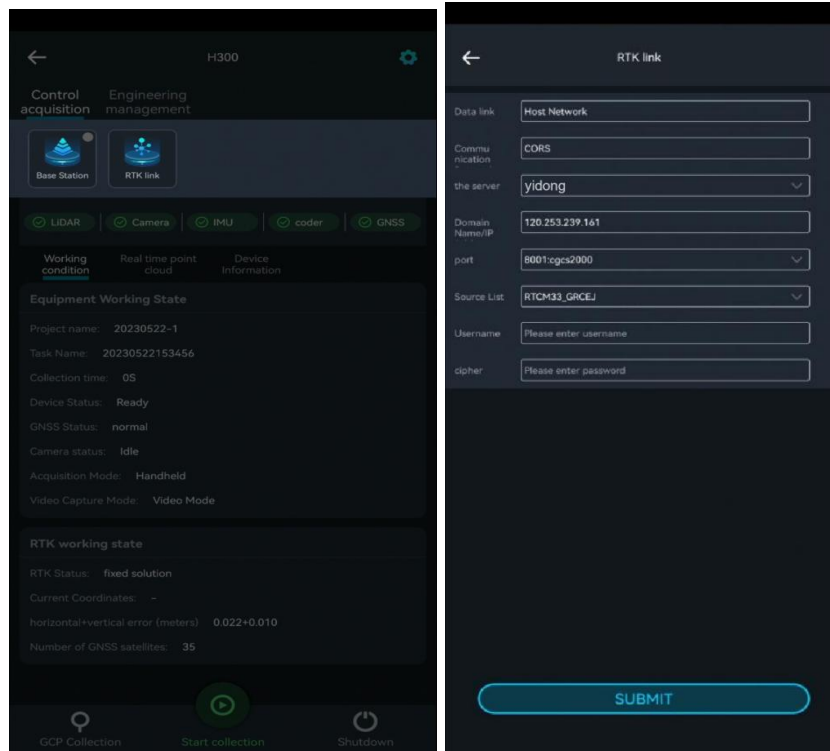

Figure 5-22 RTK link configuration

⑤ Tap Submit to start to log in to the service. After the successful login, the prompt is as follows:

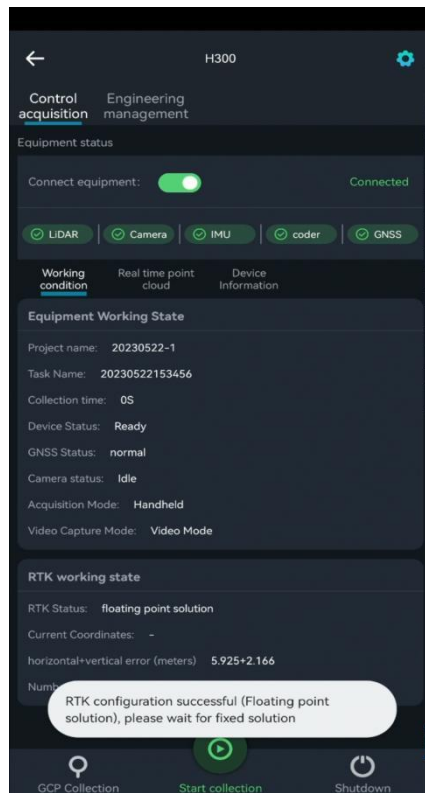

Figure 5 -23 RTK link configured successfully

After the RTK module is successfully configured, it will prompt with broadcasting "RTK configuration is successful" in voice. At this time, the RTK indicator on the RTK module is always on, the 4G indicator is always on, and the POW indicator is always on. The RTK status bar will display the current RTK status and latitude and longitude coordinates of the device (If the user sets the coordinate system, the plane coordinate is displayed; If not, the latitude and longitude are displayed).



Figure 5-24 Indicator always on in case of successful RTK link configuration

RTK status bar: Displays RTK module real-time status information. The current RTK states include fixed solution, floating solution and single point solution.

	RTK Status	Explanation
①	Fixed solution	Indicates that the real-time RTK module has high positioning accuracy and the device meets the RTK data collection requirements.
②	Floating solution	Indicates that the satellite signal received by the RTK module at the current location is not good and there may be an obstruction nearby. Wait for the device to be fixed, or move the device to an open, unobstructed area with a good satellite signal and wait for the device to be fixed.
③	Single solution	Indicates that the RTK module at the current location is unable to receive satellite signals, or the satellite signal is poor. It is recommended to configure the RTK module in an open and unobstructed area.



Before data collection, ensure that the device has sufficient storage space. Free up the storage if necessary.

5.2.2.3 Starting Collection

After successful RTK configuration in the GreenValley APP, wait until the **Laser**, **Camera**, **IMU**, and **Coder** turn **green** ✓ (**red** ✗ means the module is abnormal. In this case, check whether the device is turned on normally). Wait for the device to search satellites. When the number of satellites is greater than 20, tap Start collection.

Tap the "Start collection" key in the GreenValley App to enter the "New Project" page. The GreenValley APP supports the creation of multiple sub-tasks under one project. Set the project name, collection location, notes, and coordinate system. The coordinate system can be selected according to the actual geographic location. Tap OK. The new project settings are completed. Select the appropriate project file, and fill in the actual work area information in the start collection interface. The sub-task project is created completely. The device starts to enter the initialization state. Wait for the APP device status to change to "Collecting". The APP prompts "device is collecting" via voice. Then, start data collection according to the planned route.

Note: The camera can be switched on by pressing the black button. If it is unnecessary to collect camera video, the power-on is not required. At this time, the camera status is displayed as red ✗. After the collection starts, the camera will automatically start recording, and the camera will automatically end when the collection is finished.



The video collection mode supports video recording mode and time-lapse photography mode. It is recommended that the collection time for video recording mode does not exceed 30 minutes, and the collection time for time-lapse photography mode does not exceed 60 minutes.



After the RTK module has been successfully configured, the RTK status bar will indicate the RTK state, current position and plane + elevation error (in meter). At this time

the device is stationary on the ground, so there are no coordinates in the current status. The current coordinate values will be displayed only after the collection starts.

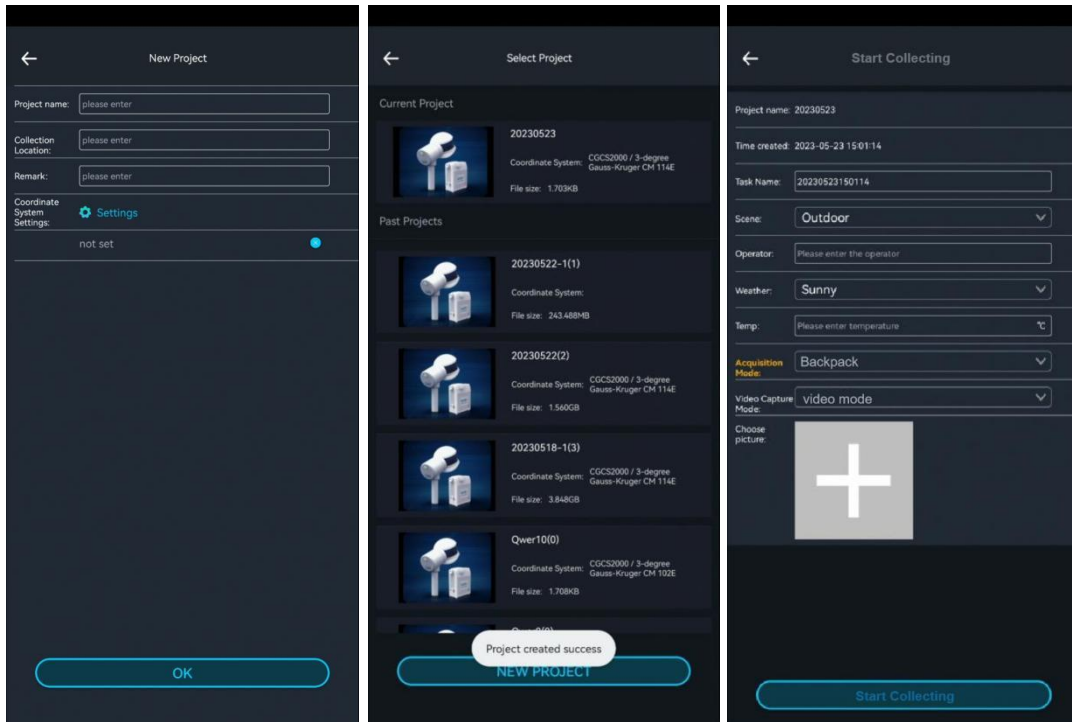

Figure 5-25 New project and sub project

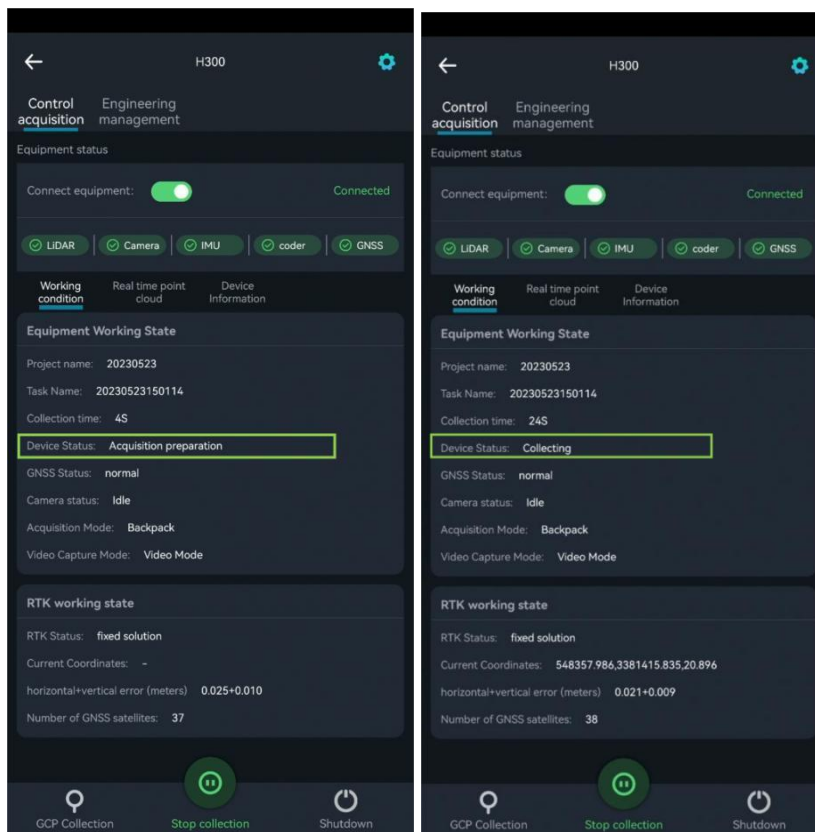

Figure 5-26 Backpack kit data collection in progress

5.2.2.4 Figure-8 (only for backpack, vehicle and airborne kits)

When the APP announces that the device status is collecting data in voice (or check the device status in the APP working status bar), slowly pick up the device and move according to the planned route. Do not make significant arm movements during the walking process. The speed should be ≤ 1 m/s. Real-time trajectories and point clouds can be viewed using the APP.

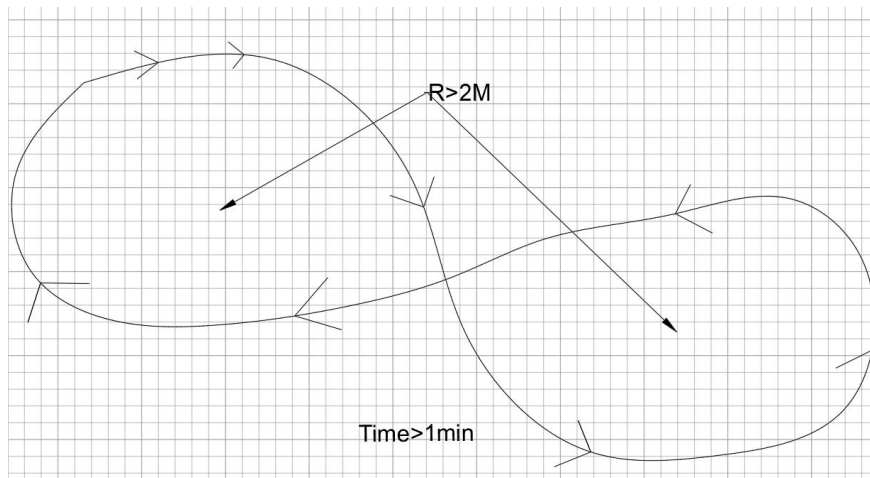



Figure 5-27 figure-8 trajectory (imu alignment)

 **Note: When collecting data with GNSS accessible modules such as backpack kits, vehicle-mounted kits, and airborne kits, make sure to keep the device to move in figure-8 trajectory before data collection.**

5.2.2.5 Data Collection

After the movement in figure-8 trajectory ends, follow the pre-planned route to collect data.

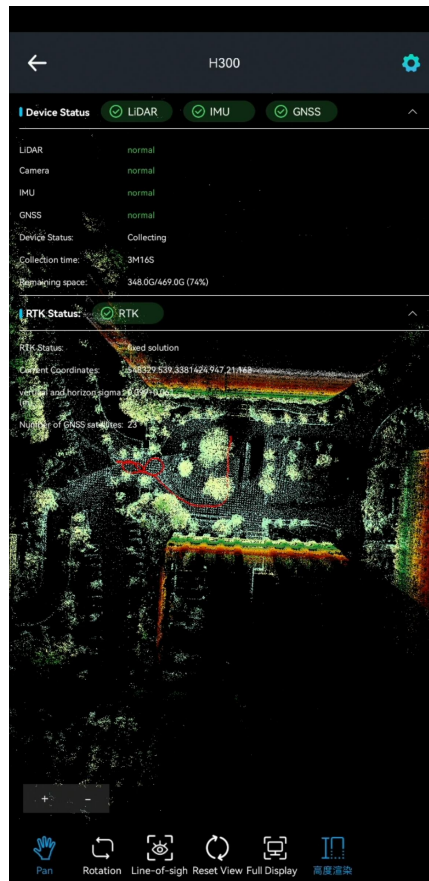

Figure 5-28 Data collection according to the route planned in advance

Note: For detailed path planning, see section 03.

5.2.2.6 Stopping Collection

- (1) The movement in figure-8 trajectory is performed in an open area. It takes approximately 1 minute with a radius of not smaller than 2 m. The operation is the same as described in section 5.2.2.4.
- (2) After the movement in figure-8 trajectory, the device is placed slowly on the ground or on a platform.



Figure 5-29 Slowly remove the device and place it on the ground when the collection stops

- (3) Tap "Stop collection" in the app. Follow the prompts on the interface and voice to stop collecting data. When the laser stops rotating, the camera automatically stops recording. The progress bar for saving data disappears and the APP announces "data saved" in voice. Then, you can continue to collect data in the next project.

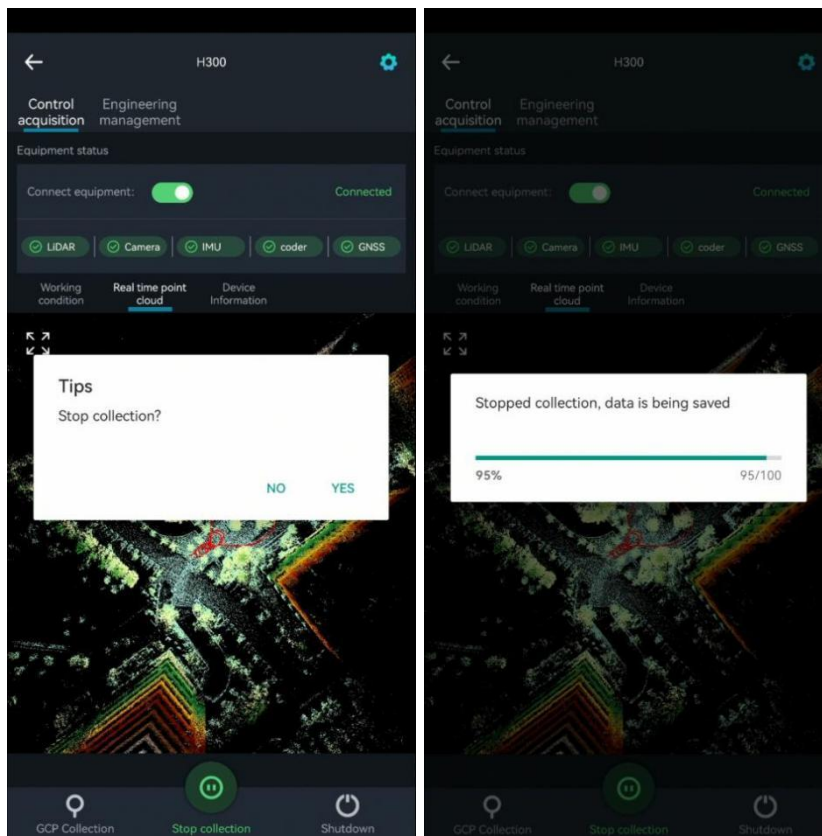

Figure 5-30 Stopping the recording and saving data

If you need to continue to collect data at this time, start operations directly. For details, see section 5.2.2.3.

If you want to end the collection, switch off the reference base 10 minutes after the collection by using the handheld device ends.

Note: When the collection stops, it is recommended to slowly place the backpack kit on the ground or platform. Tap the Stop collection button.



After tapping Stop collection, continue to remain stationary. Walk around at will after the laser stops rotating (the camera will automatically stop recording video data after the laser stops the collection).



You must wait for the indicator changing from green to rapid flashing. After the indicator is always on, you can turn off the device.

5.3 Things to Keep in Mind

5.3.1 For Data Collection in Outdoor Scenario

- (1) Keep a walking speed of 1 m/s.
- (2) If you encounter moving vehicles or people during collection, change the orientation of the unit so that the radar is facing the stationary objects. Wait for the vehicles or people to pass and then continue along the normal collection route;
- (3) If the collection scenario has too many swaying plants and trees, usually in windy weather, avoid collecting at that time. Do not cut through areas with heavy grass and trees.
- (4) Do not follow vehicles or crowds of people for your survey.
- (5) If you reach a dead end, it is recommended that you do not change the direction of the handheld unit. Hold the tool in the other hand and then step outside.
- (6) Do not collect data at times when there is a high volume of pedestrian and vehicle traffic.

5.3.2 For Data Collection in Indoor Scenario

- (1) When collecting data indoors, please walk slowly and turn at 30 degrees/second.
- (2) Follow a U-turn. Do not turn on the spot.
- (3) Leave the door open beforehand. Do not move during the measurement.
- (4) When entering a space from another space:

On the entry, first scan the house outside in its entirety and then walk slowly through the door. Once you have scanned the objects in the room, leave the room or turn around slowly to leave the room in the normal way.

5.3.3 For Data Collection in Mine/Tunnel Scenarios

- (1) Initialize in an open area.
- (2) Move straight ahead when collecting data. This will allow the laser to scan a wider area.
- (3) Do not hold the laser too close to the ground or walls. A minimum distance of 20-40cm should be maintained.
- (4) When collecting data in scenarios such as tunnels and mines, it is not recommended to reverse along the original road. Make sure you collect data on both sides of the road. That is, The data is collected once on one side. You will be able to reduce some of the cumulative error by following an S-shaped path.

CHAPTER

6

06 Data Copy

- Introduction to the Project File
- Copying LiDAR data via APP
- Copying LiDAR data by using network cables
- Copying camera files
- Copying base station files

6.1 Introduction to the Project Files

The project data files collected by the current device contain many items. See the figure below. The project folder of the target data contains several subfolders that have been collected, as well as the project.json file, where the subfolders contain the IMG folder, the RealTimeResult folder, the .bag/.log/.rotlog/.rtk files, and the mission.json file (recording the project information for the subfiles).

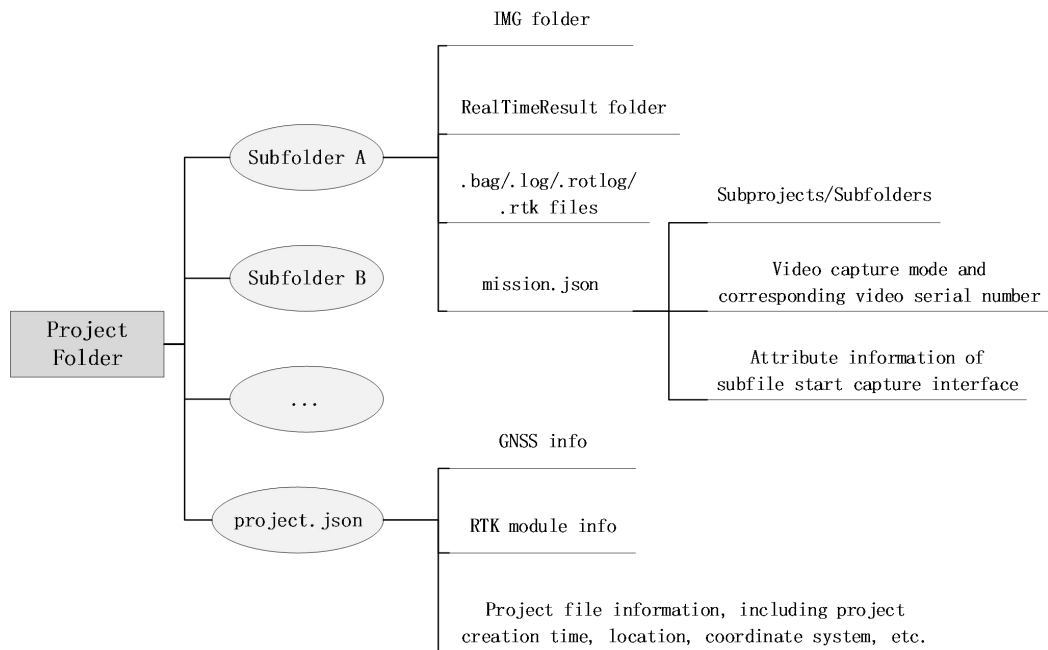

Figure 6-1 Project file structure

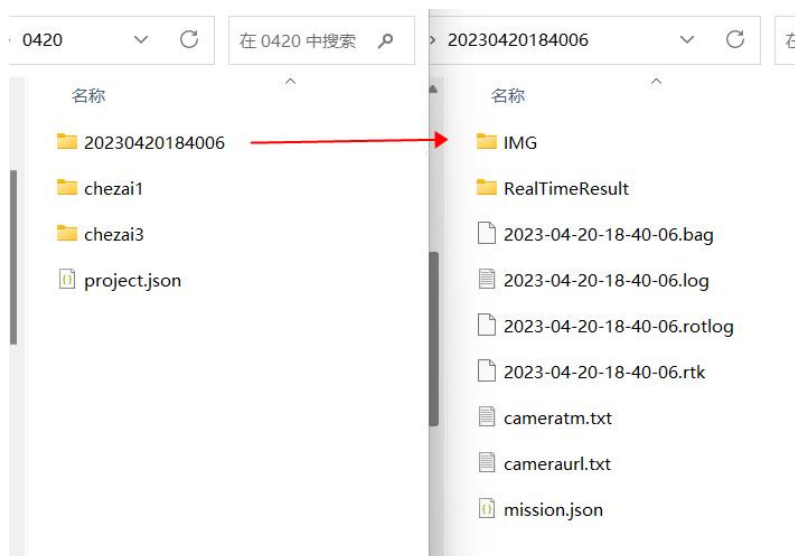

Figure 6-2 Project and folder details

6.2 Copying LiDAR Data via APP

Insert a USB flash drive into the USB port of the device. Tap a project in the project list. The system prompts to copy the project to the USB flash drive. You can also long-press to select multiple projects and tap Copy to copy the data to the USB flash drive. A progress bar will be displayed during copying. Wait until the progress bar reaches 100%. The message "Project copy successful" will then appear. Tap OK and then remove the USB flash drive.

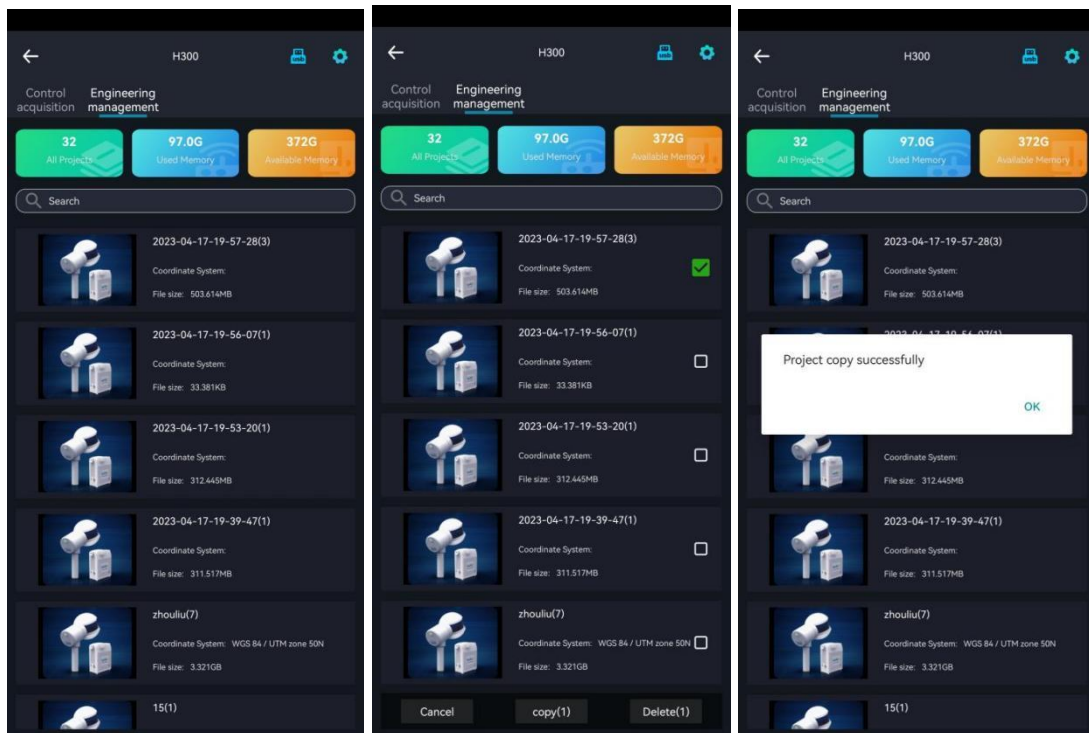



Figure 6-3 Copying data via APP

For more details about the copy on the APP, see the APP user manual of GreenValley.

6.3 Copying LiDAR Data by Using Network Cables

Insert the battery and power the device up. Connect the Lemo port end of the data transmission cable to the LAN port, and the other end to the computer.

 **IP address:192.168.1.99 Subnet mask: 255.255.255.0**

Enter the URL "\\192.168.1.200" on the computer to access the internal storage space of the device. Open the "share" folder. Go to the custom project directory or the folder named by time, and copy all the files to complete the data export.

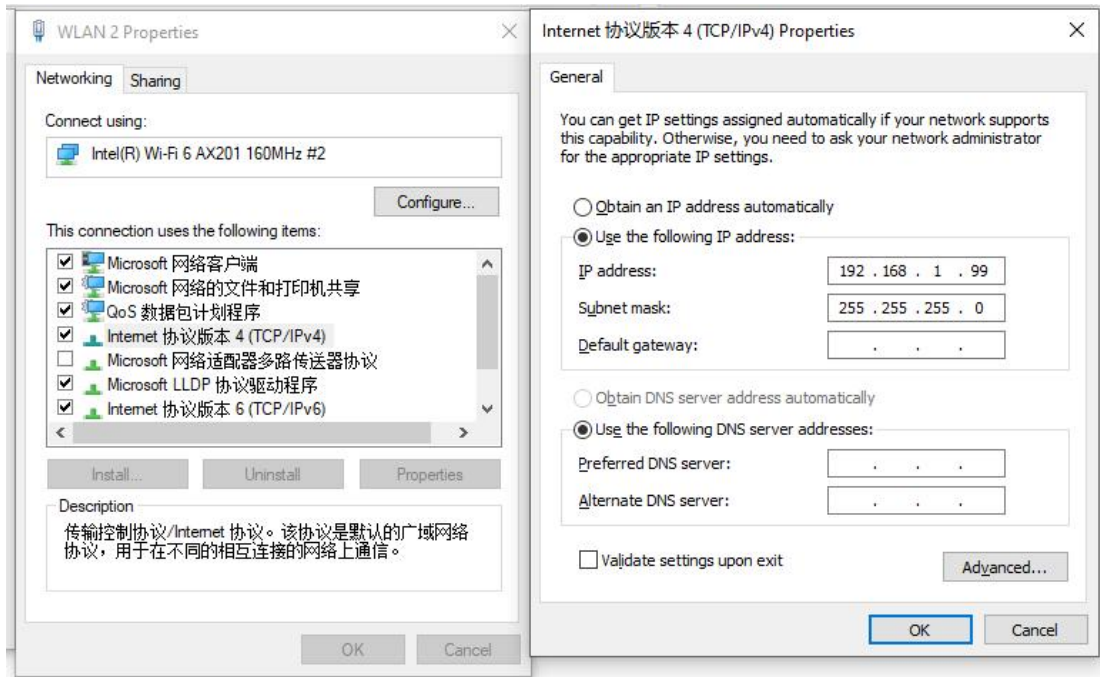

Figure 6-4 IP settings

If username and password are required, enter the following information:

Username: share

Password: 11111

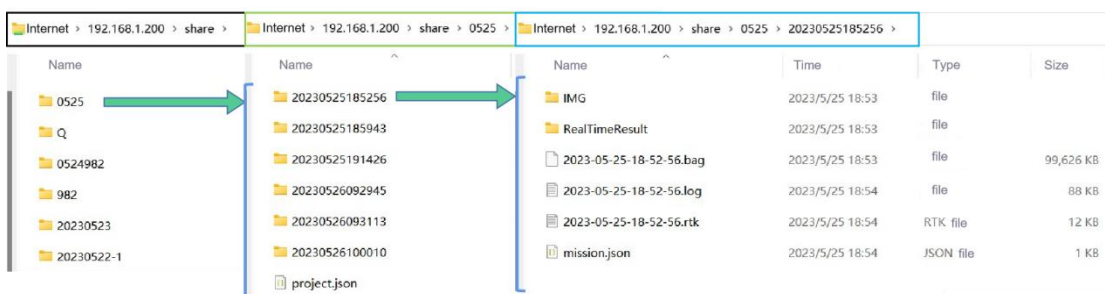

Figure 6-5 Copying project file via LAN port

6.4 Copying Camera Files

- ① Open the **mission.json** file under the copied project data directory. It

contains the subproject folder information and the names of the video files corresponding to the subproject file.

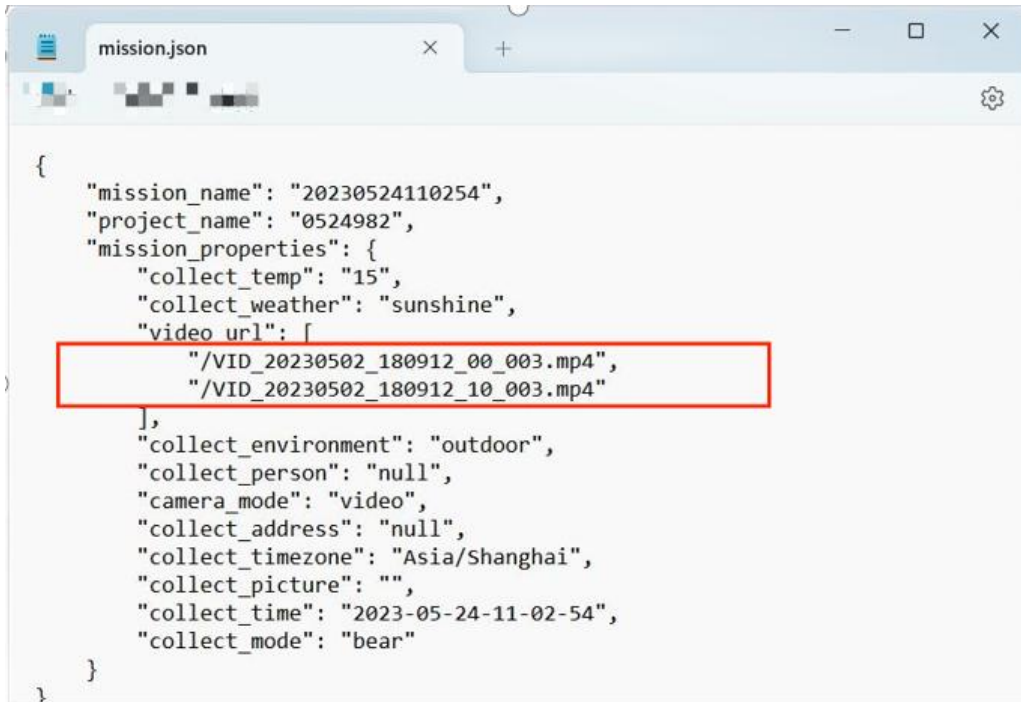

Figure 6-6 mission.json recording the video name of subproject

② Use a TypeC-USB cable to connect one end to the camera's TypeC port and the end to the computer's USB port. Power on the device by pressing the battery. At this time, the camera is in USB flash drive mode. Copy the corresponding video file. (Copy video files with the prefix of **VID**)

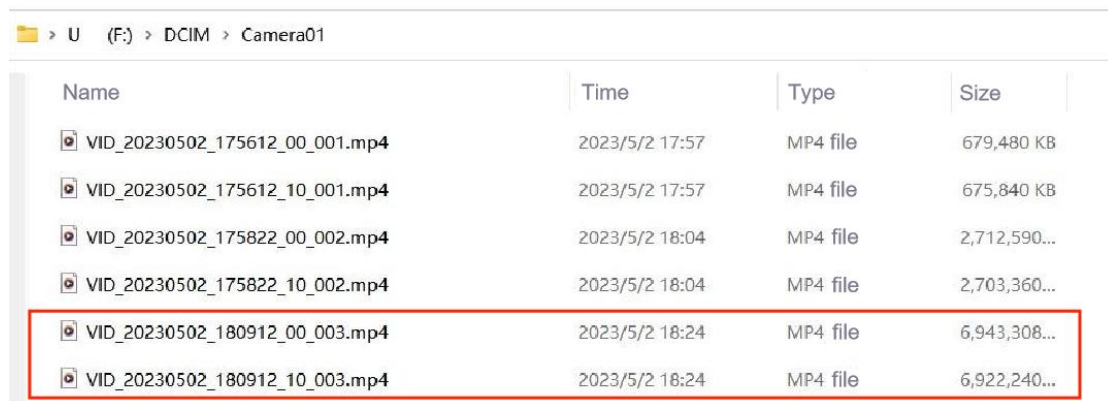



Figure 6-7 Copying the corresponding video data recorded by the camera

 **Note:** The **mission.json** file in the subproject folder records the corresponding

video file names of the project! Only the two video files starting with VID should be copied.

The copied camera files can be moved to the IMG folder in the subproject folder or moved to the .bag files under the same sub-folder.

6.5 Copying Base Station Files

6.5.1 Copying Base Station Files

Use the data cable to connect the physical base station device and download the reference station data (PPK mode).

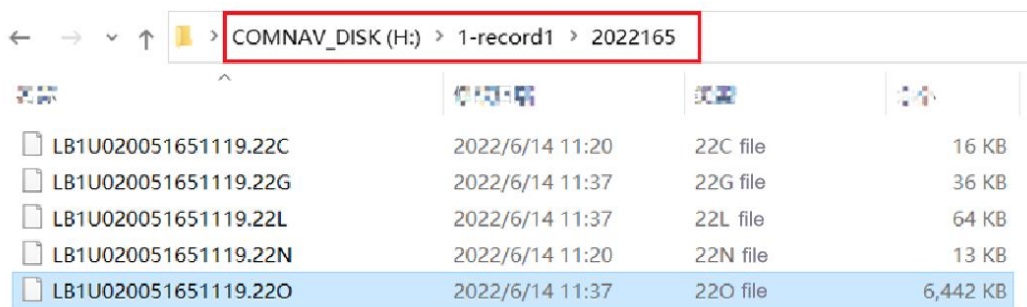

Figure 6-8 Base station data copy in PPK Mode

6.5.2 Downloading Virtual Base Station Files (Applicable in China)

It is recommended to use Google Chrome to open the LiCloud platform (URL: <https://licloud.lidar360.com/#/>) After registration, log in to the account.

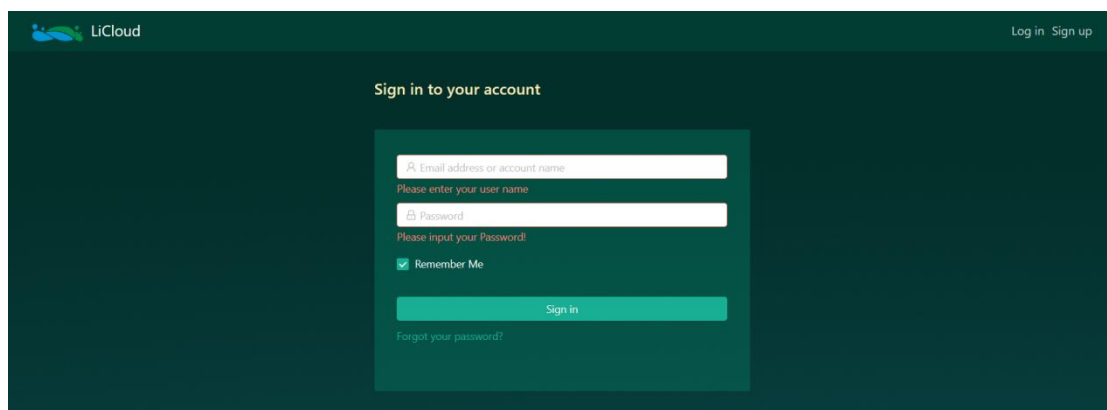

Figure 6-9 LiCloud login

After logging in, tap Green Soil Cloud Trace to view the type of base stations used by the user. If the user has the virtual base station permission, tap the virtual base station to view the created task name, start time, end time, result file, and task status.

Click the result file corresponding to the virtual base station set up by the user to download the virtual base station file.

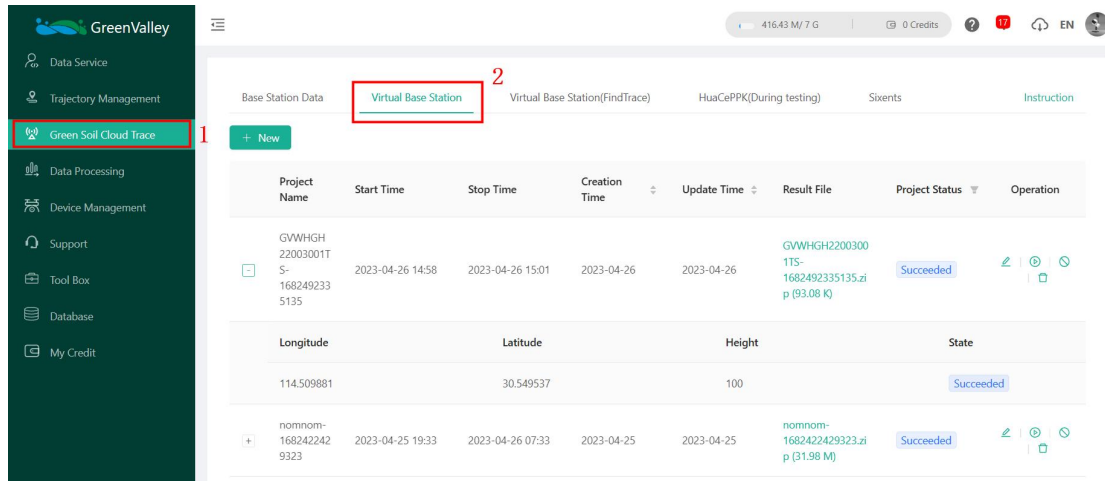



Figure 6-10 Downloading data on virtual base station



The task status includes the setup state of the virtual base station.

Succeeded: The virtual base station is successfully set up and the virtual base station data can be downloaded;

Running: The virtual base station is being set up;

Failed: The virtual base station fails to set up.



Note: When using the virtual base station, make sure that the GreenVally app account should be the same as the LiCloud log-in account for downloading data.

6.5.3 Downloading Base Station Files in RTK Mode

After using RTK mode for data collection, the device will automatically store a .rtk file in the subproject file, which records the location information of the device.

LiFuser-BP can directly import this data when solving RTK data.

20230315 > 20230413173724

Search 20230413173724

Name	Date modified	Type	Size
IMG	6/7/2023 10:12 AM	File folder	
RealTimeResult	6/7/2023 10:13 AM	File folder	
2023-04-13-17-37-24.bag	4/13/2023 5:54 PM	BAG File	2,638,717 KB
2023-04-13-17-37-24.jpg	4/13/2023 5:38 PM	JPG 图片文件	37 KB
2023-04-13-17-37-24.log	4/13/2023 5:55 PM	Text Document	3,961 KB
2023-04-13-17-37-24.rotlog	4/13/2023 5:54 PM	ROTLOG File	1,783 KB
2023-04-13-17-37-24.rtk	4/13/2023 5:55 PM	RTK File	211 KB
cameratm.txt	4/13/2023 5:38 PM	Text Document	1 KB
cameraurl.txt	4/13/2023 5:39 PM	Text Document	1 KB
mission.json	4/13/2023 5:54 PM	JSON File	1 KB

Figure 6-11 RTK mode base station data

CHAPTER

7

07 Data Processing

- Data preparation
- LiFuser-BP new project
- Project processing
- GCP adjustment
- Data quality judgment

The following GNSS data is from the backpack kit.

7.1 Data Preparation

① GNSS base station data:

- I. Static data collected by the field GNSS receiver (if available);
- II. Base station point coordinates and antenna phase height (if available);

If necessary, static data need to be converted to standard RINEX format (o-file and p-file)

② LiDAR data: bag file

③ GNSS mobile station data: log file (if available)

④ RTK mode storage data: .rtk file (if available)

⑤ Camera data: mp4 file corresponding to the bag package. **It is unnecessary to modify the mp4 suffix to insv.**

⑥ Absolute coordinate file (txt file) of the GCP location;

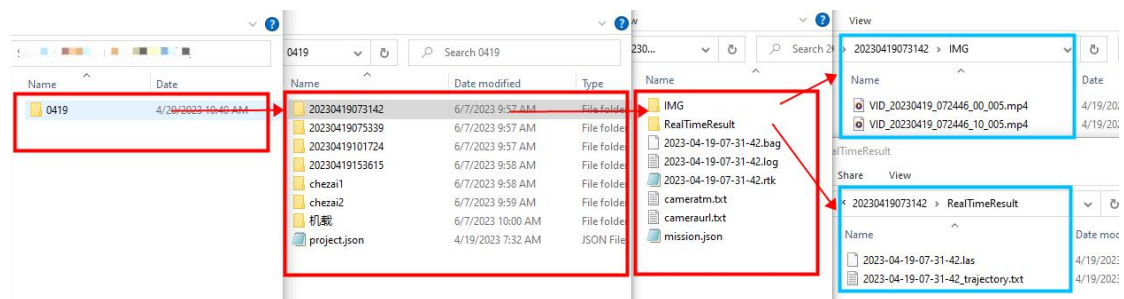

Figure 7-1 Data folder details and camera video preparation



In the LiGrip H300 data processing, you do not need to change the suffix **.insv** of the video file (**.mp4**). You just need to store the video file in the corresponding IMG folder. The new version of LiFuser-BP software can automatically read the video file and complete the video editing without a third-party software.

7.2 LiFuser-BP New Project



The H300 data processing uses the LiFuser-BP developed by GreenValley

7.2.1 Importing Original Data

Tap **New** -> **Backpack**.

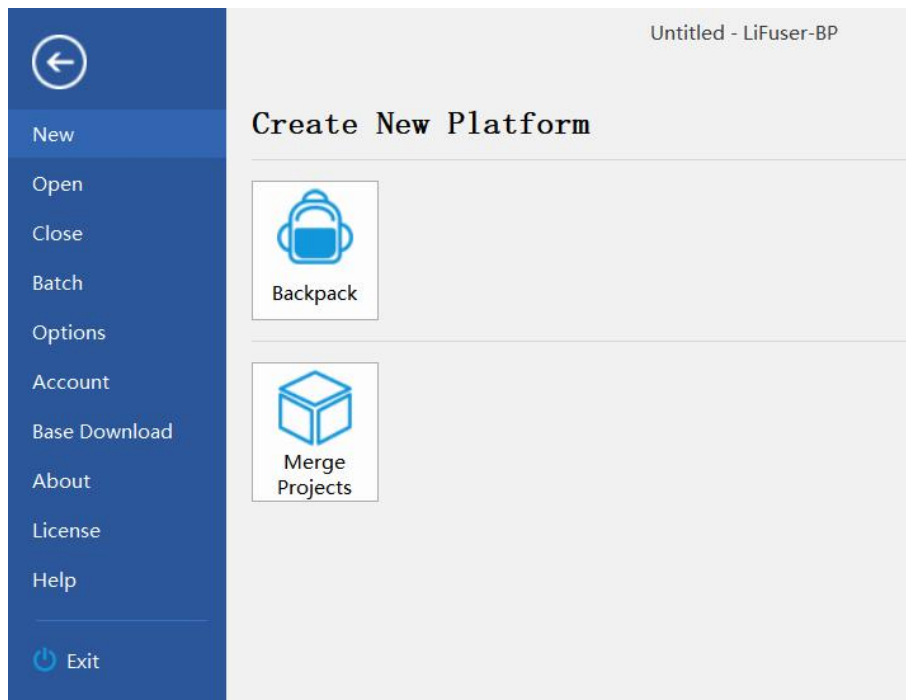

Figure 7-2 New backpack project

Set the LiDAR bag path and video IMG folder (it is recommended to store the captured video files inside the IMG file).



Figure 7-3 Setting .bag and .mp4 path

7.2.2 GNSS Configuration (for backpack kits, vehicle-mounted kits, and airborne kits only)

Configure GNSS mobile station data and base station data (if no GNSS data is available, deselect "Process GNSS"). On the GNSS configuration page, you can flexibly select according to the base station mode in the LiGrip H300 data processing.

7.2.2.1 PPK Mode

In GNSS mode, select **Differential GNSS**, select the **.log file** in the subproject file for mobile station data. Select the **RINEX** format for base station data, and enter the **OBS** file of the base station. The rest of the files can be read automatically by the software. Select the manual input in positioning mode, and manually enter the coordinates of the base station and antenna height in PPK mode. Then, tap Next.

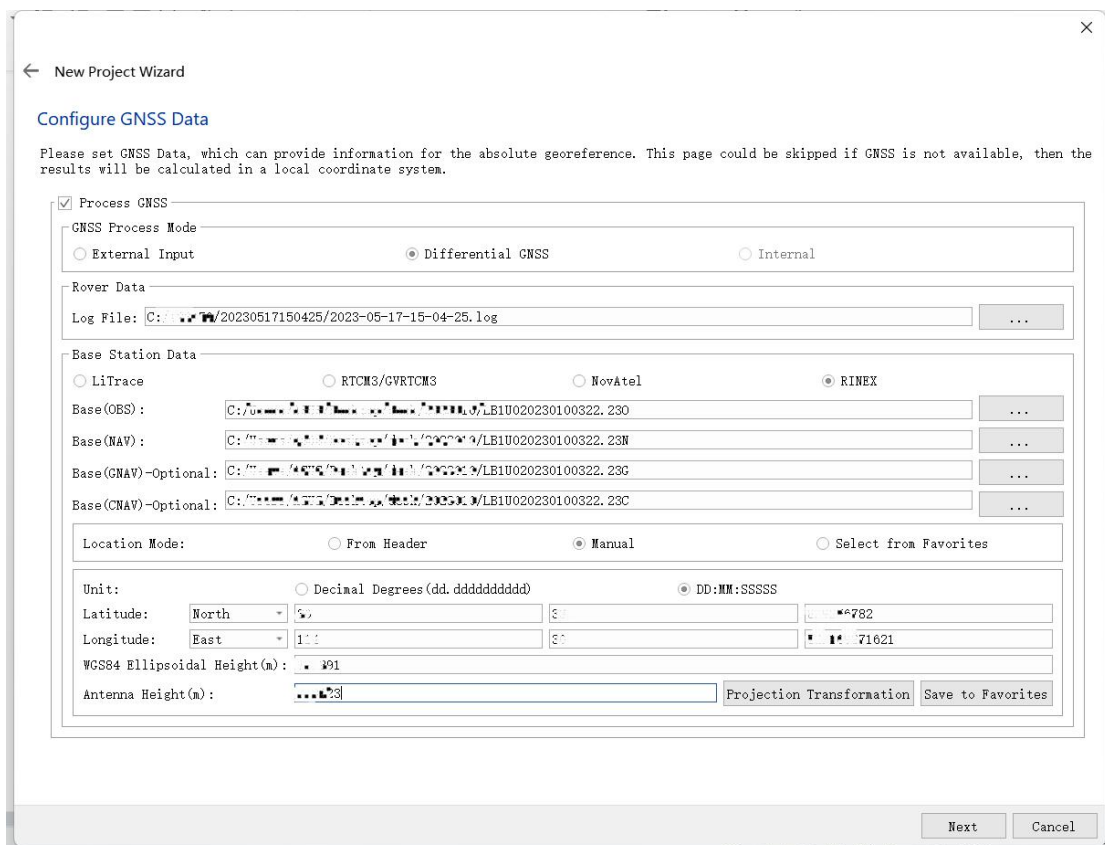

Figure 7-4 Configuring mobile station and base station data

It should be noted that the coordinates of the base station must be entered correctly and the antenna height must be the same as the actual measurement.

If there is no GNSS signal access throughout the field collection process, such as in mines, tunnels or indoors, there is no need to set the GNSS-related options.

7.2.2.2 Virtual Base Station Mode

At present, the data processing of the LiGrip H300 virtual base station mode includes two methods: Green Soil Cloud Trace and RTCM3/GVRTCM3.

(1) Green Soil Cloud Trace (batch processing is not supported at the moment)

The Green Soil Cloud Trace function is applicable to the virtual base station data set up by users in the GreenValley App.



The main advantage of Green Soil Cloud Trace function: Users do not need to log in to the LiCloud platform. Users can directly use the LiFuser-BP software to download the virtual base station data and solve it. It features simplicity, ease of use, and efficiency.



Note:

- ① This function does not support **Batch Processing** at the moment.
- ② When using this function, you need to log in to your LiCloud account in the account settings, and you will be prompted "Login successful! Select the virtual base station preference option.
- ③ Make sure that the account for downloading base station data and the account for setting up base station is the **same!**
- ④ Please make sure there are enough points in your LiCloud account, BP software will cost you a certain amount of points when you use Green Soil Cloud Trace for processing.

Type	Steps	LiTrace operation result
1	① ✓ App virtual base station erection ② ✓ Check the virtual base station priority ③ ✓ LiTrace solution	The user sets up a virtual base station in the GreenValley APP, and logs in to the LiCloud account and checks the priority of the virtual base station when the BP software solves it. At this time, the BP software will give priority to downloading the virtual base station and bring it into the solution;
2	① ✓ App virtual base station erection ② ✗ Unchecked virtual base station priority ③ ✓ LiTrace solution	If the virtual base station is set up in the APP, but the virtual base station priority option is not checked, the post-event base station will be downloaded when the BP software LiTrace solves;
3	① ✗ The app virtual base station is not set up ② ✓ Check the virtual base station priority ③ ✓ LiTrace solution	If the virtual base station is not set up in the APP, and the virtual base station priority option is checked, the BP software LiTrace will not be able to solve the base station data when calculating, and an error will be reported when running.

Figure 7-5 Note for Green Soil Cloud Trace data processing on the Green Soil App

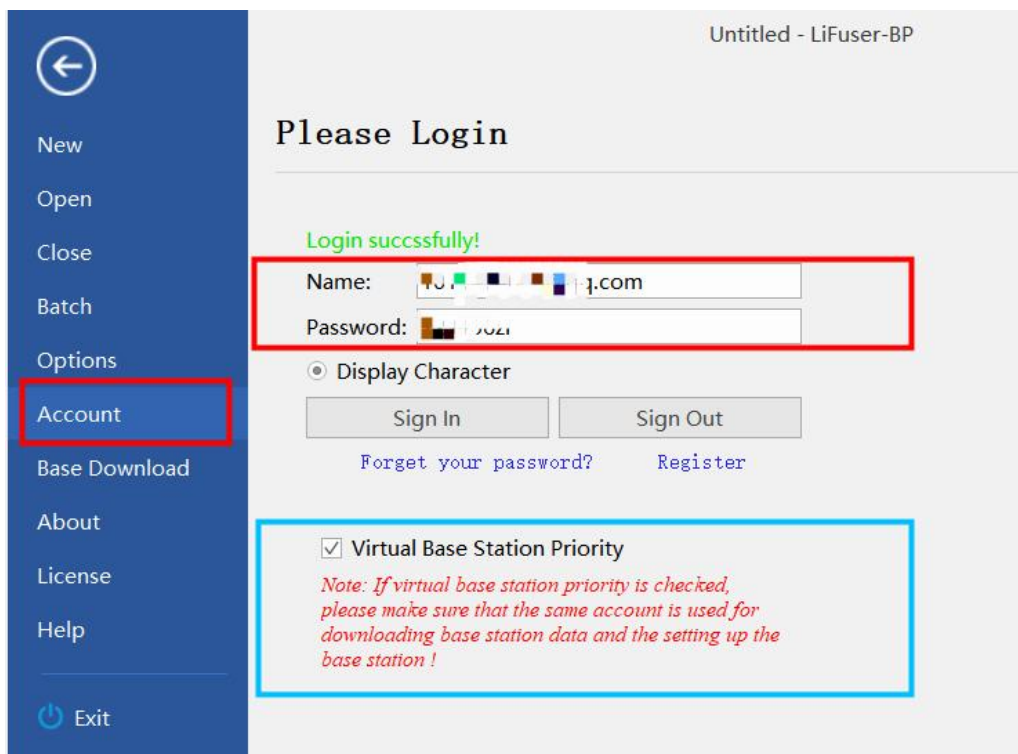

Figure 7-6 LiFuser-BP account login

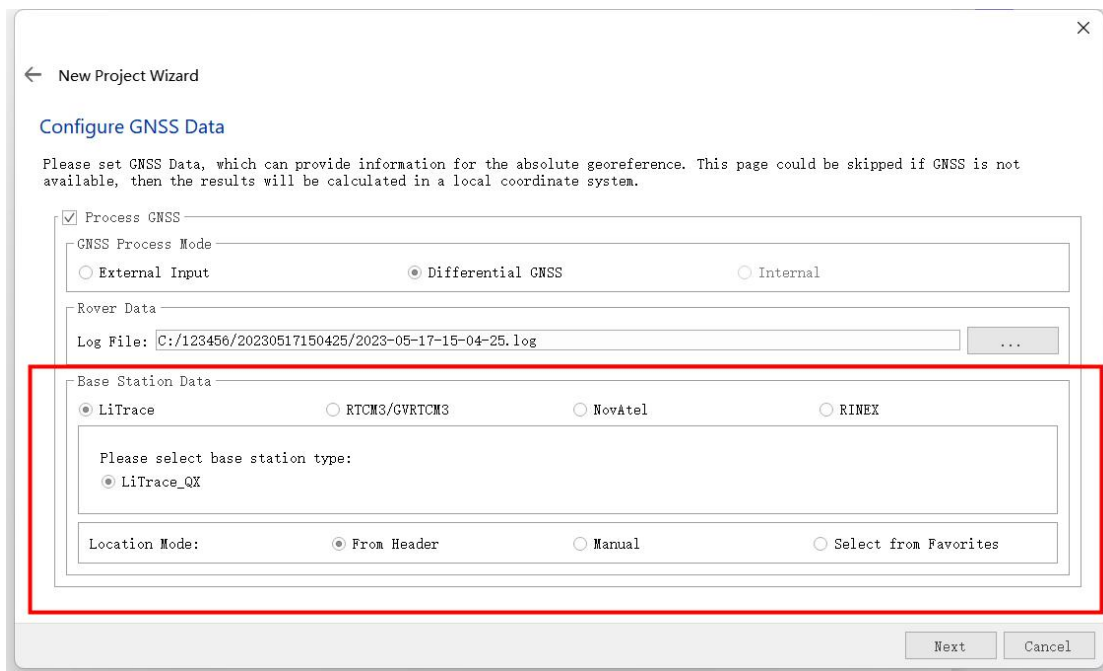



Figure 7 -7 Data processing by Green Soil Cloud Trace

(2) RTCM3/GVRTCM3

RTCM3/GVRTCM3 refers to the downloaded data format of the virtual base station or the data format of other types of base stations.

It is recommended to use Google Chrome to open the LiCloud platform (URL: <https://licloud.lidar360.com/#/>). Tap Green Soil Cloud Trace -> Virtual Base Station -> Result file -> Virtual base station file (.zip file) Tap it to download the .zip virtual base station file. Compress it to get the corresponding virtual base station file.



Difference between RTCM3/GVRTCM3 and Green Soil Cloud Trace for virtual base station processing:

- ① In the RTCM3/GVRTCM3 processing, users should log in to the LiCloud platform to download the virtual base station file package (.zip file).
- ② After decompression, virtual base station data (.rtcm3 or .gvrtdcm3 file) can be obtained;
- ③ Substitute the virtual base station data into BP software for processing.

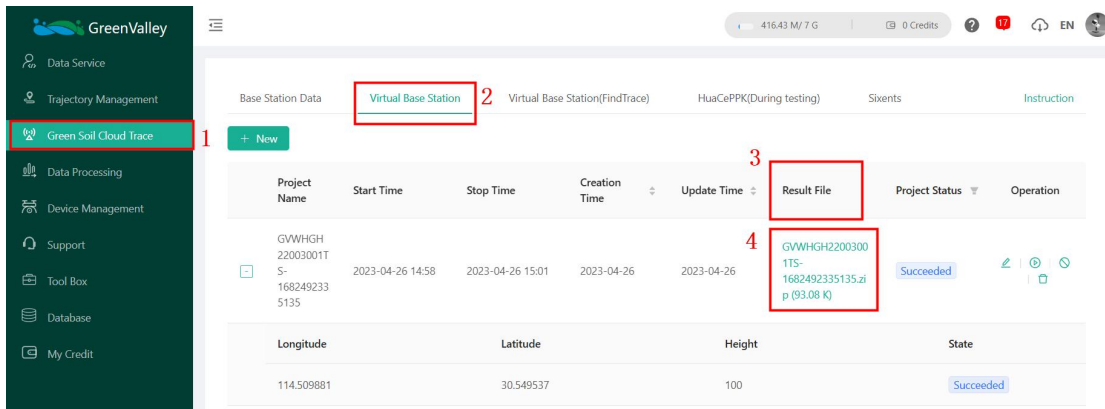

Figure 7-8 Downloading data on virtual base station in LiCloud for RTCM3/GVRTCM3

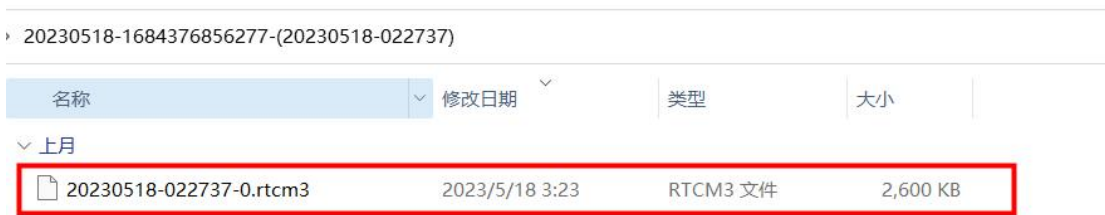

Figure 7-9 LiCloud virtual base station data download and decompression



Figure 7-10 Data processing of virtual base station for RTCM3/GVRTCM3

7.2.2.3 RTK Mode

A .rtk file will be generated in the corresponding subproject folder in the following conditions: 1) The LiGrip H300 uses a backpack kit, vehicle kit or airborne kit to collect data; 2) the RTK link is successfully configured in the GreenValley App; and

3) The RTK is working normally when collecting data.

 When using this mode of data solving, make sure whether the data collection is configured with RTK link, the indicator of RTK module is always on, the RTK status bar displays the **fixed** solution, and the **.rtk** file exists in the subproject folder!

0419 > 20230419101724 >

Name	Date modified	Type	Size
IMG	6/14/2023 7:37 PM	File folder	
RealTimeResult	6/7/2023 9:57 AM	File folder	
2023-04-19-10-17-24.bag	4/19/2023 10:21 AM	BAG File	407,549 KB
2023-04-19-10-17-24.log	4/19/2023 10:21 AM	Text Document	341 KB
2023-04-19-10-17-24.rotlog	4/19/2023 10:21 AM	ROTLOG File	298 KB
2023-04-19-10-17-24.rtk	4/19/2023 10:21 AM	RTK File	39 KB
cameratm.txt	4/19/2023 10:18 AM	Text Document	1 KB
cameraurl.txt	4/19/2023 10:18 AM	Text Document	1 KB
mission.json	4/19/2023 10:21 AM	JSON File	1 KB

Figure 7-11 .rtk file in sub-folder

In GNSS mode, select External Input and simply enter the .rtk file of the corresponding project in the External POS file field. Tap Next to complete the GNSS configuration.

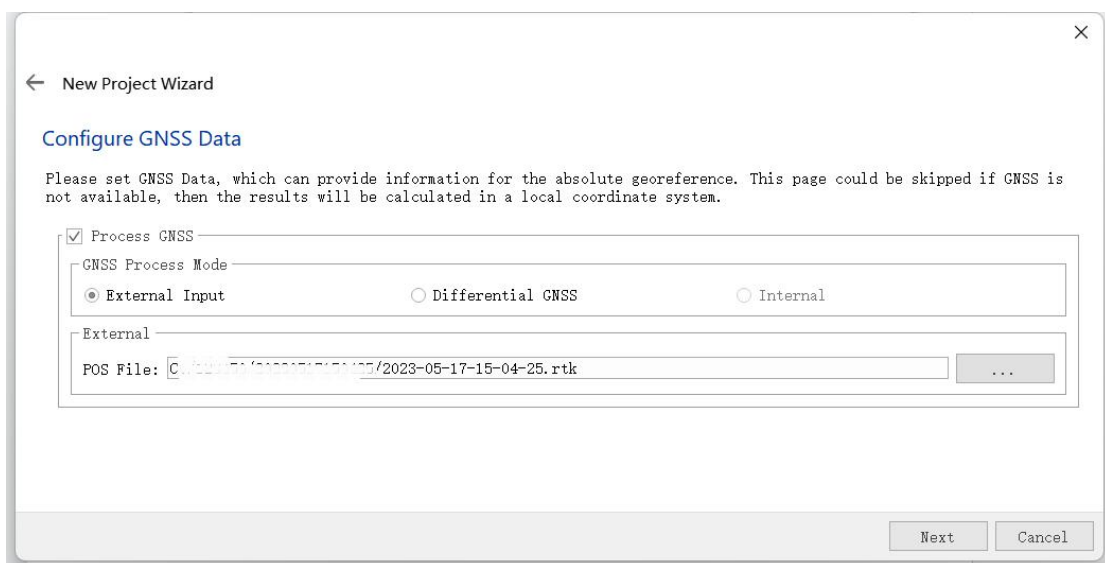

Figure 7-12 GNSS data configuration in RTK mode

7.2.3 Configuring Target Coordinate System

Select the target coordinate system required by the user (if no GNSS data is available, deselect "Target coordinate system").

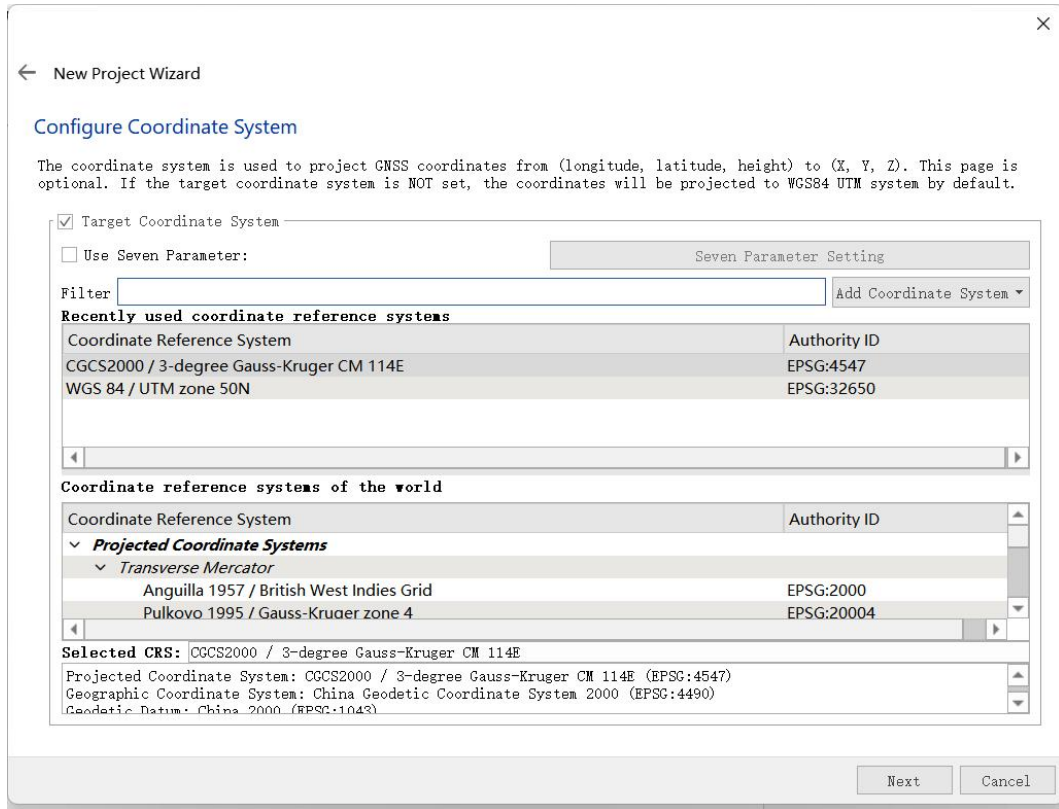



Figure 7-13 Configuring the output coordinate system

 **It is unnecessary to configure the target coordinate system when using the RTK mode for data processing. Since the target coordinate system has been set in advance when using RTK mode for data processing, the BP software can directly obtain the target coordinate system set during data collection.**

7.2.4 Configuring the Name and Project Path to Save Files

In the Configure project path interface, select the project name and path to save files (By default, the project name after creation is the name reading bag file. The custom project name is supported).

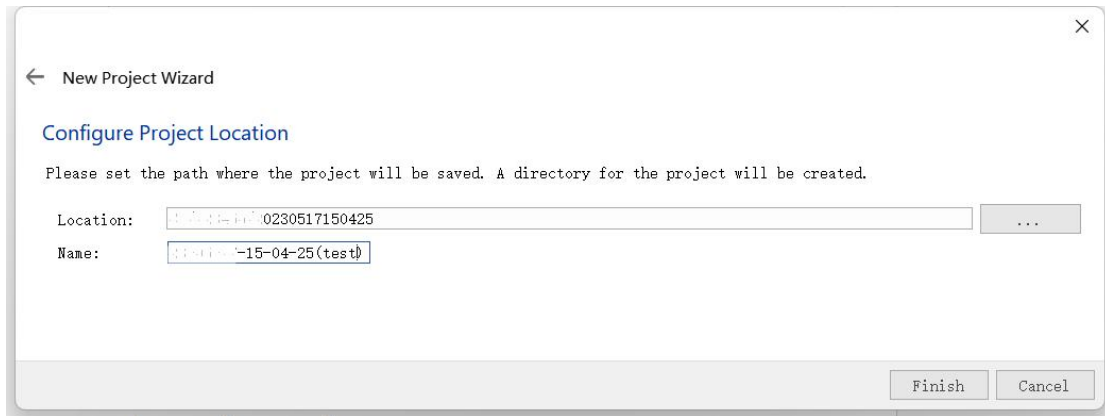

Figure 7-14 Configuring the Name and Project Path to Save Files

7.3 Running SLAM Program

In SLAM mode, select the generic mode. For other modes and more detailed settings, as well as the meaning of the parameter settings, see the BP instruction manual and the handheld FAQs.

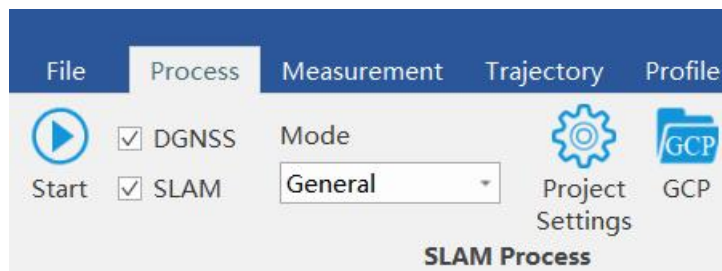

Figure 7-15 Mode selection

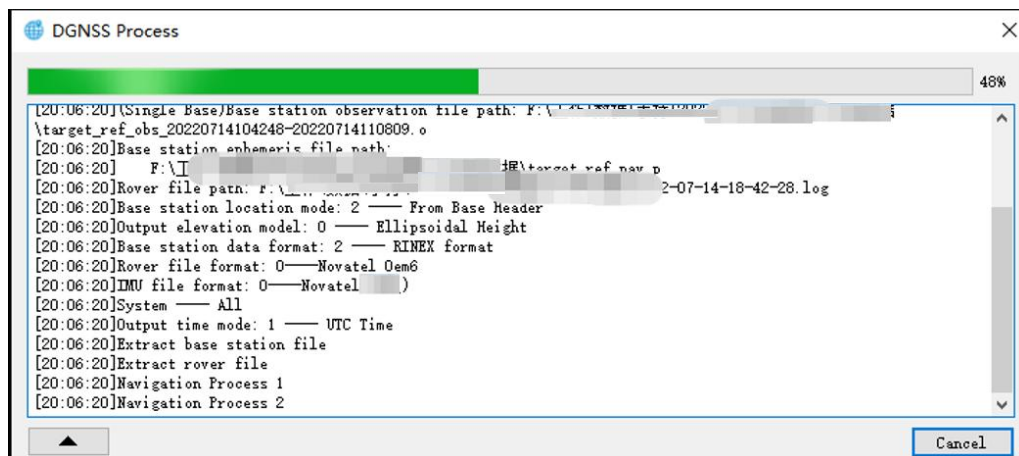

Figure 7-16 PPK processing (if GNSS data is available)

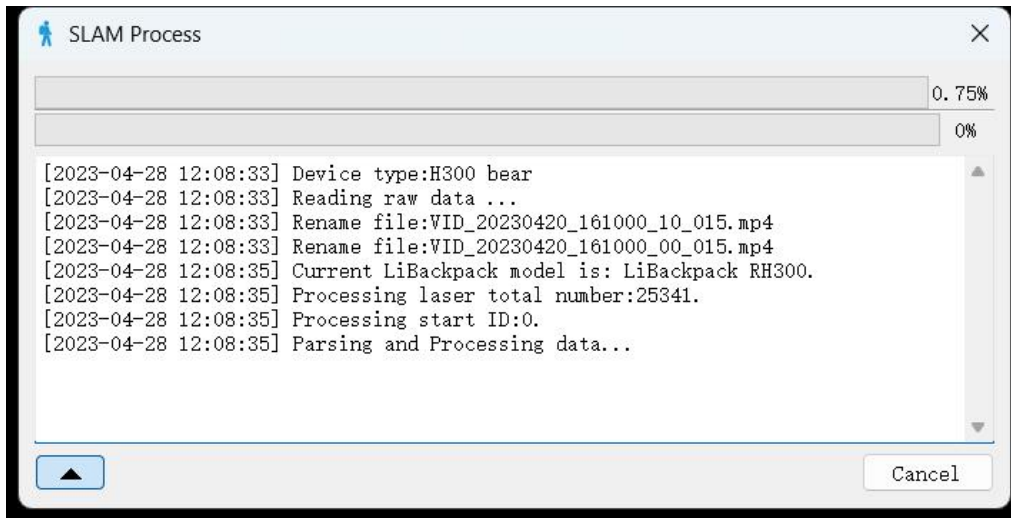

Figure 7-17 SLAM processing (the upper progress bar indicates the point cloud data processing, the lower progress bar indicates the video data processing)

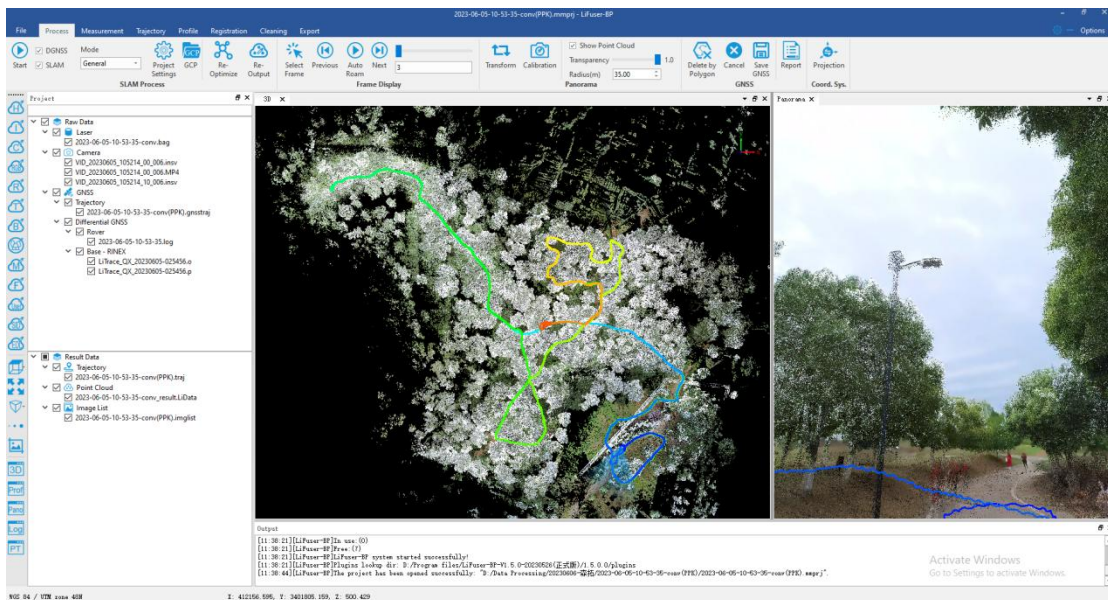

Figure 7-18 Data processing completed

After the data processing, you can view the point cloud data quality and point cloud coloring quality.

The LiFuser-BP software supports regular measurement operations (length, area, volume, and density) and track segmentation display. In addition, it supports point cloud profile operations, point cloud registration, point cloud data cleaning, and other regular operations. It provides full functions with powerful processing capability. Once the running is complete, check the data quality. For details, see [section 7.5](#)

7.4 GCP Adjustment

GCP adjustment, also known as SLAM optimization of GCP fusion, is based on field management + control point pairs, the data is adjusted and the absolute coordinates are given. Compared with the point cloud geographic coordinate correction, the **GCP adjustment** features higher accuracy. It is recommended currently, with better optimization.

7.4.1 Data Preparation

The data to be prepared for GCP adjustment includes:

- (1) LiDAR data for field GCP collection;
- (2) Images (if available);
- (3) Control point coordinate file (need to correspond to the laser control point position one by one).

Format of Control Point: name, X, Y, Z

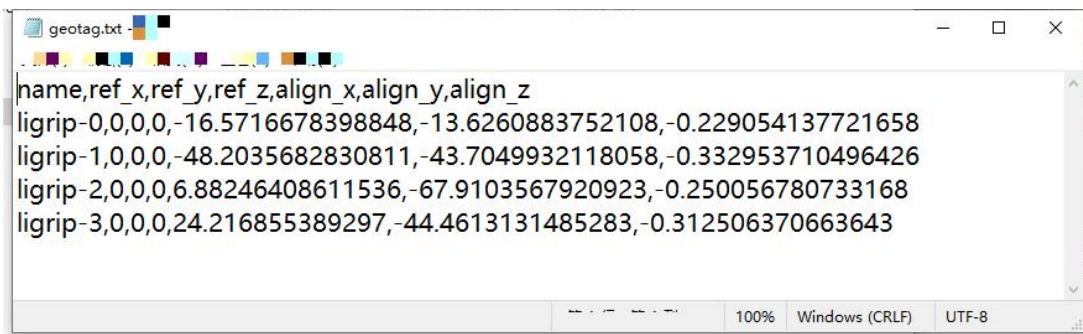

Figure 7-19 LIDAR data for the field GCP

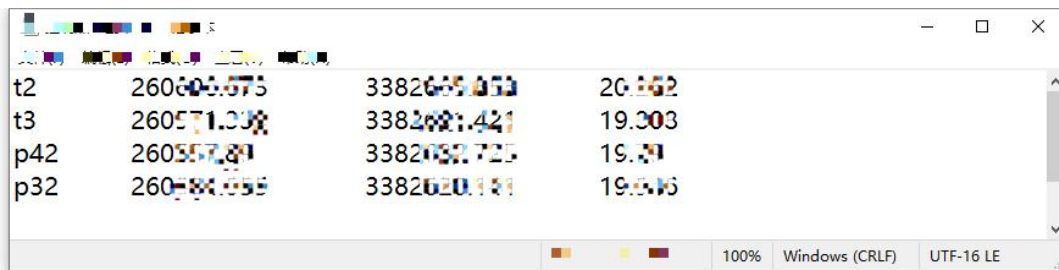

Figure 7-20 Control point coordinate file

7.4.2 SLAM processing -> GCP

In the SLAM processing interface, select the GCP button. The pairs interface appears.

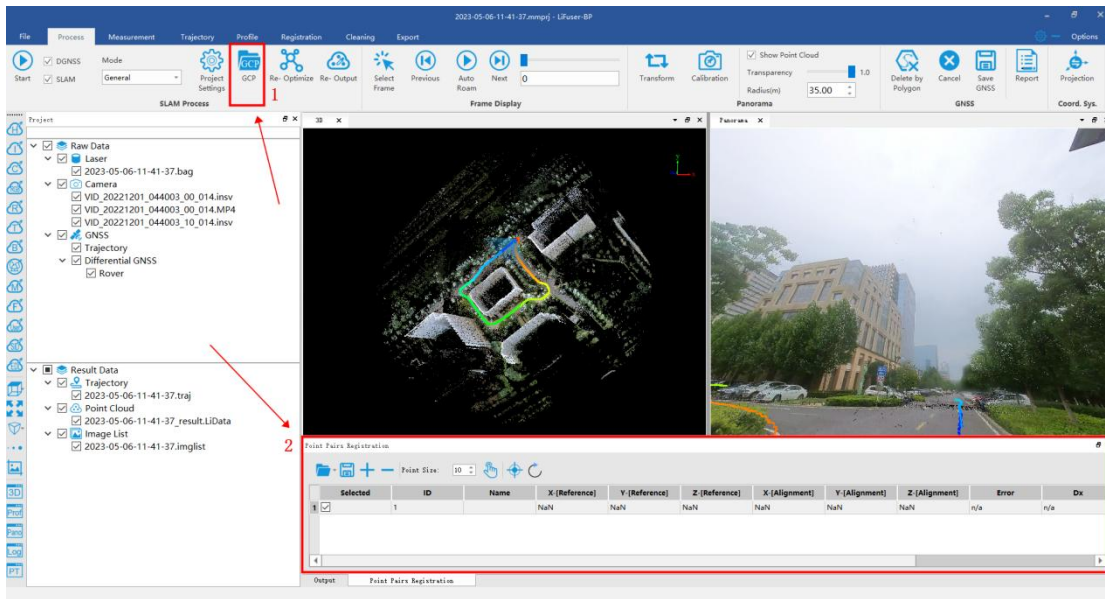

Figure 7-21 GCP adjustment

7.4.3 Loading the GCP Coordinate File (geotag.txt)

Choose SLAM processing -> GCP -> Load points, to load the geotag.txt file.

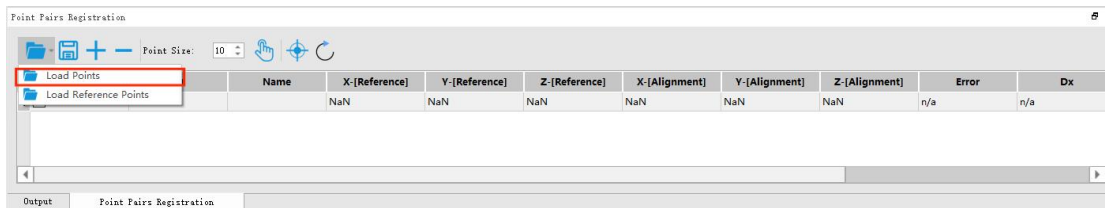

Figure 7-22 Adding geotag.txt

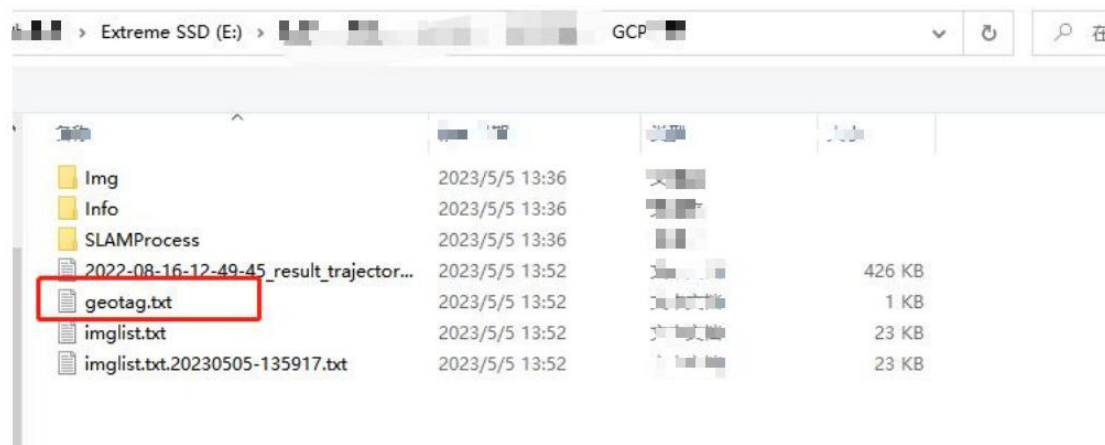

Figure 7-23 Opening geotag.txt in the folder

Set the properties corresponding to the different columns after loading the **geotag.txt** file.

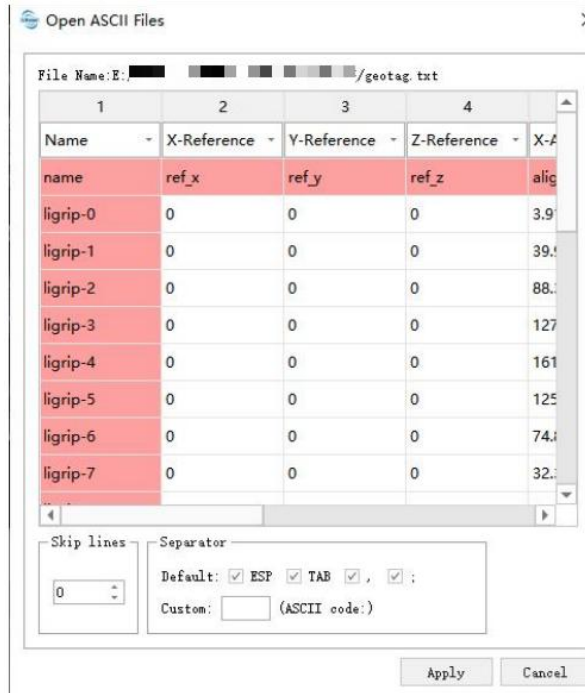

Figure 7-24 Loading geotag.txt

The software displays the field GCP location. You can check the validity.

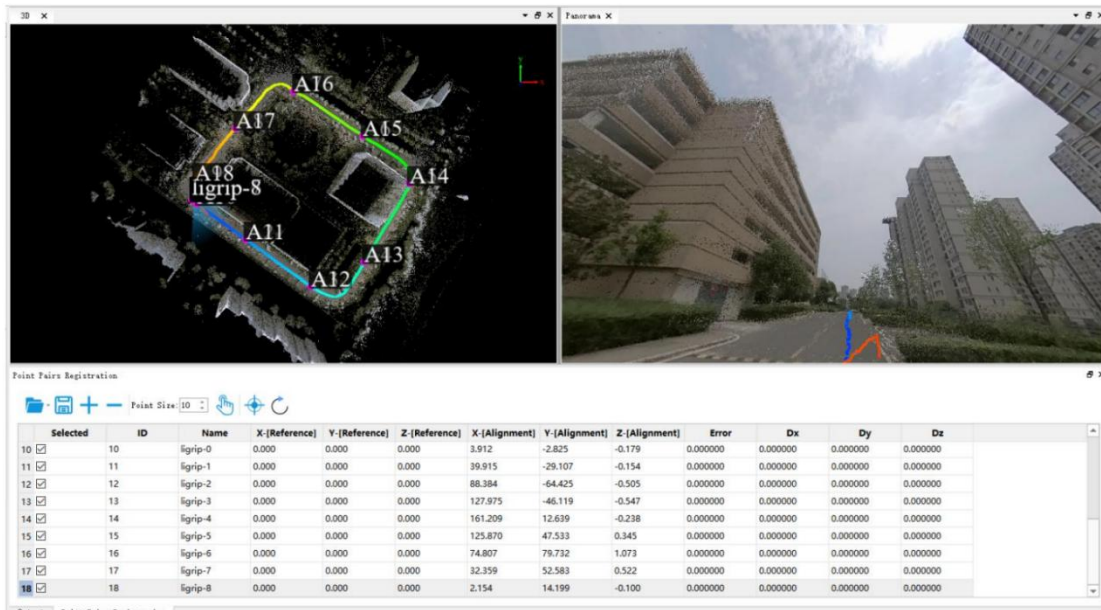

Figure 7-25 Software displaying the geotag .txt distribution area of the field GCP

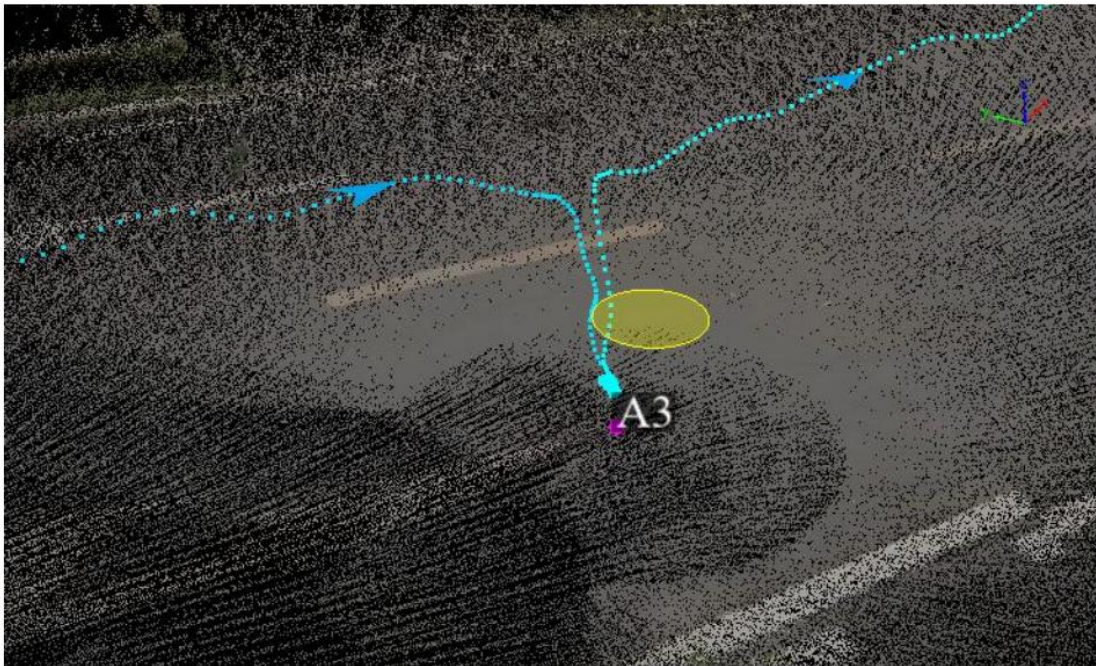

Figure 7-26 Checking field GCP

7.4.4 Importing the Coordinates of Control Points

Import control point coordinates. Supports the manual input and external input. The external import is mainly introduced. Click "Load Reference Points".

Format of control point: name, east coordinates, north coordinates, and elevation.

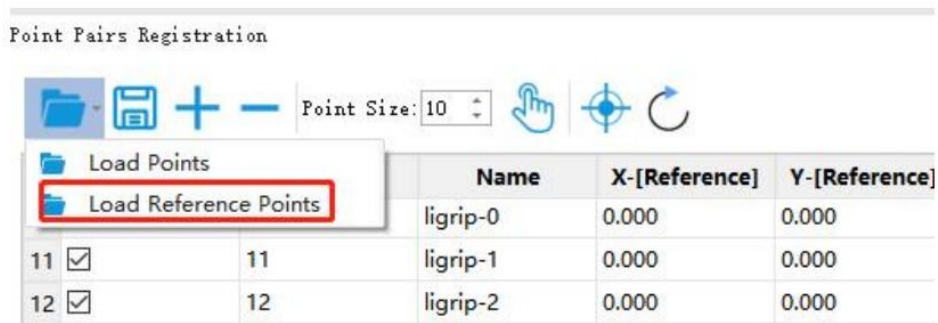

Figure 7-27 Loading reference point

In the pop-up prompt box, select Yes to open the control point file (TXT or CSV format). Select the corresponding column properties in the dialog box and click "Apply".

 **Note: X indicates east coordinate, and Y indicates north coordinate.**

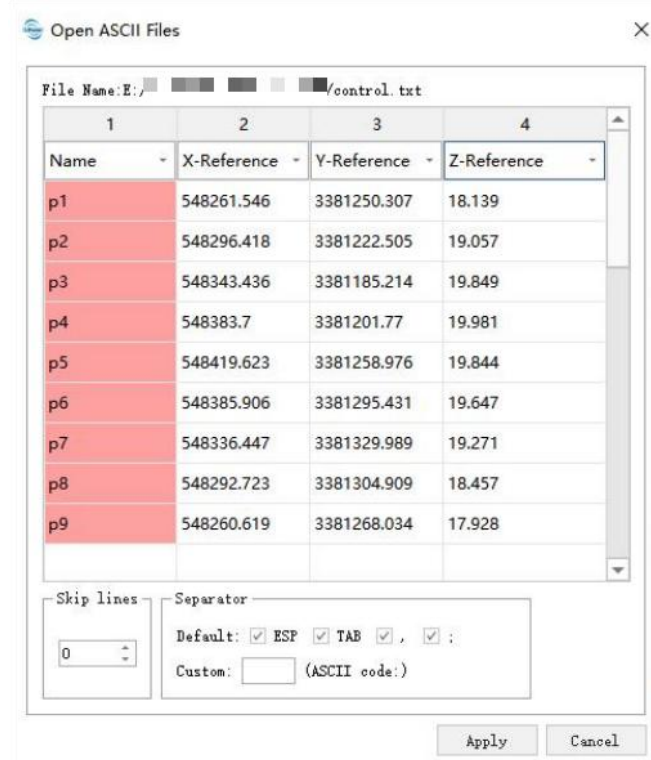



Figure 7-28 Load of reference points completed

After loading, the system will automatically calculate an error value, which represents the error between the control point and the GCP position before the adjustment. It is for reference only.

Point Pairs Registration



Selected	ID	Name	X [Reference]	Y [Reference]	Z [Reference]	X [Alignment]	Y [Alignment]	Z [Alignment]	Error	Dx	Dy	Dz
<input checked="" type="checkbox"/>	1	p1	548261.546	3381250.307	18.139	3.912	-2.825	-0.179	0.392661	-0.194628	-0.339972	-0.026862
<input checked="" type="checkbox"/>	2	p2	548296.418	3381222.505	19.057	39.915	-29.107	-0.154	0.270145	-0.086271	-0.253034	0.038854
<input checked="" type="checkbox"/>	3	p3	548343.436	3381185.214	19.849	88.384	-64.425	-0.505	0.153300	0.124078	-0.058047	0.068819
<input checked="" type="checkbox"/>	4	p4	548383.700	3381201.770	19.981	127.975	-46.119	-0.547	0.025753	0.005924	0.012670	-0.021624
<input checked="" type="checkbox"/>	5	p5	548419.623	3381258.976	19.844	161.209	12.639	-0.238	0.115717	0.054797	0.034065	-0.096059
<input checked="" type="checkbox"/>	6	p6	548385.906	3381295.431	19.647	125.870	47.533	0.345	0.081436	0.051508	0.019313	0.060048
<input checked="" type="checkbox"/>	7	p7	548336.447	3381329.989	19.271	74.807	79.732	1.073	0.172944	0.138869	0.083486	0.060459
<input checked="" type="checkbox"/>	8	p8	548292.723	3381304.909	18.457	32.359	52.583	0.522	0.206854	0.047258	0.200128	-0.022451
<input checked="" type="checkbox"/>	9	p9	548260.619	3381268.034	17.928	2.154	14.199	-0.100	0.338543	-0.141535	0.301390	-0.061183

Figure 7-29 Software automatically calculating the error of the control point and GCP position before adjustment

7.4.5 App GCP Transform

After loading the control points, click App GCP Transform , to perform GCP

adjustment.

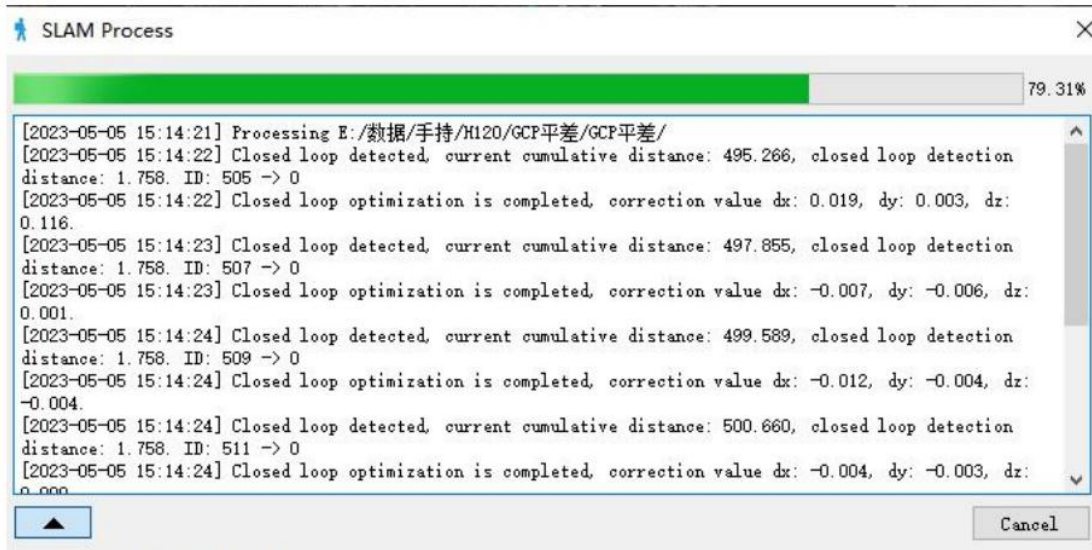

Figure 7-30 GCP adjustment

After the GCP adjustment is completed, the error of the control point becomes 0, and the point cloud has absolute coordinates.

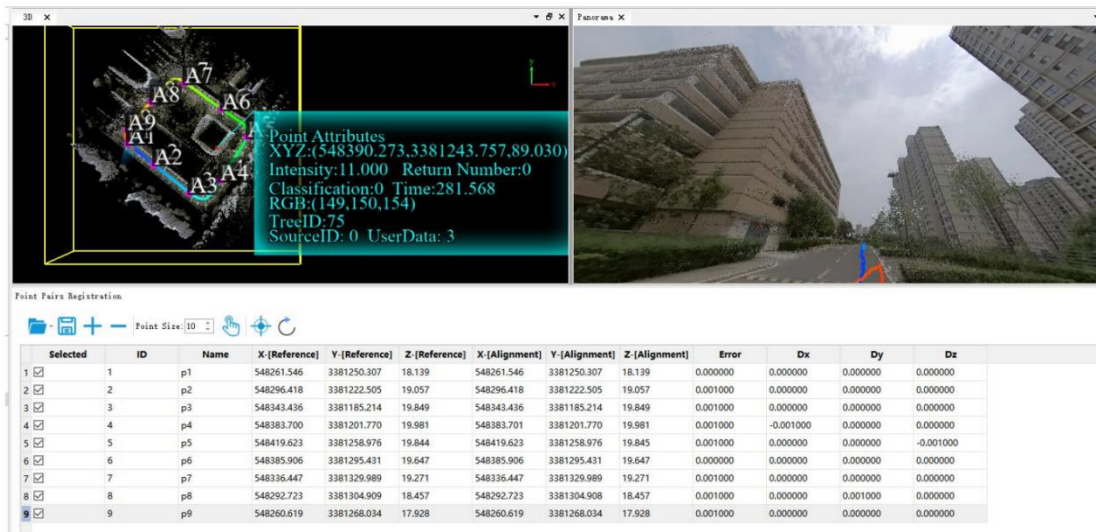



Figure 7-31 GCP adjustment result

If the adjustment is not satisfactory, or if the input is incorrect, you can use the GCP

restore function to return to the state before the adjustment. Click .

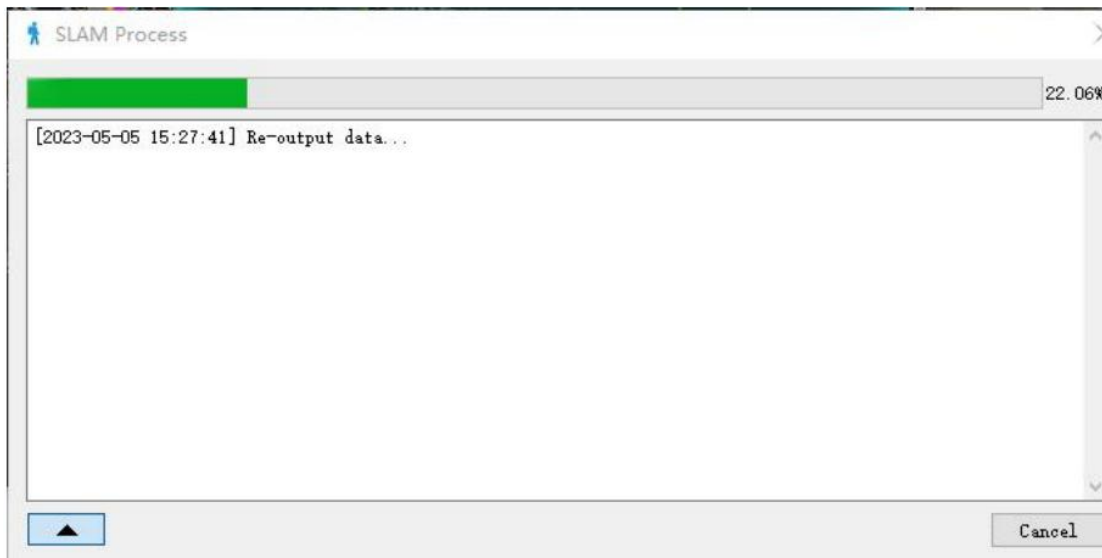

Figure 7-32 Software restore project

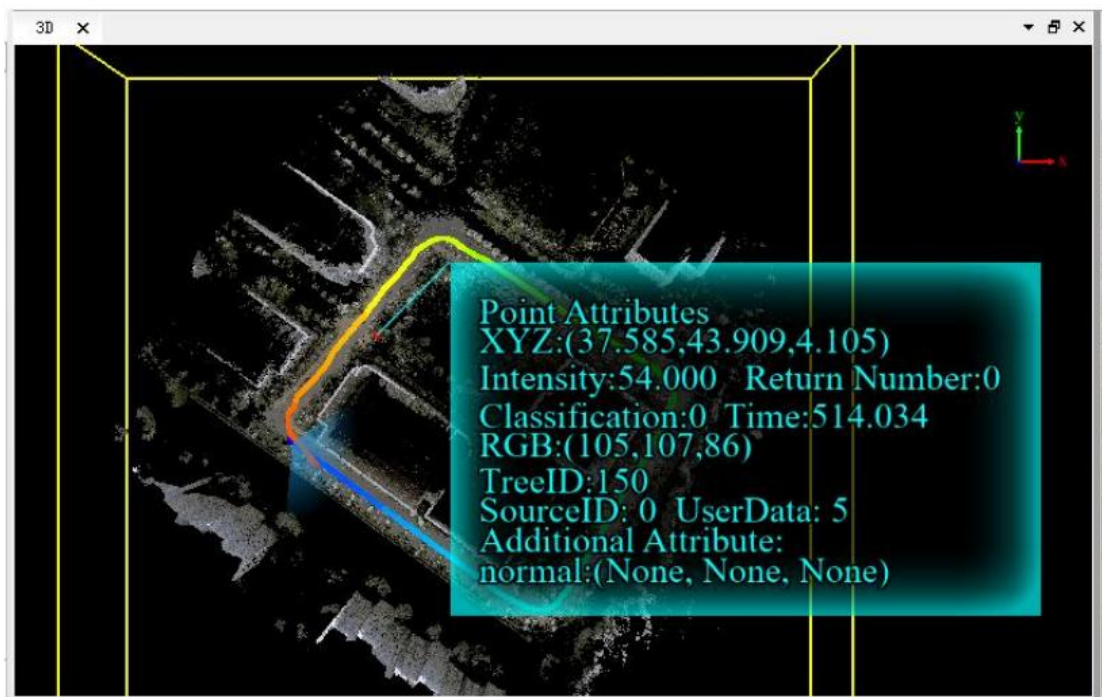



Figure 7-33 Software restoration project completed

 If the GCP adjustment is not satisfactory, or if the input is incorrect, you can use the GCP restore function to return to the state before the adjustment.

7.5 Data Quality Judgment

7.5.1 Viewing the Report

Choose **SLAM Process** -> **Report** to view the PPK processing report.



Figure 7-34 Viewing the report

If there are no field GNSS signals in indoor and mine scenarios, there is no PPK processing report.

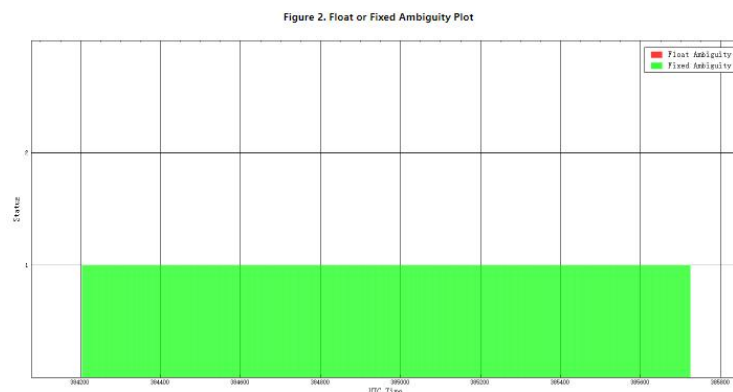
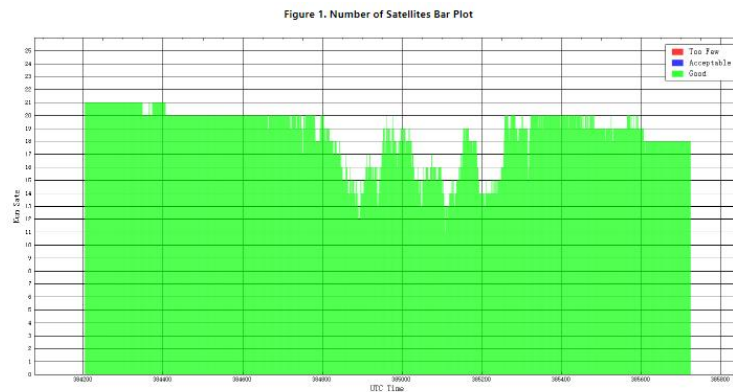

Figure 7-35 Viewing PPK quality report

7.5.2 Checking Closed Loop

If there is a closed-loop measurement, display  point cloud by time. Check the

layering phenomenon at the closed loop.

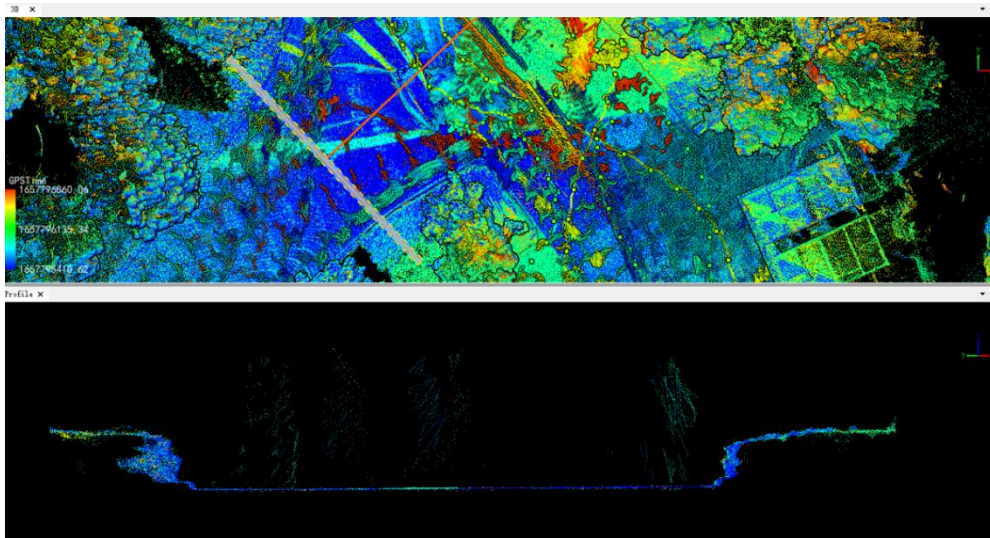

Figure 7-36 Checking the closed loop

7.5.3 Loading Checkpoints

Choose Registration -> Point pair to load the checkpoint.



Figure 7-37 Loading checkpoints

The checkpoint format should be the same as the control point format.

Set the properties corresponding to the columns.

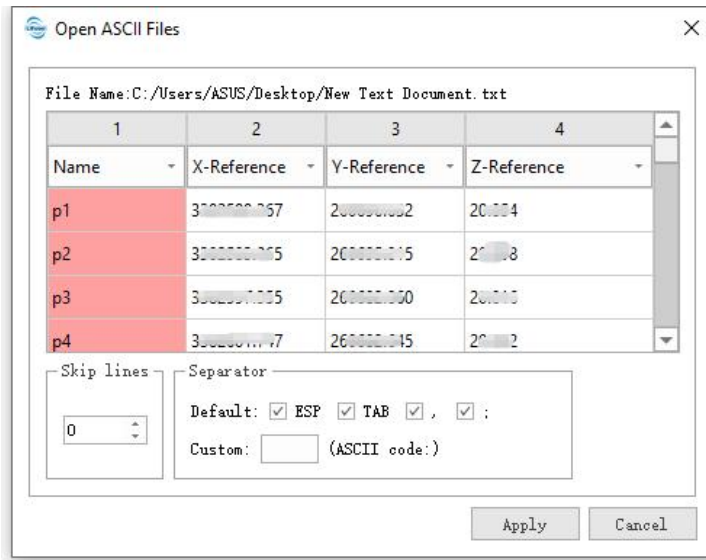

Figure 7-38 Setting the column properties

Check the differences between the checkpoints and the corresponding point cloud. See the marker line in the figure below.

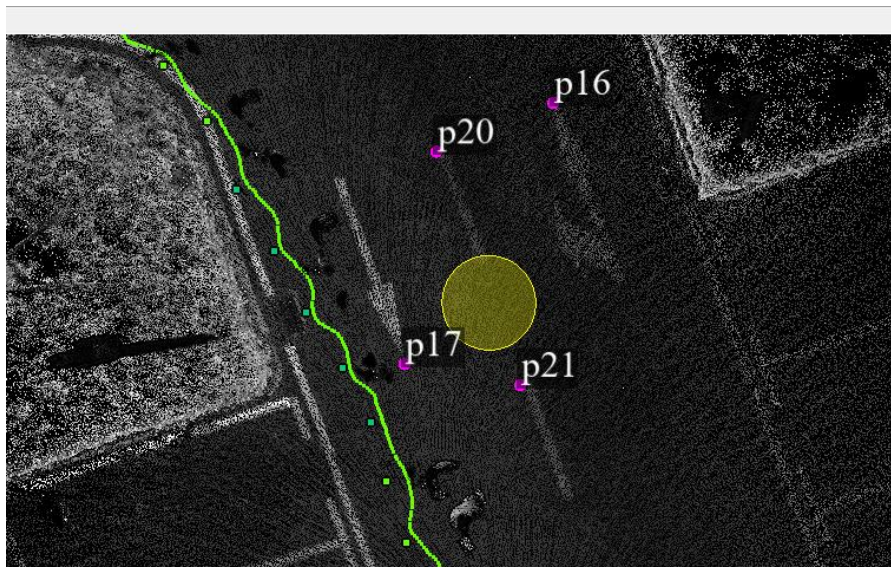

Figure 7-39 Checkpoint accuracy by visual inspection

To reflect the exact difference by a numerical value, choose Measurement -> Pick multi-point. Select the position of the corresponding checkpoint. Then add a column of properties in the list. Fill in the name of the point and save the 3D point.

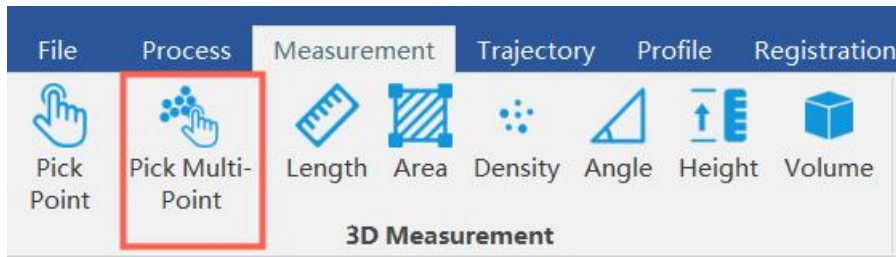

Figure 7-40 Multi-point selection

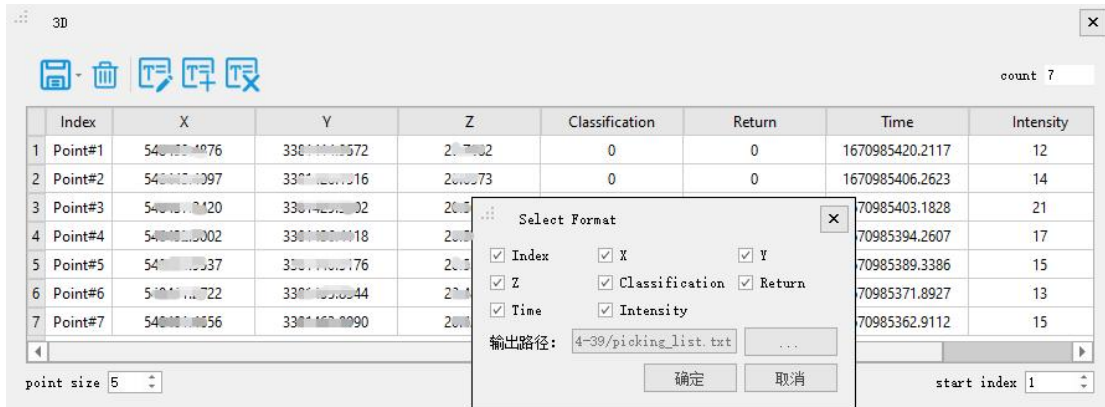

Figure 7-41 Saving points

As a result, there is the system output, with making statistics of errors.

CHAPTER

8

08 Multi-Project Merge

- Creating a new merge project
- Establishing link relation
- Point cloud optimization
- Quality assessment

The area to be surveyed cannot be measured in one go. Therefore, it is necessary to scan the area several times in order to obtain data in the entire survey area. Before merging multiple projects, you need to be aware of the following:

- ① The overlap rate of 10-20% between each project is guaranteed.
- ② There are relatively a large number of feature points in the overlapping area for merge.

8.1 Creating a New Merge Project

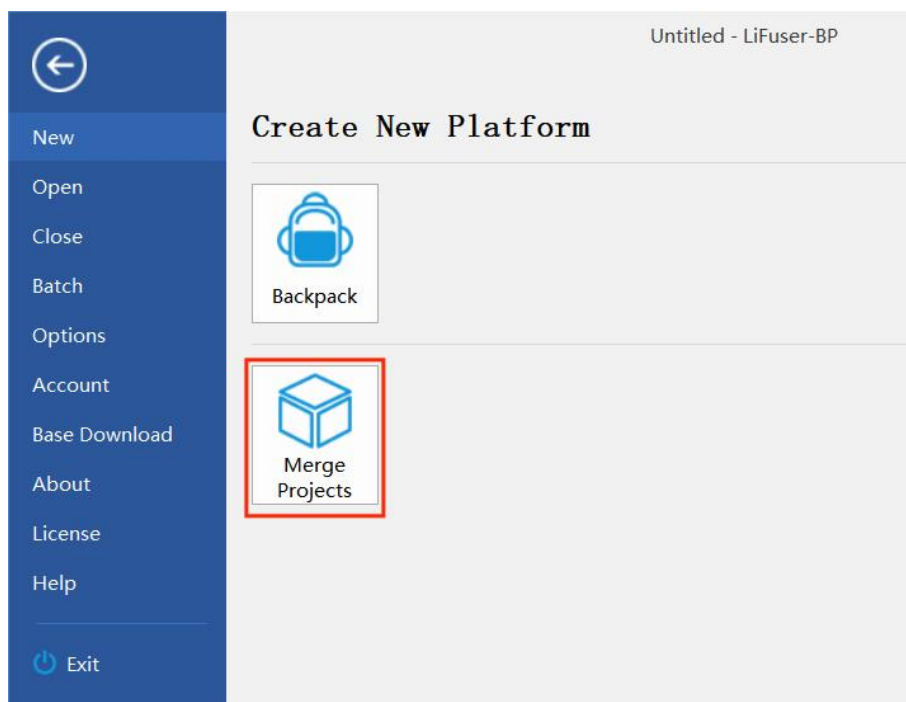

Figure 8-1 Creating a new merge project

Set the path for saving multiple projects.

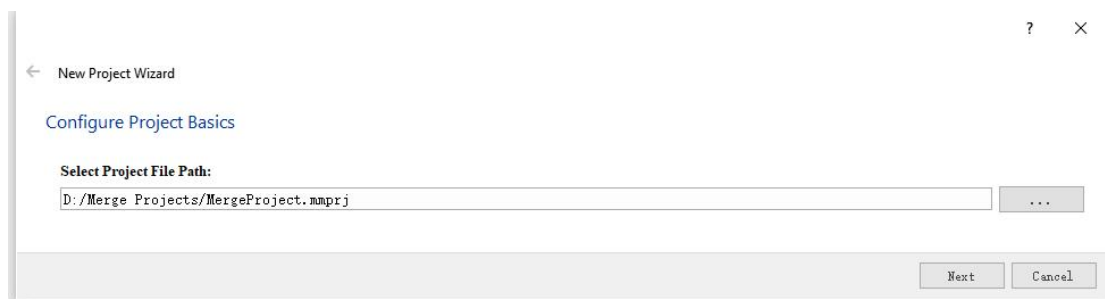

Figure 8-2 Setting the folder to save projects

Add a folder with the processing and a project folder after adjustment.

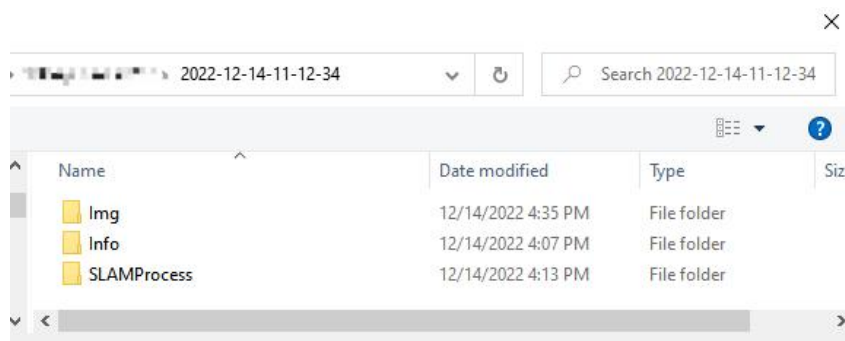
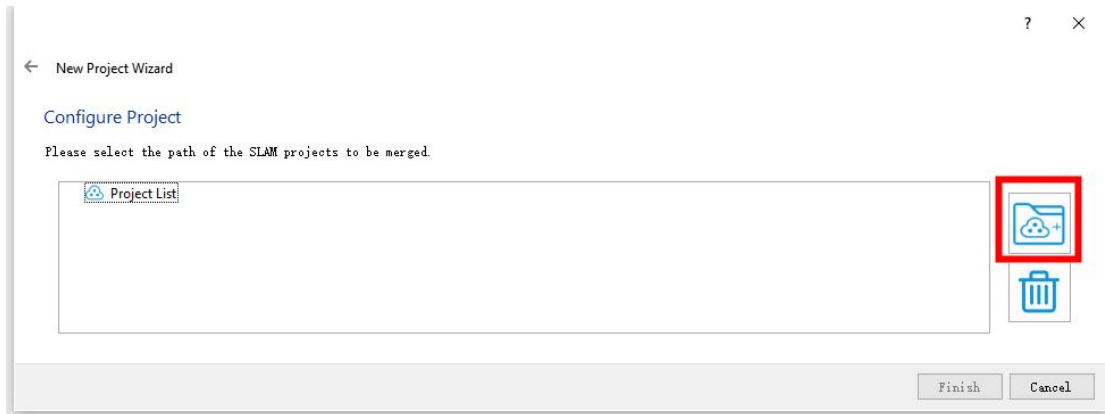

Figure 8-3 Adding the project to be merged



Figure 8-4 Finishing the creation

Click Finish.

8.2 Establishing Link Relation

8.2.1 Creating Link Relation with Absolute Coordinates

See the figure below. The Linked highlighting in red box indicates that the connected relation is empty. The Registration highlighting in blue box indicates data to be merged. We need to establish the inter-station link.

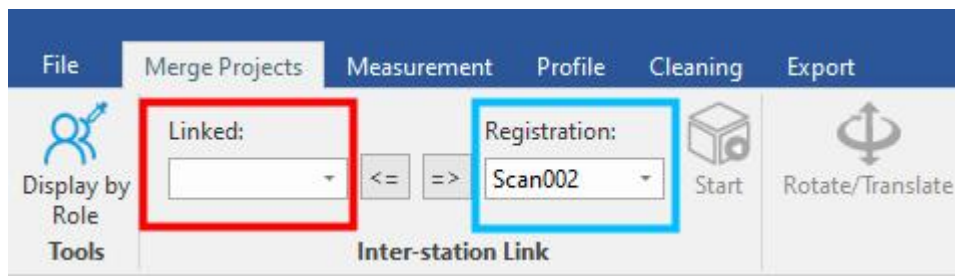

Figure 8-5 No connection is established

For example, link Scan 001 to Scan 002. Select Scan 001 from the Registration Window, then click the "<=" symbol to move Scan001 to Linked. Ensure that Scan 002 is selected in the Registration window.

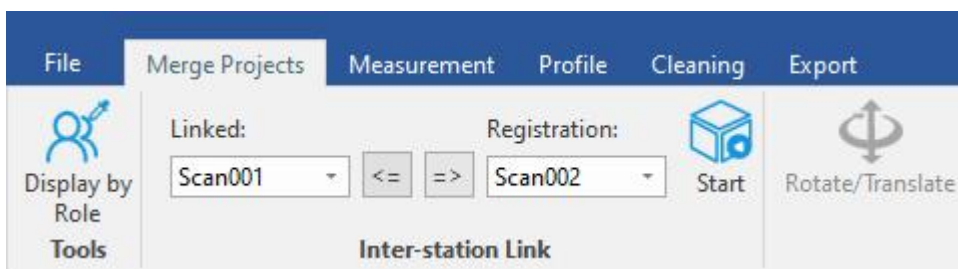
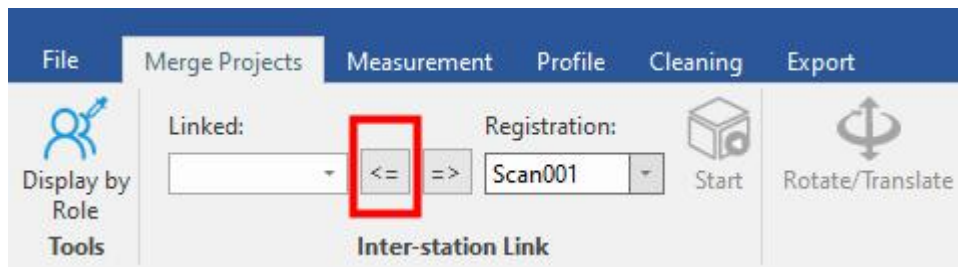

Figure 8-6 Establishing a link

Then click Start.

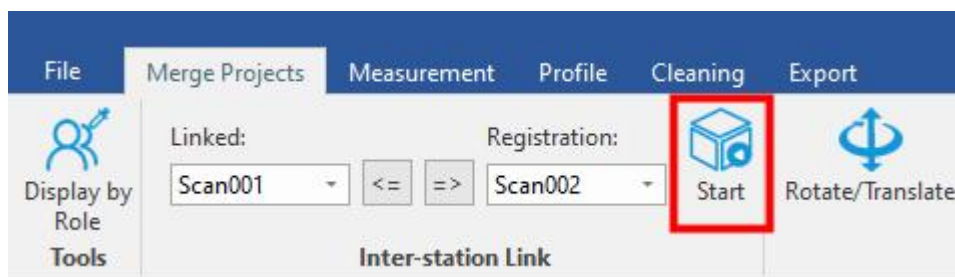

Figure 8-7 Start

The 3D view will now show a preview of the data to be merged together.

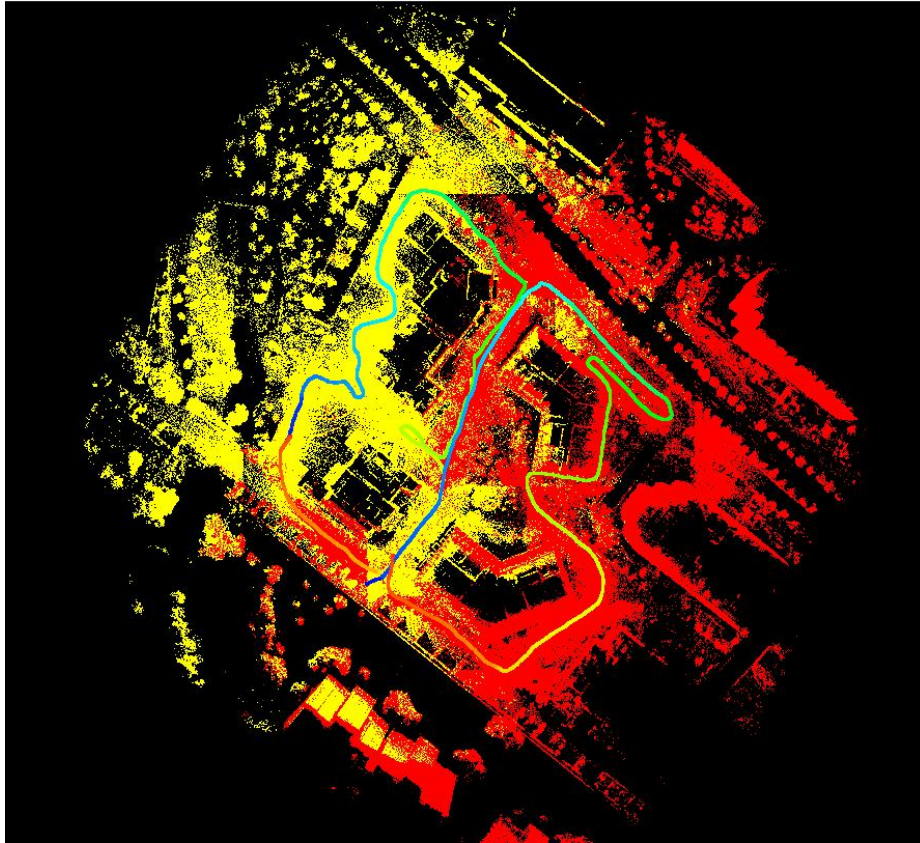

Figure 8-8 Preview of the point cloud

Finally, click the "<=" symbol to move Scan 002 to Linked.

At this time, Scan001 is linked to Scan 002. In the same method, all data can be moved to Linked.

8.2.2 Creating Link Relation with Relative Coordinates

The relative coordinate system is independent of the coordinate system (as shown in Figure 8-9). This is the difference between the relative coordinate system and absolute coordinate system. Therefore, you must rotate/translate for rough merge.

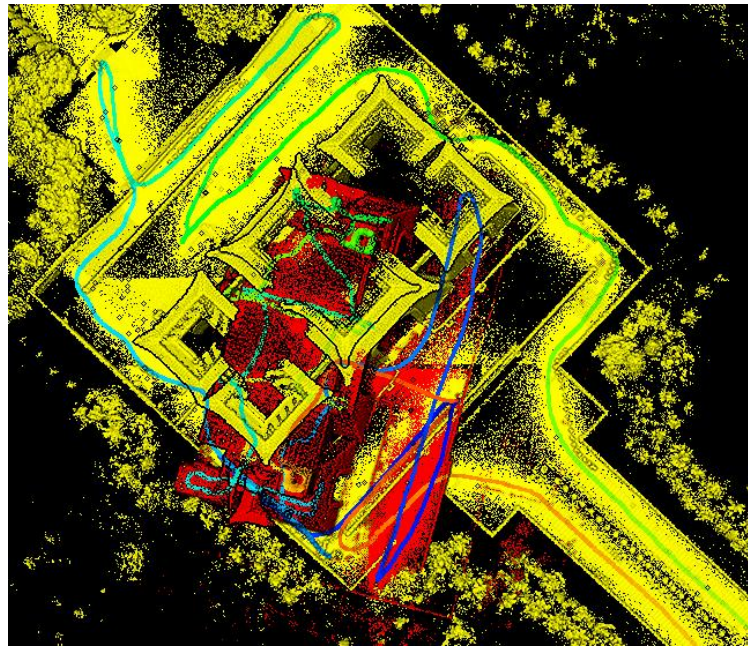

Figure 8-9 Disordered spatial relation of the relative coordinate system

The rough merge steps are as follows:

- ① Click Rotate/Translate.

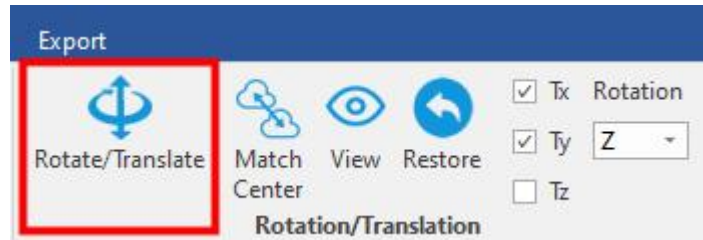

Figure 8-10 Choosing Rotate/Translate

- ② Adjust the direction of the translation and the axis of rotation

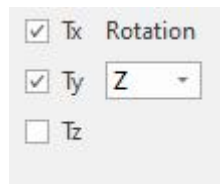

Figure 8-11 Setting up the rotate/translate

- ③ Rotate/translate until the point clouds are roughly merged. Click View to check whether they are merged.

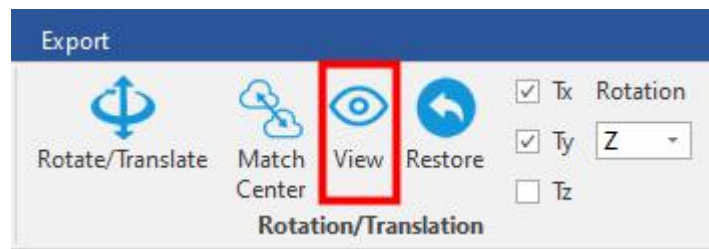

Figure 8-12 View

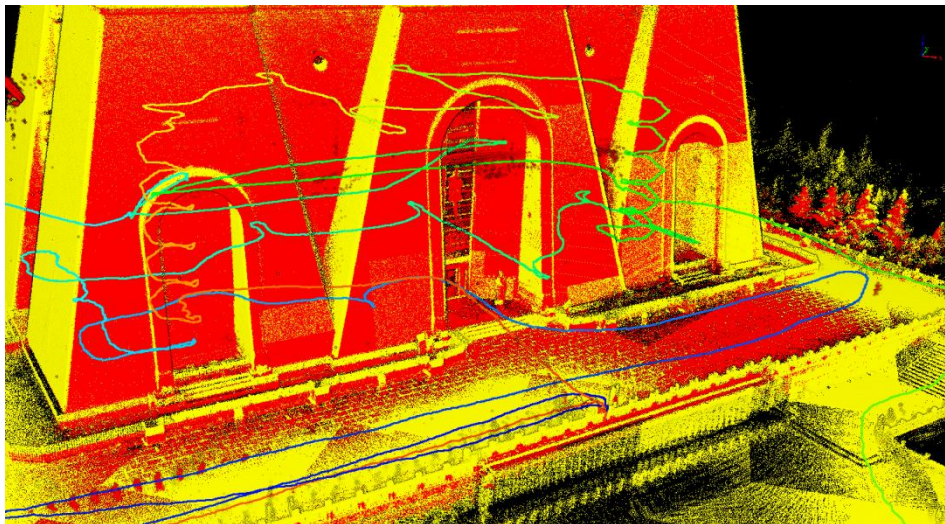

Figure 8-13 Clicking View to check the merge after rotating/translating

- ④ Click the matrix icon in the Transform area.

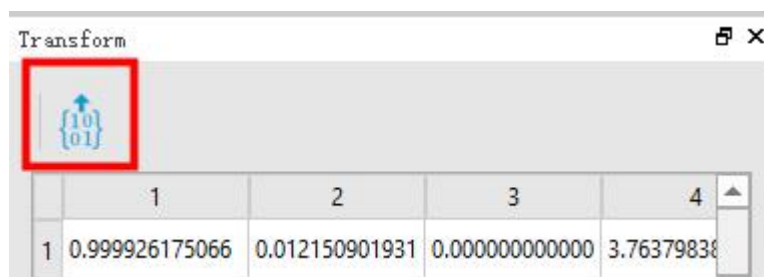

Figure 8-14 Applying the transform

Now, the two point clouds are linked.

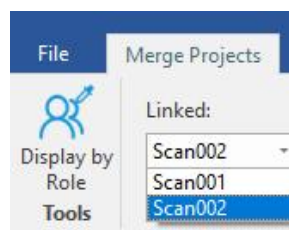

Figure 8-15 Linked relation

Create the links for the other point clouds in turn.

8.3 Point Cloud Stitching

Before the stitching, set up the project.

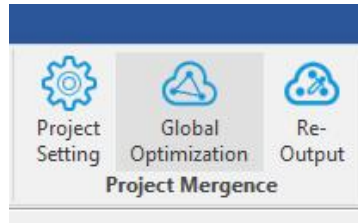

Figure 8-16 Project settings

For the details of parameters such as **Max Iterations**, **Fitness Score**, **Loop Distance**, and **Start/Finish closed-loop**, see BP instruction manual and FAQ documentation.

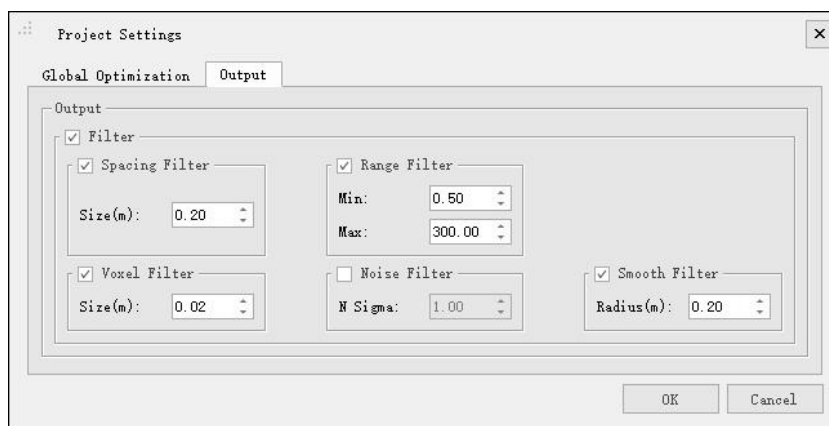
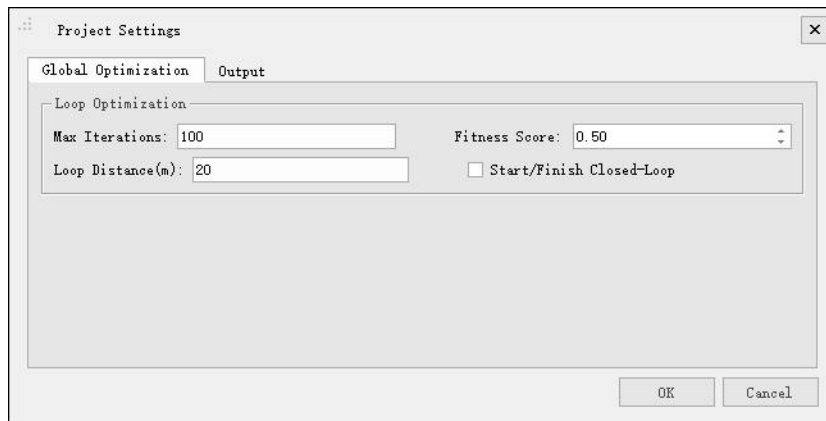

Figure 8-17 Project settings

Click the Option tab. Then, de-select the Filter check box (highlighted in the red box in Figure 8-18). Check the merge quality.

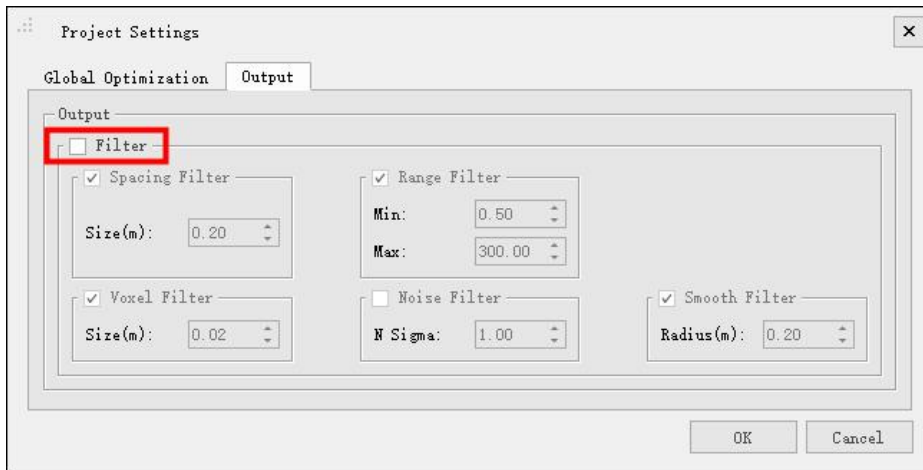

Figure 8-18 De-selecting the Filter check box

Click Global Optimization.

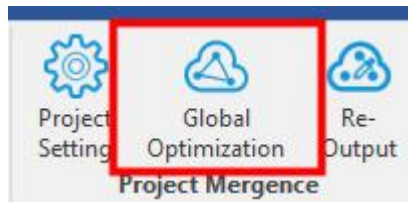

Figure 8-19 Global optimization

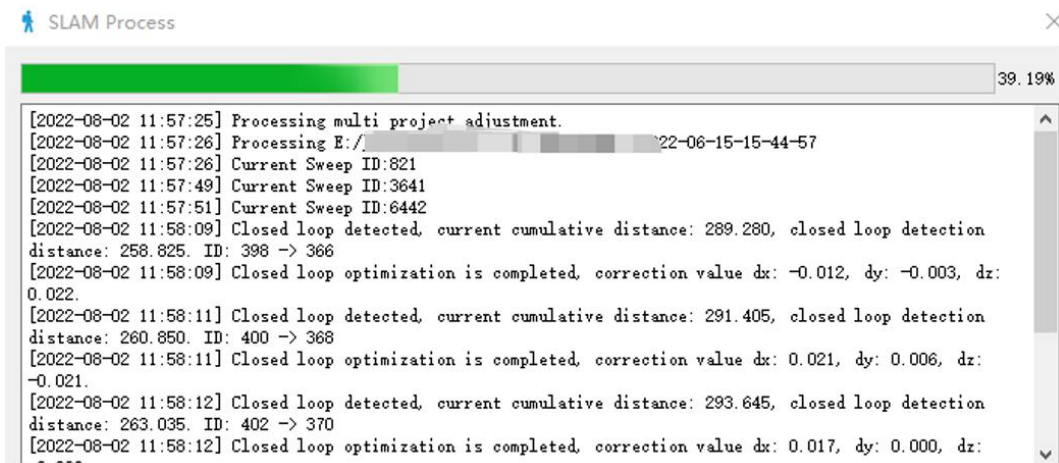

Figure 8-20 Global optimization in progress

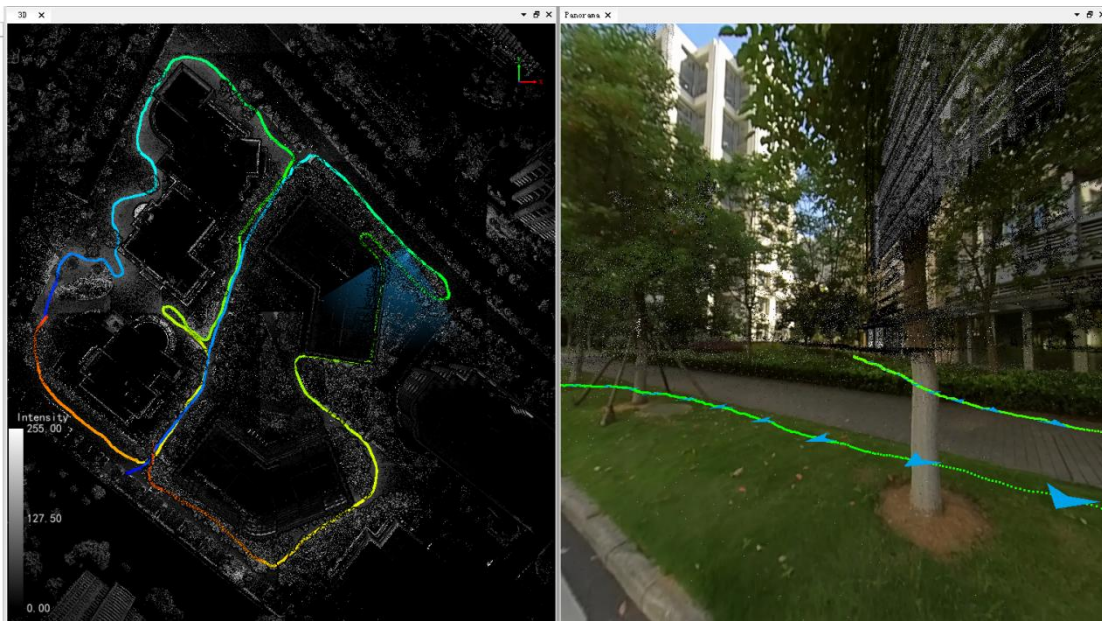

Figure 8-21 Merge completed

8.4 Quality Assessment

See the layering of point clouds. You can also view the layering of common areas between multiple measurements.

For other accuracy assessment, see "[7.5 Data Quality Judgment](#)".

8.5 Re-output

Choose Project Settings -> Output. On the Output tab, select the Filter check box. In this way, you can complete the re-output.

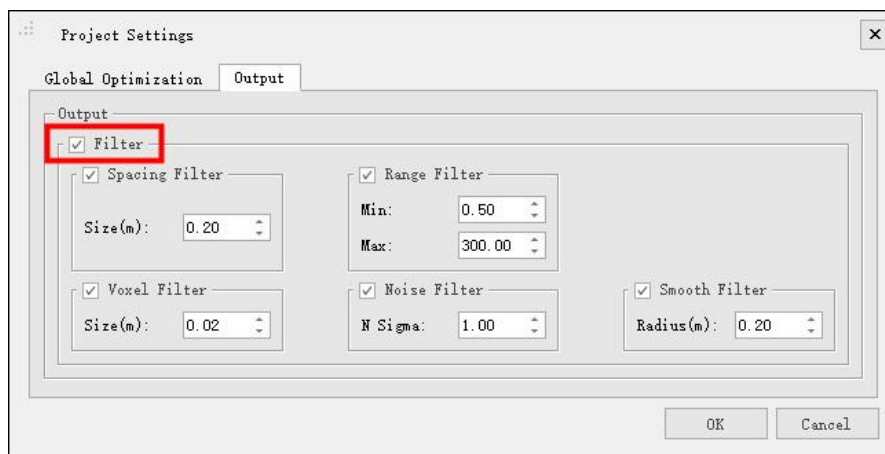

Figure 8-22 Re-output

CHAPTER

9

09 Maintenance and Upgrade

- Firmware upgrade
- Storage, transport, and maintenance

9.1 Firmware Upgrade

During the firmware upgrade, the electricity level should be at least 30%. The firmware upgrade supports three types: **online upgrade**, **offline upgrade** and **camera calibration parameter update**.

9.1.1 Online Upgrade

- (1) Ensure that your phone/tablet is able to connect to a 4G/5G networks or Internet via WiFi.
- (2) Power the device on and connect to the Internet via WiFi by using the GreenValley APP. All devices are displayed in green (except gnss and camera).
- (3) Return to the Home. Tap “Firmware Upgrade” and select “Online Upgrade”. Follow the software instructions and switch to 4G/5G networks or WiFi. Tap “Firmware Upgrade” again. The software will automatically download the firmware.

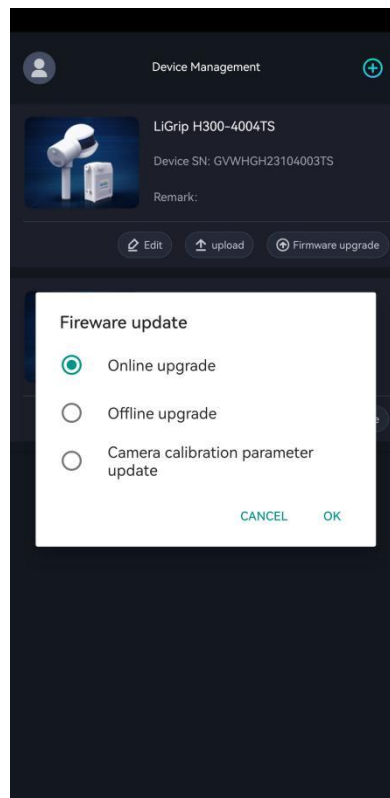

Figure 9-1 online upgrade

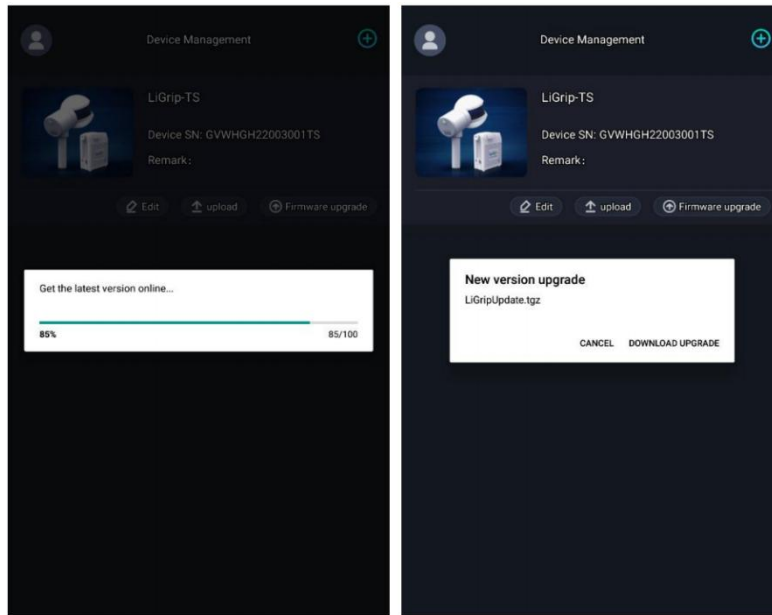

Figure 9-2 Download the latest firmware version online

- (4) After downloading, tap “Upgrade”. Follow the software prompts to switch networks. Connect to the device WiFi and return to the APP for firmware upload.

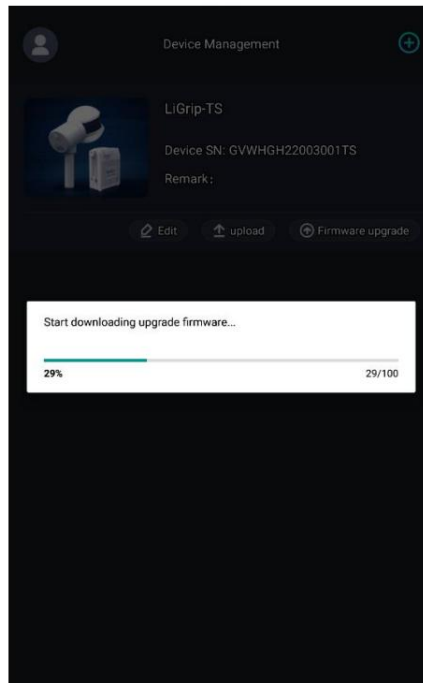

Figure 9-3 APP uploads the latest firmware version

- (5) When the upload is complete, the APP will prompt "Do you want to upgrade the firmware now". Tap “Yes”. The device firmware is upgraded.

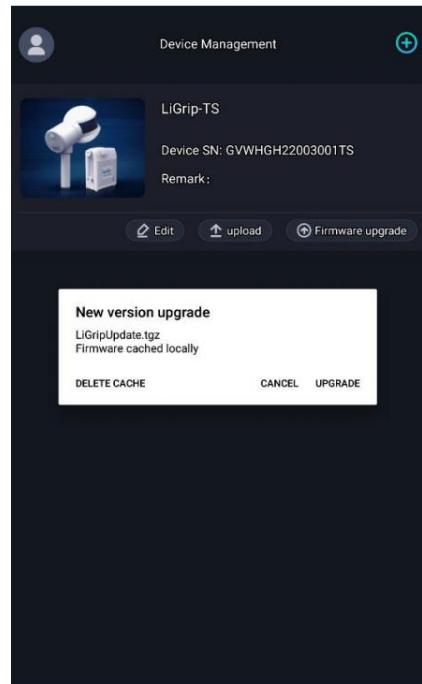

Figure 9-4 Upgrade the firmware version online

- (6) During the upgrade process, do not power off, after the upgrade is completed, wait 30s and then turn off the device, then turn on the device, the whole upgrade process is finished;

9.1.2 Offline Upgrade via USB Flash Drive

- (1) Obtain the latest firmware package from technical support website and move it in the root directory of the USB flash drive.
- (2) Power the device on and connect to the Internet via WiFi by using the GreenValley APP. All devices are displayed in green (except satellite and camera). **Note: Do not insert the USB flash drive before the device is turned on.**
- (3) On the device management interface, tap “Firmware Upgrade” and select “Offline Upgrade”. Follow the software prompts to upgrade the firmware.
- (4) During the upgrade process, do not power off, after the upgrade is completed, wait 30s and then turn off the device, then turn on the device, the whole upgrade process is finished;

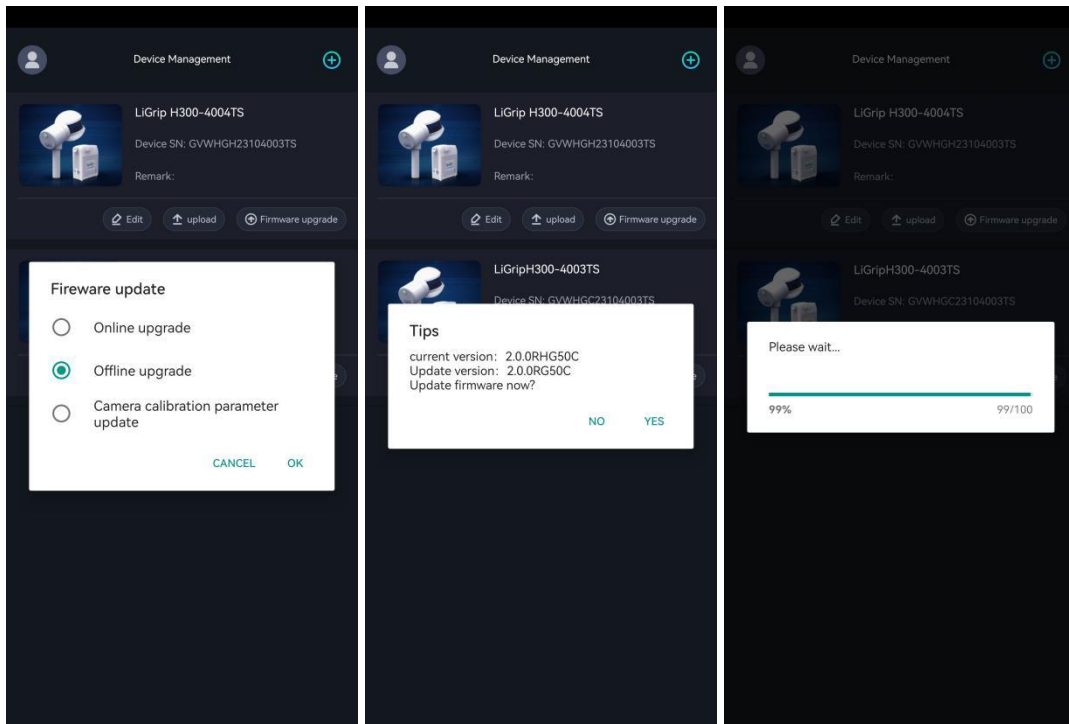

Figure 9-5 Upgrade the firmware version offline

9.1.3 Camera Calibration Parameter Upgrade

After completing the high-precision point cloud calculation, due to the placement error between the panoramic camera and the laser, there is a certain deviation between the panoramic image and the point cloud data, which cannot be perfectly superimposed. The camera calibration parameter upgrade refers to the use of LiFuser-BP's panoramic calibration module to calculate the placement error between the panoramic camera and the laser, thereby improving data deviation and improving accuracy.

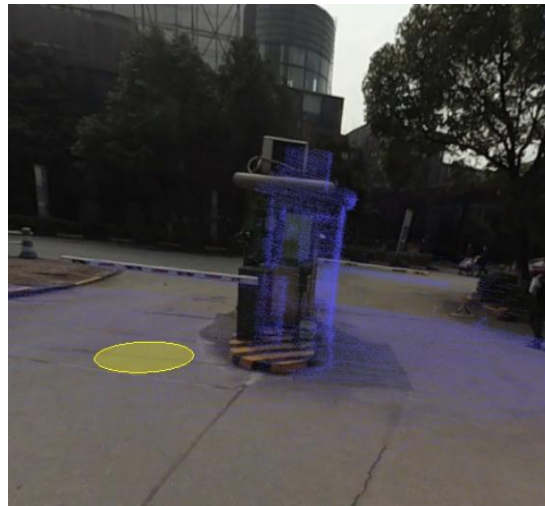



Figure 9-6 Panoramic camera and laser uncalibrated effect

The main steps of camera calibration are as follows:

(1) LiFuser-BP software click **Panorama -> Calibration** , and the calibration window pops up on the right side of the user interface;

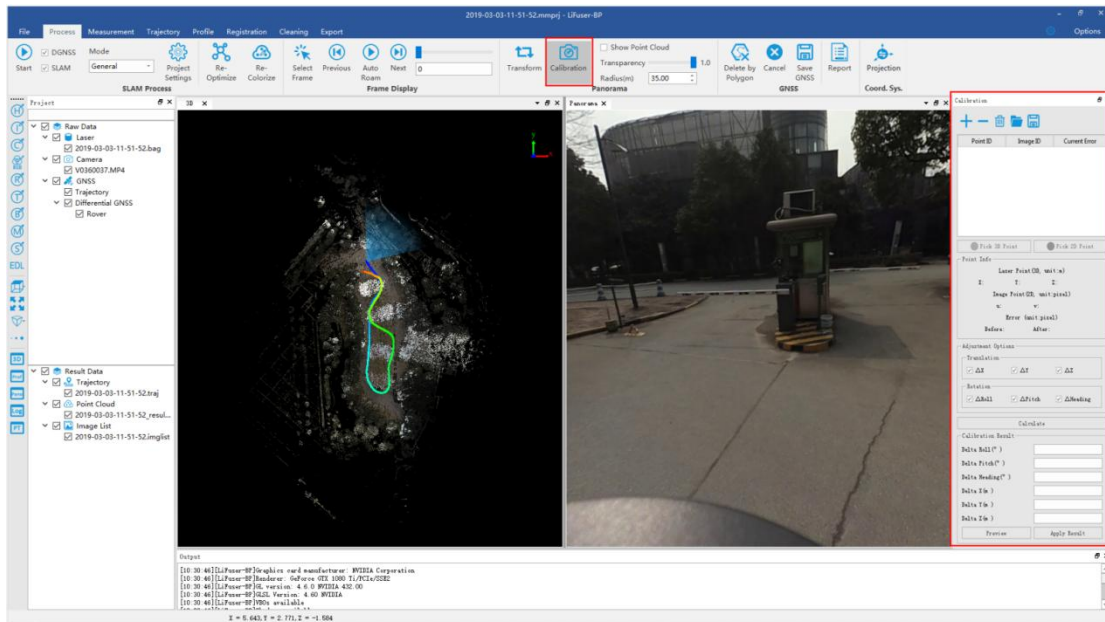

Figure 9-7 LiFuser-BP camera calibration

(2) **Add calibration points.** It is recommended to select camera exposure points in multiple directions of the scene, and then select multiple point pairs at the exposure points, and add at least 4 point pairs (for example, select 4 point pairs at the four exposure points of east, west, south, north, that is, at least 16 point pairs) .

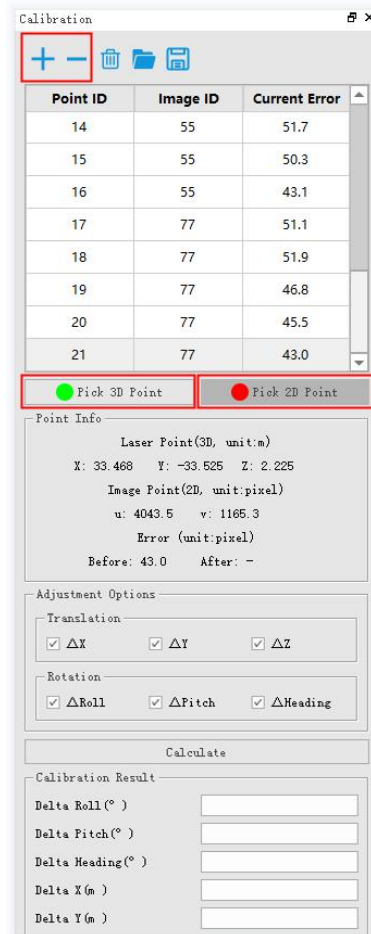

Figure 9-8 Add calibration points

(3) After the point pair is added, click Calculate to **calculate** the calibration parameters (the current error column can check the error size).

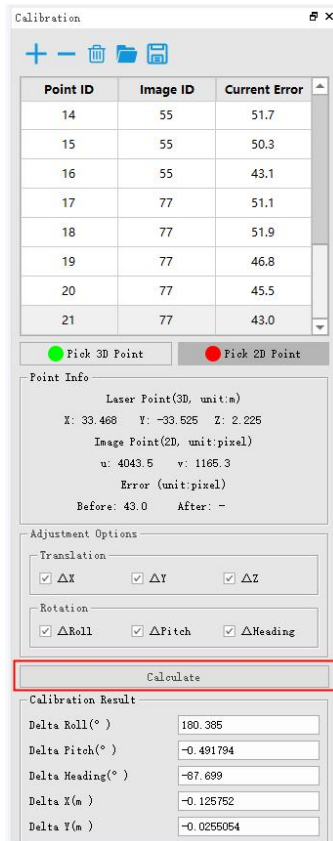
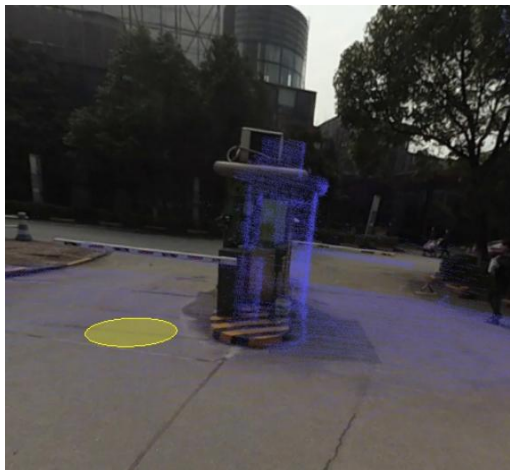
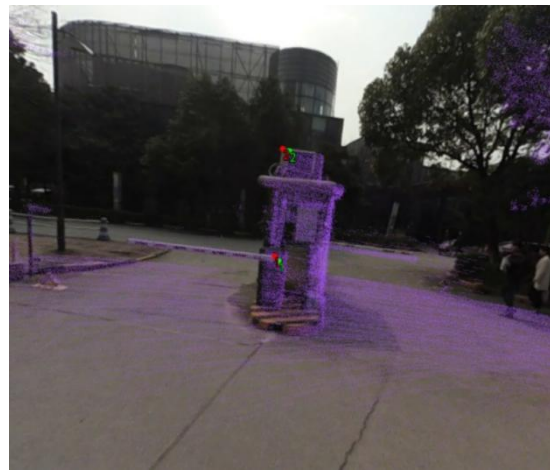

Figure 9-9 Calibration points calculation

(4) Click **Preview** to view the panoramic image and laser point cloud calibration results.



Before calibration



After calibration

Figure 9-10 Camera calibration result preview

(5) **Apply result.** Check whether the preview results meet the requirements, and if so, click the Apply button to apply the calculated calibration parameters to the data.

(6) Click the **Save** button  to save the calibration file **IMCAB.T** (**target project folder -> SLAMProcess -> temp**).

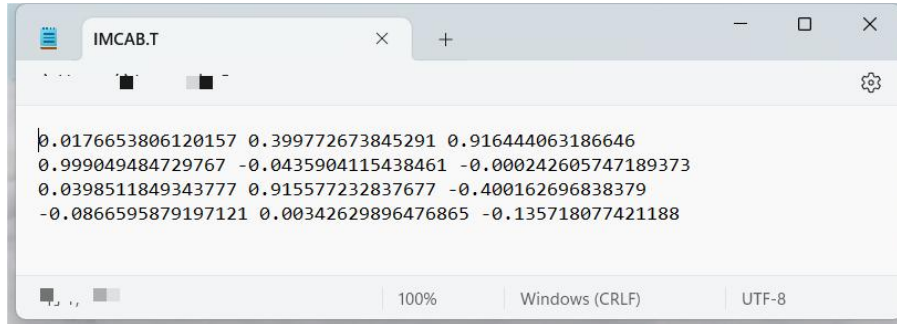

Figure 9-11 LiFuser-BP generates camera calibration parameter IMCAB.T file

(7) Make sure that the GreenValley APP is connected to the LiGrip device, and the **IMCAB.T** file is placed in the root directory of the U disk, and the U disk is inserted into the USB port of the LiGrip main box. At this time, you can select "Camera Calibration Parameter Upgrade" on the firmware upgrade interface of the GreenValley APP, and the device will detect the IMCAB.T in the U disk, and then upload it to the device host for automatic camera calibration parameter upgrade.

Note: For the specific operation process of camera calibration, please refer to the LiFuser-BP user manual.

9.2 Storage, Transport, and Maintenance

9.2.1 Storage

- ① The storage temperature range for the LiAir device is -20°C to 60°C. The storage environment should be well-ventilated, dry and dust-free.
- ② Before storage, ensure that all units are powered off. The device is stored in a special device box.
- ③ When the storage lasts for more than one month, the power-on test is required.

9.2.2 Transport

- ① The LiAir device should be transported in the packing box provided at the factory;

- ② If additional packaging is required in special circumstances, ensure that the box has a certain degree of resistance to pressure and that the box is labeled with signs such as "Precision Instrument", "Handle with care" and "Fragile" to avoid damage to the device.
- ③ This is a precision instrument. To protect the optical parts of the instrument from damage or misalignment, avoid excessive shock during transport or handling.

9.2.3 Maintenance

- ① Before switching on the device, make sure that the scanner window and camera are clean. Clean up immediately if they are dirty.
- ② After using the device, check the scanning window and camera. Clean them immediately if they are dirty.
- ③ Routine cleaning: Gently wipe the LIDAR scanning window and camera using special lens paper. Clean from the interior area to exterior area in a circular motion;

Appendix 1 Overview of SLAM

Simultaneous Localization and Mapping (SLAM) algorithms allow the vehicle to map out unknown environments. Engineers can use the SLAM to observe the position, attitude, and movement trajectory by sensors, so as to construct a map on the locations. During the movement, the vehicle is positioned the basis of location estimation and maps. That is, the real-time positioning and mapping construction work collaboratively.

Simply put, multi-frame point cloud data is collected during the movement, and the SLAM algorithm analyses and identifies the point cloud data frame by frame. When object A is scanned in the first two frames, the point cloud data of object A in both frames is analyzed to determine that it is the same object A. The data from the first two frames is merged. This is how the entire map is constructed frame by frame.

Therefore, if the identification ability of the SLAM algorithm is poor, and object A in the previous frame and object B in the next frame are determined to be the same object, they will be erroneously merged. The merged image does not represent the actual truth.

The prerequisite for the recognition is that there should be enough feature points in the environment. In an empty playground, it is not possible to merge two frames together, they can only be stacked here. The point cloud image becomes thicker, and the 3D image is not clear. As a result, the quality decreases.



According to this principle, the SLAM algorithm accumulates errors as the number of point cloud frames increases. The errors become larger and larger consequently. Suggestions: You should stop the project within 15 minutes if you need to attach color, or stop the project within 30 minutes if no camera is used. Then, start a new project to avoid the problems caused by the accumulation of errors.

Appendix 2 SLAM Applicable Environment

Operating temperature: -10° to 40°.

Waterproof and dustproof rating: IP54.

Applicable environment: As SLAM relies on features, it is suitable for areas with more distinctive features. Not suitable for scenarios with obscure features, open spaces, high traffic volumes, swaying foliage and flowers.

Non-applicable scenarios			
No.	Description	Scenario image	Remarks
1	Non-distinctive objects on the ground		Smooth tunnel
2	Open areas		Open areas, roads
3	Heavy traffic and large flow of people		Expressway, busy commercial streets with large flow of people, crossroads

4	Swaying trees and flowers		Parks and wooded areas in windy weather
---	---------------------------	--	---

Appendix 3 Troubleshooting-related Issues

1、 Initialization

- ① The laser should not face the areas with few features, for example, walls, ground, and sky.
- ② Do not initialize in locations with a high volume of pedestrian and vehicle traffic. Do not initializing at intersections.
- ③ Do not initialize in areas with dense weeds or shrubs.
- ④ When initializing in the dense vegetated areas, ensure that the site is wind-free.
- ⑤ When collecting data from the outside into scenarios such as tunnels and mines, initialize with facing the cave entrance.
- ⑥ When collecting data in a normal environment, initialize with the laser facing the collection scenario.
- ⑦ The initialization process of the device should be kept strictly stationary. It is recommended that the device should be placed on a stable surface and fixed with the aid of a hand, to avoid shaking of the device due to the rotational inertia of the laser.
- ⑧ The initialization time must be sufficient. When the indicator light changes from a fast flash to a slow flash, it signifies that the initialization is complete.
- ⑨ For the measurement of multiple stations, the initialization area should be within the previous measurement area. Ensure that there is a 10-20% of overlap in each measurement area.
- ⑩ Backpack kits, vehicle kits, or airborne kits should be stationary for initialization, with the movement in figure-8 trajectory.

2、 LiGrip Collection

- ① The data should be collected at a speed of not more than 1 m/s. The fast driving speed is not required.
- ② When collecting data in indoor scenarios, open the doors in advance. Do not move the door during the collection.
- ③ Plan the path in advance. Take a closed loop as much as possible if conditions permit.

- ④ The laser should always aim at the effective ground object.
- ⑤ Pass slowly in the confined space or move slowly in case of scenario switching.
- ⑥ In the collection of elevation information, it is recommended that the laser should face the elevation. You should operate when there are few moving targets. This can reduce data noise and errors.
- ⑦ When scanning multi-floor staircases, start by tilting the device back a little at each floor, scan the whole staircase and then lower the device to a normal angle before moving up.

3、 Vehicle-mounted Kit and Airborne Kit

The mapping principle of the H300 is still SLAM. Therefore, the application scenarios for the vehicle-mounted kit and airborne kit should have distinctive features. Accordingly, the vehicle-mounted kit or airborne kit is not applicable to scenarios with less distinctive features, for example, highway and large open area.

Both the vehicle-mounted kit and airborne kit need to start and end with a movement in figure-8 trajectory in an area with good satellite conditions (usually greater than 20 satellites).

Flight altitudes of around 50 m are recommended for airborne kit data collections. In addition, the attitude should not change too much during the flight. The rapid in-situ turns are not allowed.

The data collection via vehicle-mounted kit should not be greater than 40 km/h. Do not collect data in areas with too much traffic.

4、 RTK Mode

- ① The RTK supports only the NTRIP-compliant CORS networks.
- ② For RTK, the correct account and password are required in order to obtain the differential data.
- ③ For the RTK, it is not necessary to have a fixed solution in the whole process. In general, a fixed solution obtained within 50 m can provide a highly accurate point cloud.
- ④ For RTK fixed solutions, if a relatively large error is encountered, the collection can continue. The BP program will filter out the points with large errors.
- ⑤ Do not collect data in environments where there is strong electromagnetic

interference, such as electricity substations, high voltage power lines and iron pylons.

Appendix 4 Product Specifications

System Specifications	
Handheld device dimensions	195 mm (L) x 125 mm (W) x 350 mm (H)
Battery compartment size	134 mm (L) × 64.6mm (W) × 167mm (H)
Handheld device weight	1.67 kg (including GCP base and camera)
Voltage	15.2V
Battery capacity	5870mAh
Storage space	512GB
Protection class	IP54
Ports	USB, network port
Applicable environment	Indoor, outdoor, multi-scenario
Single battery operating time	3h
Continuous operation time per sortie	Max 55 min
Lidar parameters	
Scanning frequency	64W points/sec
Measuring distance	Up to 300 m
LiDAR Accuracy	Up to 1 cm
Scanning field of view	280° x 360°
Camera parameters	
Camera type	INSTA ONE RS 1-inch panoramic version
Photo resolution	6528x3264
Video resolution	6144x3072
Data format	MP4 INSV

CMOS size	1 inch
Camera size	95 mm (L) x 60 mm (W) x 55 mm (H) (including heat sink structure)
RTK Module*	
Satellite System	GPS+BDS+Glonass+Galileo+QZSS. Support 5 satellites and 16 frequencies
RTK accuracy	1 cm+1 ppm
RTK protocol	NTRIP protocol
Dimension	97 mm (L) * 71 mm (W) * 30 mm (H)
Weight	190g
GNSS raw data format	.log
RTK data format	.rtk
Compatible with	RTK supports H300 and H120
Mapping method	
Mapping principle	RTK-SLAM, PPK-SLAM, pure SLAM
Real-time solution	Support
Data results	
Relative accuracy	Up to 1 cm
Absolute accuracy	≤5 cm
Point cloud format	Las, LiData
*Purchased separately	