

MATRICE 350 RTK

User Manual

v1.0 2023.10

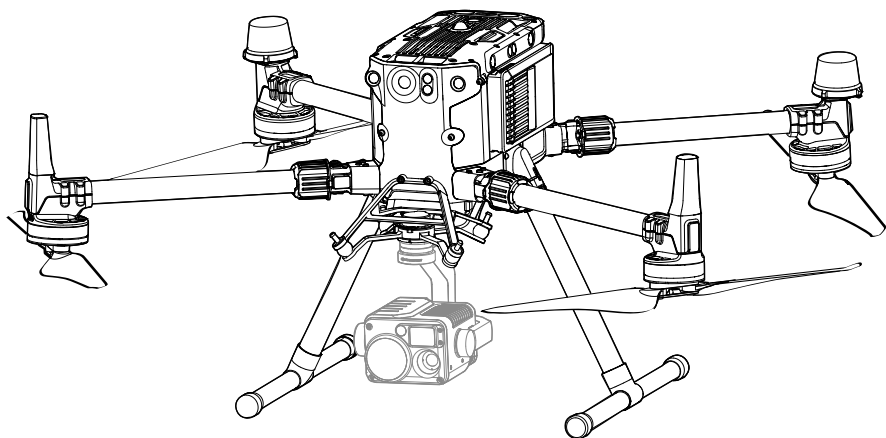



This document is copyrighted by DJI with all rights reserved. Unless otherwise authorized by DJI, you are not eligible to use or allow others to use the document or any part of the document by reproducing, transferring, or selling the document. Users should only refer to this document and the content thereof as instructions to operate DJI UAV. The document should not be used for other purposes.

Searching for Keywords

Search for keywords such as “battery” and “install” to find a topic. If you are using Adobe Acrobat Reader to read this document, press Ctrl+F on Windows or Command+F on Mac to begin a search.

Navigating to a Topic

View a complete list of topics in the table of contents. Click on a topic to navigate to that section.

Printing this Document

This document supports high resolution printing.

Using This Manual

Legends

 Important

 Hints and Tips

 Reference

Read Before Use

DJI™ provides users with tutorial videos and the following documents.

1. In the Box
2. Safety Guidelines
3. Quick Start Guide
4. BS65 Intelligent Battery Station User Guide
5. User Manual

It is recommended to watch all the tutorial videos and read the Disclaimer and Safety Guidelines before using for the first time. Prepare for your first flight by reviewing the quick start guide and refer to this manual for more information.

Downloading DJI Assistant 2 (Enterprise Series)

Download and install DJI ASSISTANT™ 2 (Enterprise Series) using the link below:
<https://enterprise.dji.com/matrice-350-rtk/downloads>

Tutorial Videos

Go to the address below or scan the QR code to watch the tutorial videos, which demonstrate how to use the product safely.



<https://enterprise.dji.com/matrice-350-rtk/video>

-
-  • The operating temperature of this product is -20° to 50° C. It does not meet the standard operating temperature for military grade application (-55° to 125° C), which is required to endure greater environmental variability. Operate the product appropriately and only for applications that it meets the operating temperature range requirements of that grade.
-

Contents

Using This Manual	3
Legends	3
Read Before Use	3
Downloading DJI Assistant 2 (Enterprise Series)	3
Tutorial Videos	3
Product Profile	10
Introduction	10
Feature Highlights	10
Preparing the Aircraft	11
Installing the Landing Gears	11
Unfolding the Aircraft	11
Mounting the Gimbal Camera	12
Mounting the Intelligent Flight Batteries	12
Flight Safety	14
Flight Environment Requirements	14
Wireless Communications Requirements	14
Operating the Aircraft Responsibly	15
Vision System and Infrared Sensing System	16
Detection Range	17
Calibration	18
Using the Vision System	18
Assisted Braking from Obstacle Sensing	19
Using Infrared Sensing System	19
Return to Home (RTH)	20
Smart RTH	20
Low Battery RTH	21
Failsafe RTH	23
Obstacle Sensing during RTH	23
Landing Protection	24
Center of Gravity Calibration	25
Flight Recorder	25
Flight Restrictions and Unlocking	25
GEO (Geospatial Environment Online) System	25
GEO Zones	25

Flight Restrictions in GEO Zones	26
Unlocking GEO Zones	28
Maximum Altitude & Distance Restrictions	29
Calibrating the Compass	30
Starting/Stopping the Motors	31
Flight Test	32
Post-Flight Checklist	32
DJI AirSense	32
Pre-Flight Checklist	33
Aircraft	36
Activating the Aircraft	36
Aircraft Overview	36
FPV Camera	37
Propellers	37
Using the Propellers	37
Replacing the Propeller Blades	38
Aircraft Indicators	38
Aircraft Beacons	39
Aircraft Auxiliary Lights	40
Gimbal Camera	40
Aircraft RTK	41
RTK Module Introduction	41
Enabling/Disabling RTK	41
DJI D-RTK 2 High Precision GNSS Mobile Station	41
Custom Network RTK	41
IP Rating	42
Expansion Ports	42
Remote Controller	44
Starting and Activating the Remote Controller	44
Powering On/Off	44
Activating the Remote Controller	44
Remote Controller Overview	45
Mounting the WB37 Intelligent Battery	47
Mounting the Strap and Bracket Kit	48
Adjusting the Antennas	48
IP Rating	49

User Interface	50
Home Screen	50
Screen Gestures	51
Shortcut Settings	51
Video Transmission	52
Remote Controller LEDs and Alert	53
Remote Controller LEDs	53
Remote Controller Alert	53
Charging the Remote Controller and Checking the Battery Level	54
Charging the Remote Controller	54
Checking the Battery Level	55
Linking the Remote Controller and Control Stick Modes	56
Linking the Remote Controller	56
Control Stick Mode	57
Buttons Overview	59
RTH Button	59
L1/L2/L3/R1/R2/R3 Buttons	59
Button Customization and Combinations	59
Flight Mode Switch	60
Calibrating the Compass	62
HDMI Settings	62
Advanced Dual Operator Mode	62
Intelligent Battery Station	66
Introduction	66
Warnings	66
Using the Battery Station	67
Specifications	69
Intelligent Flight Battery	71
Battery Features	71
Installing the Batteries	72
Using Paired Batteries	72
Powering On/Off	72
Checking Battery Level	73
Hot Battery Replacement	73
Warming the Battery	73
Battery Storage	74

Battery Maintenance	75
Capacity Calibration	75
Battery Maintenance	75
DJI Pilot 2 App	77
Homepage	77
Preflight Check View	80
FPV Camera View	81
Using FPV Camera View	81
Primary Flight Display (PFD)	82
Navigation Display	83
Top Bar	86
AR Projection	87
Gimbal Camera View	88
Using Gimbal Camera View	88
Wide Camera View	91
Thermal Camera View	91
Laser Rangefinder (RNG)	92
Smart Track	93
Map View	96
Annotation Management and Synchronization	97
PinPoint	97
Line and Area Annotation Management	100
Annotation Sharing	101
Mission Flight	101
Mission Flight Introduction	102
Mission Flight - Setting Waypoints	102
Mission Flight - Live Mission Recording	103
In-Flight Editing	105
Health Management System (HMS)	106
Intelligent Battery Station Management	107
DJI FlightHub 2	107
Firmware Update	109
Using DJI Pilot 2	109
Aircraft and Remote Controller Firmware Update	109
Battery Station and TB65 Batteries Firmware Update	109

Offline Update	110
Using DJI Assistant 2 (Enterprise Series)	110
Aircraft and Remote Controller Firmware Update	110
Zenmuse H20/H20T Firmware Update	110
Firmware Version Information	111
Appendix	113
Specifications	113
Using the Upward Gimbal Connector	117
Using the Dual Gimbal Connector	117
Using the CSM Radar	119
Extended Screw Holes Description	121
Troubleshooting Procedures	122
Risk and Warnings	122
Disposal	122
C3 Certification	123
MTOM Statement	123
Direct Remote ID	123
List of Items, including Qualified Accessories	124
List of Spare and Replacement Parts	124
Remote Controller Warnings	124
GEO Awareness	125
EASA Notice	128
FAR Remote ID Compliance Information	128
After-Sales Information	128

Product Profile

This chapter introduces the major features of the product.

Product Profile

Introduction

The DJI MATRICE™ 350 RTK (M350 RTK) is a powerful industrial aircraft platform that features an advanced flight control system, six directional sensing and positioning systems, and a night-vision FPV camera. The M350 RTK supports DJI CSM Radar and is compatible with DJI DGC2.0 connector gimbals, up to three independent gimbals, and several SDK expansion ports. The safety beacons on both the top and the bottom of the aircraft allow the aircraft to be identified at night or in low-light conditions. The auxiliary lights help the vision positioning system achieve better performance at night or in low-light conditions. The flight time of M350 RTK is up to 55 minutes ^[1] without a payload with the new TB65 dual-battery system. High accuracy Surveying and Mapping is available when used with the DJI ZENMUSE™ L1/L2/P1. AI Spot-Check and PinPoint can be used with the DJI Zenmuse H20 series.

The DJI RC Plus remote controller features O3 Enterprise, the latest version of DJI's signature OCUSYNC™ video transmission technology, and can transmit a live HD view from the camera of an aircraft to display on the touchscreen. The remote controller has a 7.02-inch high-brightness 1200 cd/m² touchscreen with a resolution of 1920×1200 pixels. The Android operating system comes with a variety of functions such as GNSS, Wi-Fi, and Bluetooth. The remote controller comes with a wide range of function buttons as well as customizable buttons, which can easily control the aircraft and operate the camera. The remote controller supports 65W fast charging and has a maximum operating time of 3 hours 18 minutes with the internal battery and up to 6 hours when used with an external WB37 Intelligent Battery. ^[2] The remote controller has a protection rating of IP54 (IEC 60529).

[1] The maximum flight time was tested in a lab environment and is for reference only.

[2] The maximum operating time of the remote controller was tested in a lab environment at room temperature. It is for reference only. Actual operating time may differ by scenario.

Feature Highlights

Both the aircraft system and the sensor system of the M350 RTK adopt a redundancy design to ensure flight safety. The added arm lock detection function can avoid the risk of unlocked arm sleeves. The FPV camera can clearly present the surroundings and obstacles during flight at night. The M350 RTK is designed with a six-directional binocular vision system and an infrared sensing system for six-directional awareness, positioning, and obstacle-sensing capabilities, providing comprehensive protection during flight. With the CSM Radar installed, M350 RTK can detect subtle obstacles upward or within the horizontal 360° range and avoid them in time. The built-in RTK module provides high accuracy of positioning. The IP rating of M350 RTK is IP55, and it is waterproof even when the aircraft arms are folded. The built-in DJI AirSense system detects nearby aircraft in the surrounding airspace, providing alerts in the DJI Pilot 2 app to ensure safety.

Intelligent functions: when using AI Spot-Check, M350 RTK can generate and store flight route files that can be used at any time to realize automated operation and make repetitive inspections after taking photos of subjects. A PinPoint can be added for a target to select a point of interest in the gimbal camera view, and the longitude and latitude can be recorded and

shared. M350 RTK supports Waypoint, Mapping, Oblique, and Linear Flight Missions. With DJI Terra, users can quickly obtain HD 2D and 3D digital results, enabling high-precision and high-efficiency mapping operations.

Multi-Payload Support: the M350 RTK supports a single downward gimbal, dual downward gimbals, and a single upward gimbal, meeting the needs of different operation scenarios. The E-Port open interface can shorten the development time sharply, and the three payload ports support DJI Payload SDK to expand application fields.

Preparing the Aircraft

Installing the Landing Gears

Insert the landing gear after aligning the red marks with the mounting position, slide the gear to the end of the landing gear, then rotate it until the red mark is in sync with the alignment mark.

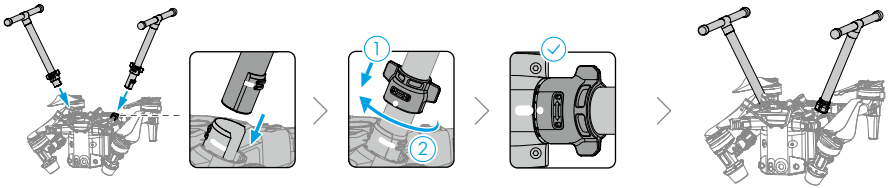

Unfolding the Aircraft

- Unfold the front frame arms and then the rear frame arms.
- Lock the frame arms and unfold the propellers.

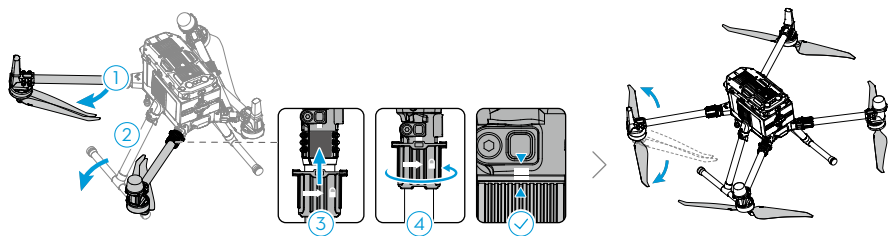

Mounting the Gimbal Camera

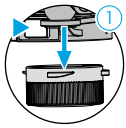

Press the gimbal detachment button to remove the cover.

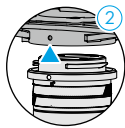

Align the white and red dots and insert the gimbal.

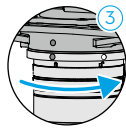

Rotate the gimbal lock to the locked position.

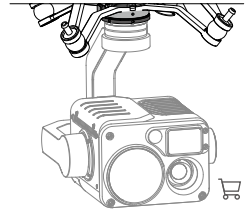

- After installation, make sure that the gimbal lock is locked in place.
- Make sure to press down the gimbal detachment button when rotating the gimbal lock to remove the gimbal camera. The gimbal lock should be fully rotated when removing the gimbal for the next installation.

Mounting the Intelligent Flight Batteries

Insert a pair of batteries and lock the battery release toggle.

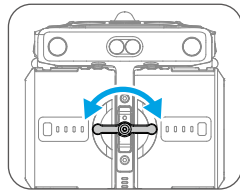
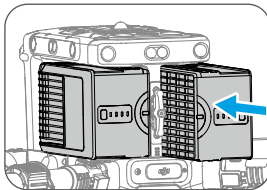

Check battery level: press the battery level button once.

Power on/off: press and then press and hold the power button to power on/off the aircraft.

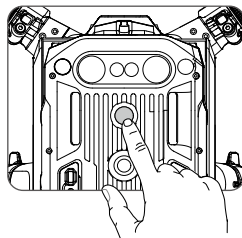
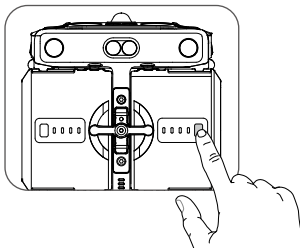

Flight Safety

This chapter provides information about flight environment requirements, wireless communication requirements, and important flight safety features of the aircraft.

Flight Safety

Make sure to have training and practice before operating any actual flight. Practice with the simulator in DJI Assistant 2 or fly under the guidance of experienced professionals. Pick a suitable area to fly in according to the following flight requirements and restrictions. Fly the aircraft below 120 m (400 ft). Any flight altitude higher than that may violate local laws and regulations. Make sure you understand and comply with the local laws and regulations before flying. Read the Safety Guidelines carefully to understand all safety precautions before flying.

Flight Environment Requirements

1. DO NOT use the aircraft in severe weather conditions such as where wind speeds exceed 12 m/s. When flying in rain, refer to the flight requirements listed in the IP55 Protection Rating section.
2. Place the aircraft on open and unobstructed flat ground to take off. Make sure the aircraft is at a safe distance from any surrounding obstacles, buildings, crowds, or trees. Fly the aircraft within the visual line of sight (VLOS) to ensure flight safety.
3. If light conditions surrounding the aircraft are poor, the navigation information on DJI Pilot 2 will show that the vision system or infrared sensing system is not functioning. This means the vision system and the infrared sensing system may not be working properly and the aircraft is unable to sense obstacles. Observe the surrounding environment at all times. Using the live FPV camera view and maintain control of the aircraft to ensure flight safety.
4. Make sure the beacons and the auxiliary lights are enabled at night for flight safety.
5. DO NOT take off from moving objects such as cars, ships, and airplanes.
6. DO NOT take off or land the aircraft on sandy or dusty areas to avoid affecting the motor service life.
7. The performance of the battery and the propulsion systems may be affected by the environment when flying in a high-altitude area. It is recommended to use 2112 High-Altitude Low-Noise Propellers.
8. The compass and GNSS will not work in Polar Regions. Fly carefully.
9. DO NOT use the aircraft, remote controller, battery, and battery station near accidents, fires, explosions, floods, tsunamis, avalanches, landslides, earthquakes, dust, or sandstorms.
10. Use the battery station in a temperature range of -20° to 40° C (-4° to 104° F).
11. DO NOT use the battery station in humid environments.
12. Make sure the temperature and humidity is suitable for the gimbal camera during usage.
13. This product shall not be used in potentially explosive atmosphere.

Wireless Communications Requirements

1. Make sure that the antennas are not damaged or loose.
2. Fly in wide open areas. Tall buildings, steel structures, mountains, rocks, or tall trees may affect the accuracy of the GNSS and block the video transmission signal.

3. Make sure to power off nearby Wi-Fi and Bluetooth devices when controlling the aircraft remotely to avoid interference with the remote controller from other wireless equipment.
4. Be extremely alert when flying near areas with magnetic or radio interference. Pay close attention to the video transmission quality and signal strength on DJI Pilot 2. Sources of electromagnetic interference include but are not limited to: high voltage lines, large scale power transmission stations or mobile base stations, and broadcasting towers. The aircraft may behave abnormally or lose control when flying in areas with too much interference. Return to the Home Point and land the aircraft if prompted to do so in DJI Pilot 2.

Operating the Aircraft Responsibly

Observe the following rules to avoid non-compliant behaviour, serious injury, and property damage:

- Make sure you are NOT drunk, taking drugs, under the influence of anesthesia, or suffering from dizziness, fatigue, nausea or any other conditions, whether physical or mental, that could impair your ability to operate the aircraft safely.
- Make sure the pilot has the A3 certificate.
- DO NOT operate in the vicinity of manned aircraft. DO NOT interfere with the operations of manned aircraft. Be alert and avoid other aircraft at all times. Land immediately if necessary.
- DO NOT fly the aircraft in venues of major events, including but not limited to sporting events and concerts.
- DO NOT fly the aircraft without authorization in areas prohibited by local laws. Prohibited areas include airports, national borders, major cities and densely populated areas, venues of major events, areas where emergencies have occurred (such as forest fires), and locations with sensitive structures (such as nuclear power plants, power stations, hydropower plants, correctional facilities, heavily traveled roads, government facilities, and military zones).
- DO NOT fly the aircraft above the authorized altitude.
- Keep your aircraft within visual line of sight (VLOS).
- DO NOT use the aircraft to carry illegal or dangerous goods or payloads.
- Make sure you understand the nature of your flight operation (such as for recreation, public, or commercial use) and have obtained the corresponding approval and clearance from the related government agencies before flight. Consult with your local regulators for comprehensive definitions and specific requirements. Note that remote controlled aircraft may be banned from conducting commercial activities in certain countries and regions. Check and follow all local laws and ordinances before flying as those rules may differ from those stated here.
- Respect the privacy of others when using the camera. DO NOT conduct surveillance operations such as video recording or capturing images of any person, entity, event, performance, exhibition, or property without authorization or where there is an expectation of privacy, even if the image or video is captured for personal use.
- Be advised that in certain areas, the recording of images and videos from events, performances, exhibitions, or commercial properties by means of a camera may contravene copyright or other legal rights, even if the image or video was shot for personal use.

Vision System and Infrared Sensing System

M350 RTK is equipped with a six-directional vision system and infrared sensing system, providing a positioning and obstacle-sensing ability.

The main components of the vision system are located on the front, rear, left, right, top, and bottom of the aircraft and include stereo vision sensors. The vision system uses image data to help the aircraft constantly scan for obstacles and obtain the positioning information of the aircraft. The infrared sensing system uses infrared modules to detect obstacles to judge the aircraft height, allowing the aircraft to maintain its current position and enabling precision hovering indoors or outdoors.

The infrared sensing system consists of two infrared sensors on the front, rear, left, right, top, and bottom of the aircraft. The downward vision system and infrared sensing system help the aircraft maintain its current position, hover more precisely, and fly indoors or outdoors where GNSS is unavailable.

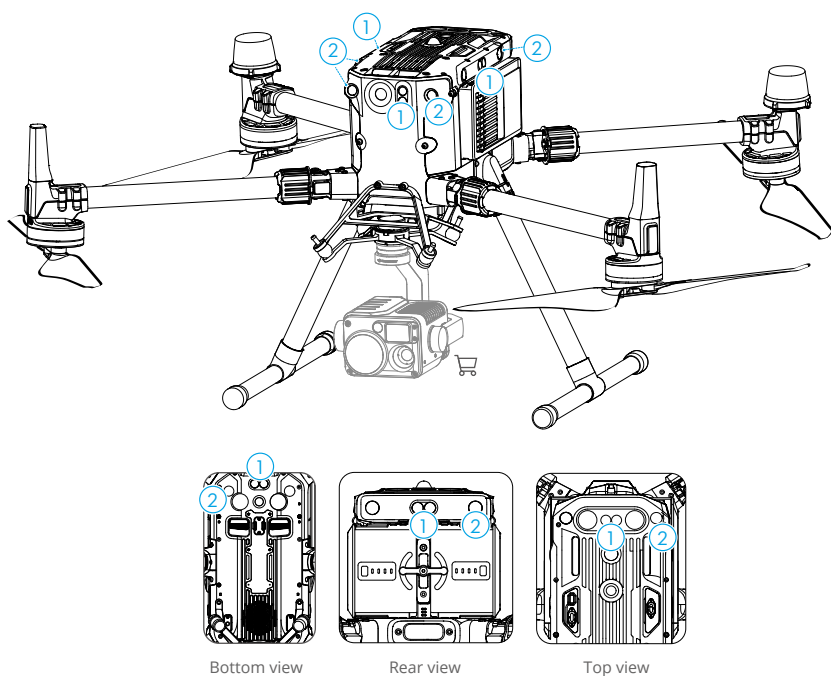

1. Infrared Sensing System
2. Vision System

⚠ • To ensure steady flight and general flight safety, DO NOT block the visual and infrared sensors.

Detection Range

Detection Range of the Vision System

Detection Distance: Upward/Downward: 0.6-30 m, Forward/Backward/Left/Right: 0.7-40 m

FOV: Forward/Backward/Downward: 65° (horizontal), 50° (vertical)

Left/Right/Upward: 75° (horizontal), 60° (vertical)

The detection range of the vision system is depicted below. Note that the aircraft cannot sense and avoid obstacles that are not within the detection range.

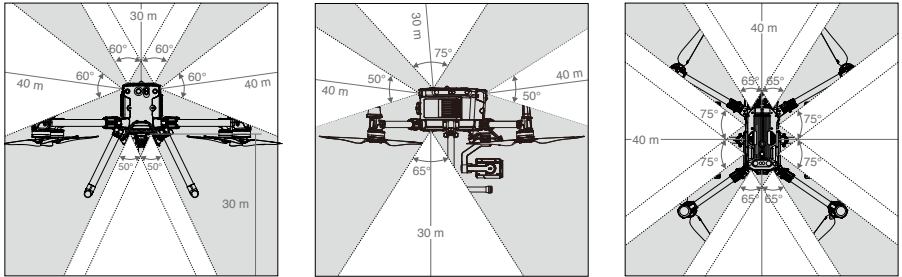

⚠ • The aircraft cannot detect objects in the grey area. Fly with caution.

☀ • Users can set the braking distance and warning distance in the DJI Pilot 2 app. The aircraft can automatically stop when flying near to the braking distance. Once the aircraft enters the warning distance, the obstacle information will be displayed as yellow. When the aircraft is close to the obstacle avoidance safety distance, the obstacle information will be displayed as red.

Detection Range of the Infrared Sensing System

Detection Distance: 0.1-8 m

FOV: 30°

Note that the aircraft cannot sense and avoid obstacles that are not within the detection range. The diagram shows the detection range of the upward infrared sensing system.

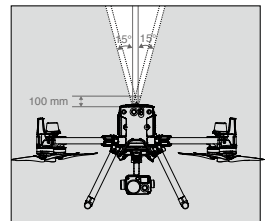

Not Obstruct Zone Note

There may be a $\pm 2^\circ$ error in the angle of the vision system due to errors in the assembly process. To prevent accidents, DO NOT attach any payload that might be in the sensors' Do Not Obstruct Zone. If the payload comes into the Do Not Obstruct Zone, it is recommended to turn off the vision system in the Pilot 2 app and fly with caution.

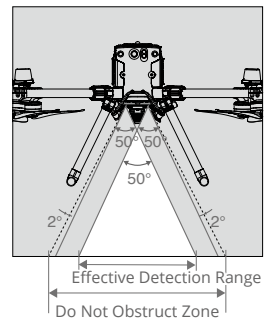

Calibration

The vision system cameras installed on the aircraft are factory calibrated. If the aircraft experiences a collision or the working temperature has changed significantly, it may require calibration via DJI Assistant 2 (Enterprise Series). Connect the aircraft to a computer and calibrate the vision system cameras when prompted in DJI Pilot 2.

1. Power on the aircraft.
2. Connect the aircraft and the PC with a USB-C cable.
3. Launch DJI Assistant 2 (Enterprise Series) and log in with a DJI account.
4. Click M350 RTK and the calibration button.
5. Follow the instructions of DJI Assistant 2 (Matrice Series) to enter the remote controller calibration. Make sure the remote controller touchscreen does not reflect any light before calibration. Face the calibration icon to the vision system and calibrate the six directional vision systems according to the instructions.

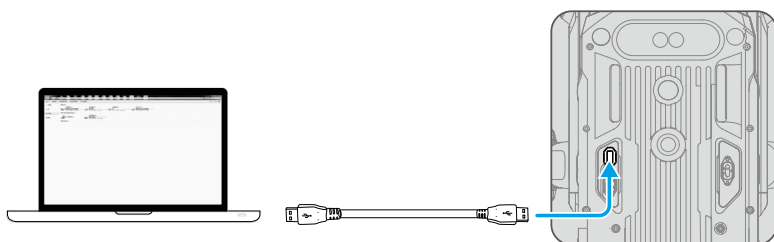

 • DO NOT power off or unplug the USB-C cable after calibration. Wait for data calculation.

Using the Vision System

The vision system enables precision hovering indoors or in environments where GNSS signal isn't available.

When the GNSS signal is available, the vision system provides auxiliary information for improving aircraft positioning accuracy. The vision system can work well when within 30 m from the ground and horizontal of 20 m of a wall or other objects to its side, requiring surfaces of clear patterns and adequate lighting.

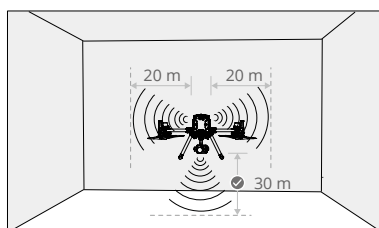

-
- ⚠ • If the vision system shuts down or is blocked by other objects, the aircraft will not be able to hover at a low altitude indoors and the Landing Protection Function that controls the landing speed will be disabled. Note: the aircraft may be damaged by landing too fast.
-

Assisted Braking from Obstacle Sensing

Powered by the vision system, the aircraft is able to actively brake when obstacles are detected in front. Obstacle sensing works best when lighting is adequate and the obstacle is clearly textured. The aircraft must fly at no more than 38 mph (62 kph) with a maximum pitch angle of 25° to allow for sufficient braking distance.

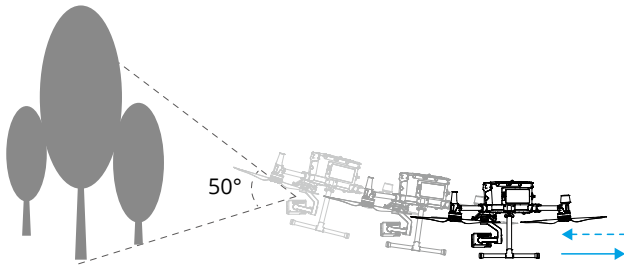

Using Infrared Sensing System



The infrared sensing system can only be used to avoid large, diffuse, and reflective obstacles (reflectivity >10%).

-
- ⚠ • The measurement accuracy of the vision system is easily affected by the light intensity and the surface texture of the object. The infrared sensing system can only be used to avoid large, diffuse, and reflective obstacles (reflectivity >10%).
- The vision system may NOT function properly when in any of the following situations:
 - a. Flying near monochrome surfaces (e.g., pure black, pure white, pure red, pure green) or without clear texture.
 - b. Flying near highly reflective surfaces.
 - c. Flying near water or transparent surfaces.
 - d. Flying near moving surfaces or objects (e.g. above moving people, waving reeds, shrubs and grass).
 - e. Flying in an area where the lighting changes frequently or drastically, or in an area where there is excessive exposure to direct, strong lighting.
 - f. Flying near extremely dark (< 15 lux) or bright (> 10,000 lux) surfaces.

- g. Flying at high speeds (over 14 m/s at 2 meters or over 5 m/s at 1 meter).
 - h. Tiny obstacles.
 - i. The lens is dirty (e.g., due to raindrops, fingerprints, etc.).
 - j. Scenes with low visibility (e.g., heavy fog).
- The infrared sensing system may NOT provide an accurate distance when in any of the following situations:
 - a. Flying near surfaces that can absorb sound waves (e.g., pure black matt objects).
 - b. There is a large area of strong reflectors beyond 15 m (for example, multiple traffic signs are placed side by side).
 - c. Tiny obstacles.
 - d. Mirrored or transparent objects (such as mirrors, water, and glass).
 - Keep sensors clean at all times. Dirt or other debris may adversely affect their effectiveness.
 - The vision system may not function properly when the aircraft is flying near water.
 - The vision system may not be able to recognize pattern on the ground in low light conditions (less than 100 lux).

Return to Home (RTH)

Return to Home (RTH) returns the aircraft to the last recorded Home Point when the positioning system is functioning normally. There are three types of RTH: Smart RTH, Low Battery RTH, and Failsafe RTH. The aircraft automatically flies back to the Home Point and lands when Smart RTH is initiated, the aircraft enters Low Battery RTH, or the video link signal is lost during flight.

	GNSS	Description
Home Point		The Home Point is recorded when the GNSS icon  is white during takeoff. The DJI Pilot 2 will give voice prompt when the Home Point is set.

-  • During RTH, the aircraft can sense and avoid obstacles when the forward vision system is enabled and lighting is sufficient.
- The aircraft cannot rotate or fly left or right during RTH.

Smart RTH

Press and hold the RTH button on the remote controller to initiate Smart RTH. The orientation of the aircraft cannot be controlled during RTH. Use the remote controller to control the aircraft's flight speed and altitude to avoid collision during the process. Press the RTH or Flight Pause button to exit Smart RTH and regain full control of the aircraft.

Smart RTH Procedure

1. The Home Point is recorded automatically.
2. RTH is triggered, i.e. Smart RTH or Low Battery RTH.
3. The Home Point is confirmed and the aircraft adjusts its orientation.
4. Return to Home (RTH):
 - a. Vision systems enabled: when less than 50 m (164 ft) from the Home Point, the aircraft will fly to the Home Point at the current altitude. If more than 50 m (164 ft) from the Home Point and below the pre-set RTH altitude, the aircraft will ascend to the pre-set RTH altitude before flying to the Home Point. The aircraft will fly directly to the Home Point if it is above the pre-set RTH altitude.
 - b. Vision systems disabled: if below the pre-set RTH altitude, the aircraft will ascend to the preset RTH altitude before flying to the Home Point. The aircraft will fly directly to the Home Point if it is above the pre-set RTH altitude.
5. The aircraft will return to the Home Point, and Landing Protection* will be triggered to allow the aircraft to land or hover in place. Refer to Landing Protection Function for details.

* Make sure that the downward vision system is enabled in DJI Pilot 2.

- ☀️ • The user can also exit RTH by pushing the control stick in the opposite direction of the flight (e.g., pushing the throttle stick down when the aircraft is ascending).

Low Battery RTH

To avoid unnecessary danger caused by insufficient power, the aircraft will automatically calculate if it has enough power to fly to the Home Point from its current location. A warning prompt will appear in DJI Pilot 2 when the battery level is low and the aircraft can only support Low Battery RTH. The aircraft will automatically fly to the Home Point if no action is taken after a 10-second countdown. Cancel RTH by pressing the RTH button or the Flight Pause button on the remote controller.

A low battery level warning will be prompted only once during a flight. If RTH is canceled following the warning, the Intelligent Flight Battery may not have enough power for the aircraft to land safely, which may lead to the aircraft crashing or being lost.

The aircraft will land automatically if the current battery level can only support the aircraft to descend from its current altitude. Auto landing cannot be canceled. During the forced landing process, users can control the throttle, pitch and roll sticks to fly the aircraft to the safe landing position, but the continuous descent action of the aircraft cannot be canceled.

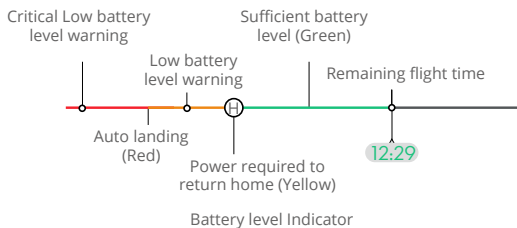

Battery Level Warning	Description	Flight Instructions
Low Battery RTH	The remaining battery level is only enough for the aircraft to fly to the Home Point safely.	If RTH is selected, the aircraft will fly to the Home Point automatically and landing protection will be enabled. Regain control of the aircraft and land it manually during RTH. ⚠️ The warning will not appear again after choosing not to use RTH. Decide carefully and ensure flight safety.
Auto Landing	The remaining battery level is only enough for the aircraft to descend from its current altitude.	The aircraft will land automatically and the landing protection will be enabled.
Estimated Remaining Flight Time	Estimated remaining flight time of the aircraft is based on its current battery level.	N/A
Low Battery Level Warning	Tap ●●● and tap 📷 in camera view to set the low battery level threshold value.*	Long beeps will sound from the remote controller. The user can still control the aircraft.
Critical Low Battery Level Warning	Tap ●●● and tap 📷 in camera view to set the critical low battery level threshold value.*	Short beeps will sound from the remote controller. The user can still control the aircraft. It is unsafe to continue flying the aircraft. Land immediately.

* The threshold value is different from that of Low Battery RTH or auto landing.





- ⚠️
- During auto landing, the user can push the throttle stick to make the aircraft hover at its current altitude or ascend, moving the aircraft to a more suitable landing location.
 - The colored zones and the estimated remaining flight time on the battery level indicator are automatically adjusted according to the aircraft's current location and status.

Failsafe RTH

Failsafe RTH is automatically enabled when the remote controller signal is lost for more than six seconds. RTH is the default failsafe action in the app.

Failsafe RTH includes two stages: Original Route RTH and Smart RTH. When Failsafe RTH is enabled, the aircraft will fly to the Home Point on its original flight route for a maximum distance of 50 m (164 ft), during which it will try to reconnect to the remote controller. If the aircraft cannot reconnect to the remote controller within 50 m (164 ft) or detects obstacles during RTH, the aircraft will exit Original Route RTH and enter the Smart RTH stage. The aircraft will remain in RTH mode even after the remote controller signal is restored. The user can use the remote controller to control the aircraft's flight speed and altitude, and exit RTH by pressing the RTH button on the remote controller.

RTH Safety Precautions

	<p>The aircraft cannot avoid obstacles during RTH when the forward vision system is disabled. However, the user can still control the speed and the altitude of the aircraft with the remote controller if a signal is available. Therefore, it is important to set a suitable RTH altitude before each flight. Launch DJI Pilot 2, enter the Preflight Check view or tap ••• and tap  in camera view to set the RTH altitude.</p>
	<p>If RTH is triggered when the aircraft is below 20 m (65 ft), the aircraft will automatically ascend to 20 m (65 ft) from the current altitude. The vertical speed can be adjusted using the throttle stick during ascent with a maximum descent speed of 1 m/s and ascent speed of 3 m/s.</p>
	<p>The RTH feature will be disabled when the GNSS signal is weak, or the GNSS is unavailable.</p>

Obstacle Sensing during RTH

The aircraft can sense and avoid obstacles during RTH if the lighting is sufficient for obstacle sensing. The obstacle sensing procedure is as follows:

1. The aircraft decelerates when an obstacle is sensed at approximately 20 m (65.62 ft) ahead.
2. The aircraft stops and hovers, then ascends to avoid the obstacle. Eventually, the aircraft stops ascending when it is at least 5 m (16.4 ft) above the detected obstacle.
3. The aircraft continues flying to the Home Point at its current altitude.

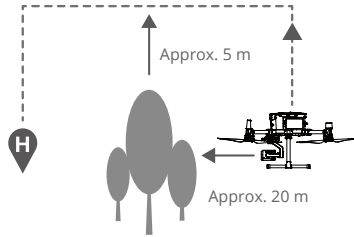

-
- ⚠ • Obstacle Sensing is disabled during RTH descent. Proceed with care.
 - To ensure the aircraft flies forward to the Home Point, the user is unable to rotate the aircraft during RTH while the vision system is enabled.
 - The aircraft cannot avoid obstacles beside or behind it.
-

Landing Protection

Landing protection is activated during auto landing and is executed as follows:

1. The aircraft will land directly if landing protection determines the ground is suitable for landing.
2. If the ground is determined unsuitable for landing, the aircraft will hover. A prompt will appear in DJI Pilot 2 pending the next action by the user. The aircraft will start descending only when the battery level drops to 0%. During this process, the user can still control the orientation of the aircraft.
3. If landing protection is not functioning, DJI Pilot 2 will display a landing prompt when the aircraft descends below 0.7 m (2.3 ft) above the ground. After making sure the environment is suitable for landing, tap to confirm or push the throttle stick all the way down and hold for one second, and the aircraft will land.

-
- ⚠ • Landing protection will not work in the following circumstances:
 - a. When the downward vision system is disabled.
 - b. When the user is operating the pitch/roll/throttle stick (landing protection will be re-activated when the control stick is not in use).
 - c. When the positioning system is not functioning properly (e.g., position drift errors).
 - d. When the vision system needs calibrating.
 - e. When the lighting is too dim for the vision system to operate.
-

Center of Gravity Calibration

The center of gravity will shift when the aircraft's payloads change. To ensure stable flight, it is required to recalibrate the aircraft's center of gravity when a new payload is installed.

- ☀️ • Calibrate in a windless environment. Make sure that the aircraft is hovering and there is a strong GNSS signal during calibration.
- Maintain visual line of sight of the aircraft and pay attention to flight safety.

Calibration instructions: go to flight control system settings in the app, and tap Center of Gravity Auto Calibration. The aircraft status indicators will glow solid purple during calibration. There will be a prompt in the app after calibration is completed.

Flight Recorder

Flight data is automatically recorded to the internal storage of the aircraft. You can connect the aircraft to a computer via the USB port and export this data via DJI Assistant 2 or DJI Pilot 2 app.

Flight Restrictions and Unlocking

GEO (Geospatial Environment Online) System

DJI's Geospatial Environment Online (GEO) system is a global information system that provides real-time information on flight safety and restriction updates and prevents UAVs from flying in restricted airspace. Under exceptional circumstances, restricted areas can be unlocked to allow flights in. Prior to that, the user must submit an unlocking request based on the current restriction level in the intended flight area. The GEO system may not fully comply with local laws and regulations. Users shall be responsible for their own flight safety and must consult with the local authorities on the relevant legal and regulatory requirements before requesting to unlock a flight in a restricted area.

GEO Zones

DJI's GEO system designates safe flight locations, provides risk levels and safety notices for individual flights, and offers information on restricted airspace. All restricted flight areas are referred to as GEO Zones, which are further divided into Restricted Zones, Authorization Zones, Warning Zones, Enhanced Warning Zones, and Altitude Zones. Users can view such information in real time in DJI Pilot 2. GEO Zones are specific flight areas, including but not limited to airports, large event venues, locations where public emergencies have occurred (such as forest fires), nuclear power plants, prisons, government properties, and military facilities. By default, the GEO system limits takeoffs and flights in zones that may cause safety or security concerns. A GEO Zone map that contains comprehensive information on GEO Zones around the globe is available on the official DJI website: <https://fly-safe.dji.com>.

Flight Restrictions in GEO Zones

The following section describes in detail the flight restrictions for the above mentioned GEO Zones.

GEO Zone	Flight Restriction	Scenario
Restricted Zones (Red)	UAVs are prohibited from flying in Restricted Zones. If you have obtained permission to fly in a Restricted Zone, please visit https://fly-safe.dji.com or contact flysafe@dji.com to unlock the zone.	Takeoff: the aircraft motors cannot be started in Restricted Zones.
		In Flight: when the aircraft flies inside a Restricted Zone, a 100-second countdown will commence in DJI Pilot 2. When the countdown is finished, the aircraft will land immediately in semi-automatic descent mode and turn off its motors after landing.
		In Flight: when the aircraft approaches the boundary of a Restricted Zone, the aircraft will automatically decelerate and hover.
Authorization Zones (Blue)	The aircraft will not be able to take off in an Authorization Zone unless it obtains a permission to fly in the area.	Takeoff: the aircraft motors cannot be started in Authorization Zones. To fly in an Authorization Zone, the user is required to submit an unlocking request registered with a DJI-verified phone number.
		In Flight: when the aircraft flies inside an Authorization Zone, a 100-second countdown will commence in DJI Pilot 2. When the countdown is finished, the aircraft will land immediately in semi-automatic descent mode and turn off its motors after landing.
Warning Zones (Yellow)	A warning will be displayed when the aircraft flies inside a Warning Zone.	The aircraft can fly in the zone but the user is required to understand the warning.
Enhanced Warning Zones (Orange)	When the aircraft flies in an Enhanced Warning Zone, a warning will be displayed prompting the user to confirm the flight path.	The aircraft can continue to fly once the warning is confirmed.

<p>Altitude Zones (Gray)</p>	<p>The aircraft altitude is limited when flying inside an Altitude Zone.</p>	<p>When the GNSS signal is strong, the aircraft cannot fly above the altitude limit.</p> <p>In Flight: when the GNSS signal changes from weak to strong, a 100-second countdown will commence in DJI Pilot 2 if the aircraft exceeds the altitude limit. When the countdown is finished, the aircraft will descend below the altitude limit and hover.</p> <hr/> <p>When the aircraft approaches the boundary of an Altitude Zone and the GNSS signal is strong, the aircraft will decelerate automatically and hover if the aircraft is above the altitude limit.</p>
------------------------------	--	--

- 
 • Semi-Automatic Descent: all stick commands except the throttle stick command and the RTH button are available during descent and landing. The aircraft motors will turn off automatically after landing. It is recommended to fly the aircraft to a safe location before the semi-automatic descent.

Buffer Zone

Buffer Zones for Restricted Zones/Authorization Zones: to prevent the aircraft from accidentally flying into a Restricted or Authorization Zone, the GEO system creates a buffer zone of about 20 meters wide outside each Restricted and Authorization Zone. As shown in the illustration below, the aircraft can only take off and land in place or fly toward an opposite direction of the Restricted or Authorization Zone when inside the buffer zone, and cannot fly toward the Restricted or Authorization Zone unless an unlocking request has been approved. The aircraft cannot fly back into the buffer zone after leaving the buffer zone.

Buffer Zones for Altitude Zones: a buffer zone of about 20 meters wide is established outside each Altitude Zone. As shown in the illustration below, when approaching the buffer zone of an Altitude Zone in a horizontal direction, the aircraft will gradually reduce its flight speed and hover outside the buffer zone. When approaching the buffer zone from underneath in a vertical direction, the aircraft can ascend and descend in altitude or fly in an opposite direction of the Altitude Zone, but cannot fly toward the Altitude Zone. The aircraft cannot fly back into the buffer zone in a horizontal direction after leaving the buffer zone.

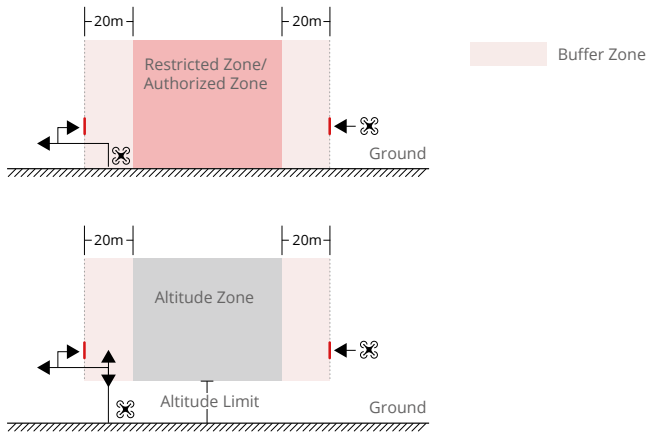

Unlocking GEO Zones

To satisfy the needs of different users, DJI provides two unlocking modes: Self-Unlocking and Custom Unlocking. Users may request for either on the DJI Fly Safe website or via a mobile device. Self-Unlocking is intended for unlocking Authorization Zones. To complete Self-Unlocking, the user is required to submit an unlocking request via the DJI Fly Safe website at <https://fly-safe.dji.com>. Once the unlocking request is approved, the user may synchronize the unlocking license through the DJI Pilot 2 app (Live Self-Unlocking) to unlock the zone; alternatively, the user may launch or fly the aircraft directly into the approved Authorization Zone and follow the prompts in DJI Pilot 2 to unlock the zone (Scheduled Self-Unlocking). For Live Self-Unlocking, the user can designate an unlocked period during which multiple flights can be operated. Scheduled Self-Unlocking is only valid for one flight. If the aircraft is restarted, the user will need to unlock the zone again.

Custom Unlocking is tailored for users with special requirements. It designates user-defined custom flight areas and provides flight permission documents specific to the needs of different users. This unlocking option is available in all countries and regions and can be requested for via the DJI Fly Safe website at <https://fly-safe.dji.com>.

Unlocking on Mobile Device: run the DJI Pilot 2 app and tap GEO Zone Map on the home screen. View the list of the unlocking licenses and tap ⓘ to view details of the unlocking license. A link to the unlocking license and a QR code will be displayed. Use your mobile device to scan the QR code and apply to unlock directly from the mobile device.

For more information about unlocking, please visit <https://fly-safe.dji.com> or contact flysafe@dji.com.

Maximum Altitude & Distance Restrictions

Maximum flight altitude restricts the aircraft flight altitude, while maximum flight distance restricts the aircraft flight radius around the Home Point. These limits can be set using the DJI Pilot 2 app for improved flight safety.

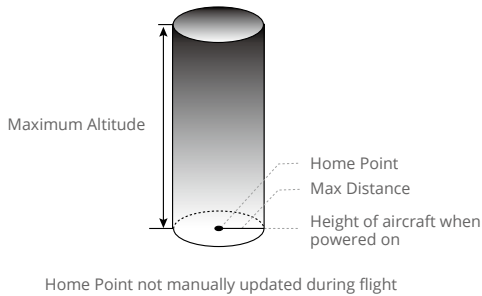

Strong GNSS Signal

	Restriction	Prompt in DJI Pilot 2
Max Altitude	Altitude of the aircraft cannot exceed the value set in DJI Pilot 2.	Aircraft approaching max flight altitude. Fly with caution.
Max Distance	The straight-line distance from the aircraft to the Home Point cannot exceed the max flight distance set in DJI Pilot 2.	Aircraft approaching max flight distance. Fly with caution.

Weak GNSS Signal

	Restriction	Prompt in DJI Pilot 2
Max Altitude	When the GNSS signal is weak, namely when the GNSS icon is yellow or red, and the ambient light is too dark, the max altitude is 3 m (9.84 ft). The max altitude is the relative altitude measured by the infrared sensor. When the GNSS signal is weak but the ambient light is sufficient, the max altitude is 30 m (98.43 ft).	Aircraft approaching max flight altitude. Fly with caution.
Max Distance	No limit	N/A

- ⚠ • In the case where an aircraft exceeds a specified limit, the pilot can still control the aircraft but is unable to fly the aircraft any closer to the restricted area.
- For safety reasons, DO NOT fly aircraft near airports, highways, railway stations, metro stations, city centers, or other sensitive areas. Only fly the aircraft in areas that are within your direct line of sight.

Calibrating the Compass

Only calibrate the compass when prompted to do so by the DJI Pilot 2 app or the aircraft status indicators. Observe the following rules when calibrating the compass.

- ☀️ • DO NOT calibrate the compass in locations with strong magnetic interference, such as near magnets, parking lots, or construction sites with underground reinforced concrete structures.
- DO NOT carry ferromagnetic materials such as mobile phones during calibration.
- The DJI Pilot 2 app will display a prompt if the compass is affected by strong interference after calibration is complete. Follow the displayed instructions to resolve the compass issue.

Calibration Procedure

Perform the calibration in an open area and follow the steps below to complete the calibration.

1. Run the DJI Pilot 2 app and enter camera view on the homepage. Tap **...** and tap **⌘**, then go to Sensor Status, Compass, and Calibrate Compass to start the calibration. The aircraft rear indicators will glow in solid yellow, which indicates that the calibration has started.
2. Rotate the aircraft 360 degrees. The aircraft rear indicators will glow in solid green.

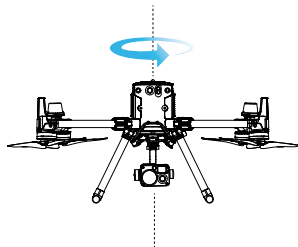

3. Hold the aircraft vertically with the nose pointing downward, and rotate the aircraft 360 degrees around the center axis.

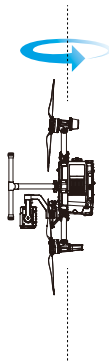

4. Re-calibrate the aircraft if the Aircraft Rear Indicators blink red.

- ⚠ • If the Aircraft Status Indicators blink red and yellow alternately after the calibration is complete, it indicates strong interference in the current location. Move the aircraft to a different location and try again.
- ☀ • A prompt will appear in DJI Pilot 2 if compass calibration is required before takeoff. The prompt will disappear after the calibration is complete.
- If the compass calibration is complete, place the aircraft on the ground. If the prompt appears again in DJI Pilot 2, try moving the aircraft to a different location before re-calibrating the compass.

Starting/Stopping the Motors

Starting Motors

The Combination Stick Command (CSC) is used to start the motors. Push both sticks to the bottom inner or outer corners to start the motors. Once the motors start spinning, release both sticks simultaneously.

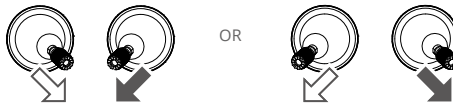

Stopping the Motors

There are two ways to stop the motors:

1. When the aircraft has landed, push and hold the throttle stick down until the motors stop. (Recommended).
2. When the aircraft has landed, conduct the same CSC that was used to start the motors. Release both sticks once motors stop.

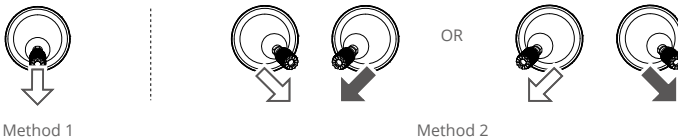

Method 1

Method 2

- ⚠ • If the motor is started unexpectedly, use CSC to stop motors immediately.

Emergency Propeller Stop

The Combination Stick Command (CSC) can be used to execute the emergency propeller stop once the flight controller detects critical error during flight.

Flight Test

Takeoff/Landing Procedures

1. Place the aircraft in an open, flat area with the battery level indicators facing towards you.
2. Turn on the remote controller, then turn on the aircraft.
3. Launch DJI Pilot 2 and enter the Camera View.
4. Wait until the Aircraft Status Indicators blink green.
5. If the Intelligent Flight Battery temperature is low, use the self-heating function to heat the batteries to ensure the temperature is suitable for the aircraft to take off.
6. Turn on the motors using CSC and push the throttle stick up slowly to take off.
7. To land, hover over a level surface and gently pull down on the left stick to descend.
8. After landing, hold the throttle stick at its lowest position until the motors stop.
9. Turn off the aircraft first, then the remote controller.



• Watch the tutorial video for more flight information.

Post-Flight Checklist

1. Perform visual inspection to make sure that the aircraft, remote controller, gimbal camera, Intelligent Flight Batteries, and propellers are in good condition. Contact DJI Support if there are any damages.
2. Make sure that the camera lens and vision system sensors are clean.
3. Make sure to store aircraft correctly before transporting it.

DJI AirSense

Airplanes with an ADS-B transceiver will actively broadcast flight information including locations, flight paths, speeds, and altitudes. DJI aircraft incorporated with the DJI AirSense technology are capable of receiving flight information broadcast from ADS-B transceivers that comply with 1090ES or UAT standards within a radius range of 10 kilometers. Based on the received flight information, DJI AirSense can analyze and obtain the location, altitude, orientation, and velocity of the surrounding manned airplanes, and compare such figures with the current position, altitude, orientation, and velocity of the DJI aircraft to calculate in real time the potential risk of collision with the surrounding manned airplanes. DJI AirSense will then display a warning message in DJI Pilot 2 according to the risk level.

DJI AirSense only issues warning messages on approaches by specific manned airplanes under special circumstances. Always fly the aircraft within your visual line of sight and be cautious at all times to ensure flight safety. Please be aware that DJI AirSense has the following limitations:

1. DJI AirSense can only receive messages sent by airplanes installed with an ADS-B Out device that is in compliance with 1090ES (RTCA DO-260) or UAT (RTCA DO-282) standards. DJI devices cannot receive broadcast messages from or display warnings on airplanes not equipped with properly functioning ADS-B Out devices.
2. If there is an obstacle between a manned aircraft and a DJI aircraft, DJI AirSense will not be able to receive ADS-B messages from the aircraft or send warnings to the user. Keenly observe your surroundings and fly with caution.
3. Warning prompts may be sent with delay if DJI AirSense experiences any interference from the surrounding environment. Keenly observe your surroundings and fly with caution.
4. Warning prompts may not be received if the DJI aircraft is unable to obtain information on its own location.
5. DJI AirSense cannot receive ADS-B messages from manned airplanes or send warnings to the user when it is disabled or misconfigured.

When a risk is detected by the DJI AirSense system, the AR projection display will appear on the current view in DJI Pilot 2, intuitively showing the distance between the DJI aircraft and the airplane, and issuing a warning alert. Users should follow the instructions in DJI Pilot 2 upon receiving the alert.

- a. Notice: a blue airplane icon will appear on the map.
- b. Caution: the app will display the message, Manned Aircraft detected Nearby. Fly with Caution. A small orange square icon with the distance information will appear on the camera view, and an orange airplane icon will appear on the map view.
- c. Warning: the app will display the message, Collision Risk. Descend or Ascend Immediately. If the user is not operating, the app will display, Collision risk. Fly with caution. A small red square icon with the distance information will appear on the camera view, and a red airplane icon will appear on the map view. The remote controller will vibrate to alert.

Pre-Flight Checklist

The pre-flight checklist can be used as a reference for pre-flight check in daily operations.

1. Make sure the remote controller and the aircraft batteries are fully charged, the TB65 batteries are installed firmly, and the battery release toggle is locked.
2. Make sure the propellers are securely mounted and not damaged or deformed, there are no foreign objects in or on the motors or propellers, the propeller blades and arms are unfolded, and the frame arms are locked.
3. Make sure the firmware of all devices are updated to the latest official version.
4. Make sure the lenses of the vision system, cameras, the glass of the infrared sensors, and the auxiliary lights are clean and not blocked in any way.
5. Make sure the covers of microSD card slot, the payload ports, and the dongle compartment have been closed firmly.
6. Make sure the remote controller antennas are adjusted to the proper position.

7. Power on the aircraft and the remote controller, toggle the flight mode switch to N-mode. Make sure the status LED and the aircraft authority button on the remote controller are solid green. This indicates that the aircraft and the remote controller are linked and the remote controller is in control of the aircraft.
8. Place the aircraft on open and flat ground. Make sure there are no obstacles, buildings, or trees nearby and that the aircraft is 5 m away from the pilot. The pilot should be facing the rear of the aircraft.
9. To ensure flight safety, enter the camera view of DJI Pilot 2 and check the parameters on the Preflight Check such as the control stick mode, RTH height, obstacle distance, and failsafe settings. It is recommended to set the failsafe action to RTH.
10. Divide the airspace for flight when multiple aircraft are operating simultaneously in order to avoid collision mid-air.
11. Check if the Remote ID is up to date and working.

Aircraft

This chapter introduces the major features of the aircraft.

Aircraft

The M350 RTK aircraft mainly consists of the flight control system, communication system, vision system, propulsion system, and power and battery system. This chapter provides a detailed introduction to the aircraft components and functions.

Activating the Aircraft

After the aircraft is linked to the remote controller (make sure the remote controller is connected to the internet), the DJI Pilot 2 app will display the prompt, There's a DJI device not activated. Follow the on-screen instructions to activate the aircraft. Contact DJI Support if the activation fails.

Aircraft Overview

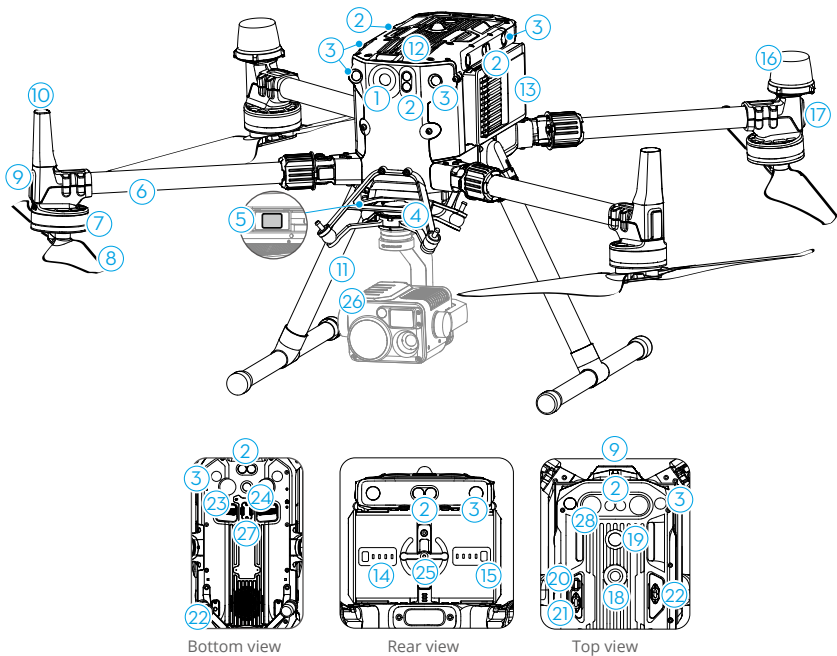

- | | |
|---------------------------------------|---------------------------|
| 1. FPV Camera | 6. Frame Arms |
| 2. Infrared Sensing System | 7. Motors |
| 3. Vision System | 8. Propellers |
| 4. DJI Gimbal Connector v2.0 (DGC2.0) | 9. Front LEDs |
| 5. Gimbal Detachment Button | 10. Transmission Antennas |

- | | |
|----------------------------------|--|
| 11. Landing Gears | 20. Assistant Port |
| 12. Air Filter | 21. E-Port |
| 13. Intelligent Flight Batteries | 22. Payload Port |
| 14. Battery Level Indicators | 23. Bottom Auxiliary Light |
| 15. Battery Level Button | 24. Downward Beacon |
| 16. GNSS Antennas | 25. Battery Locker |
| 17. Aircraft Status Indicators | 26. Gimbal Camera (purchased separately) |
| 18. Upward Beacon | 27. Top Auxiliary Light |
| 19. Power Button / Indicator | |

FPV Camera

The M350 RTK aircraft is equipped with a starlight FPV camera, which can optimize images in poor lighting conditions at night. It helps the pilot to have better visibility of the flight environment and fly safely.

Propellers

Using the Propellers

M350 RTK uses the 2110s propellers. The 2112 High-Altitude Low-Noise Propellers are purpose-built to improve the aircraft's maximum flight altitude while maintaining minimal flight noise.

Flight altitude limit is the maximum height that the aircraft can fly normally where the wind speed should not exceed 12 m/s. Note that the aircraft's braking and acceleration capabilities are reduced near to the flight altitude limit. Please read the diagram below to learn more about using the appropriate propellers by referring to the aircraft's weight and the expected maximum flight altitude.

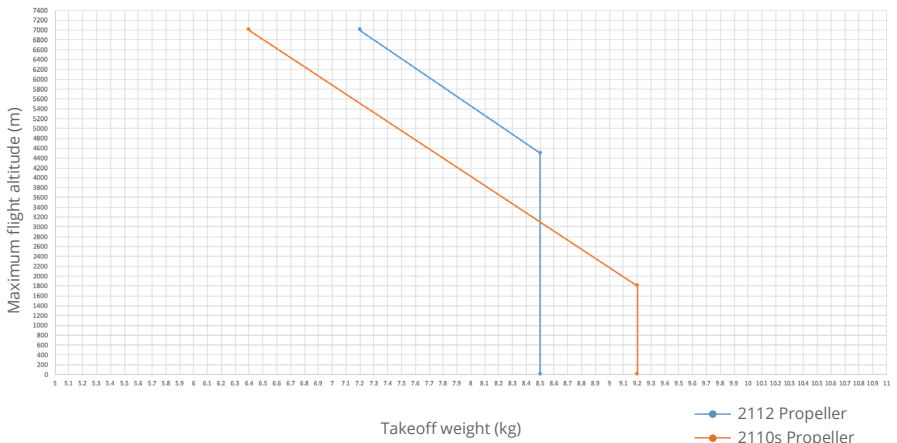

- ⚠ • Using High-Altitude Low-Noise Propellers will reduce the noise but will shorten the life of the motors to some degree.
- Only use official DJI propellers. DO NOT mix propeller types.
- Propellers are consumable components. Purchase additional propellers if necessary.
- Make sure that the propellers are installed securely before each flight.
- Make sure that all propellers are in good condition before each flight. DO NOT use aged, chipped, or broken propellers.
- To avoid injury, stay away from rotating propellers or motors.

Replacing the Propeller Blades

Use the H2.5 hex key to replace the propellers. Make sure to use the provided screws and proper screw glue (recommended model: 243) when replacing the propeller.

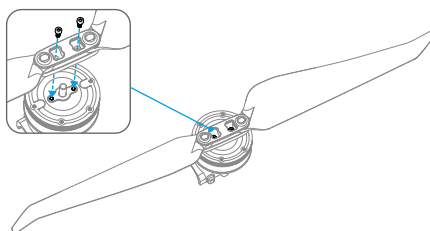

- ⚠ • The propeller blades are sharp. Handle with care.

Aircraft Indicators

The aircraft has front LEDs and aircraft status indicators.

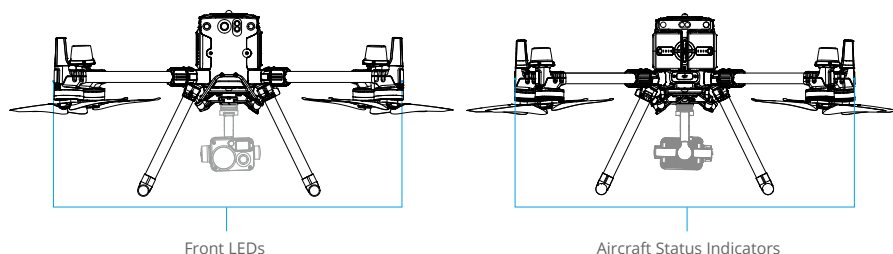

When the aircraft is powered on but the motors are not running, the front LEDs glow solid red to display the orientation of the aircraft.

When the aircraft is powered on but the motors are not running, the aircraft status indicators display the status of the flight control system. Refer to the table below for more information.

Normal States		
	Blinks red, green, yellow in sequence twice	Powering on and performing self-diagnostic tests
	Blinks green*	GNSS or RTK is used for positioning
	Blinks green twice*	Vision systems are used for positioning
	Blinks yellow slowly	Attitude mode (GNSS is not available)
Warning States		
	Blinks yellow quickly	Remote controller signal lost
	Blinks red slowly	Low battery level, takeoff is disabled**
	Blinks red quickly	Critically low battery level
	Blinks red for five seconds (when performing CSC)	IMU error
	Solid red	Critical error
	Blinks red and yellow alternately	Compass calibration required
	Blinks red and green alternately	RTK enabled but RTK data unavailable

After the motor starts, the front LEDs blink red and green alternately and the aircraft status indicators blink green. The green lights indicate the aircraft is a UAV and the red lights indicate the heading and position of the aircraft.

* Blinks green slowly in N-mode and fast in S-mode.

** If the aircraft cannot takeoff while the rear indicator is blinking red slowly, connect to the remote controller, run DJI Pilot 2, and view the details.

Aircraft Beacons

The upward and downward beacons on the aircraft enable you to find the aircraft when flying at night. The beacons can be manually turned on or off in DJI Pilot 2.

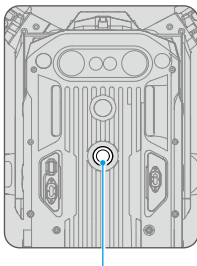

Upward Beacon

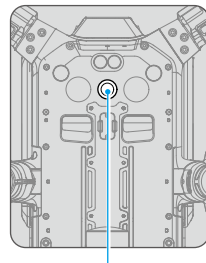

Downward Beacon

- ⚠ • DO NOT look directly at the beacons when they are in use to avoid damaging your eyes.

Aircraft Auxiliary Lights

The auxiliary lights located at the top and bottom of the aircraft will automatically turn on in poor light conditions to assist the downward vision system. The lights can also be manually turn on or off in DJI Pilot 2.

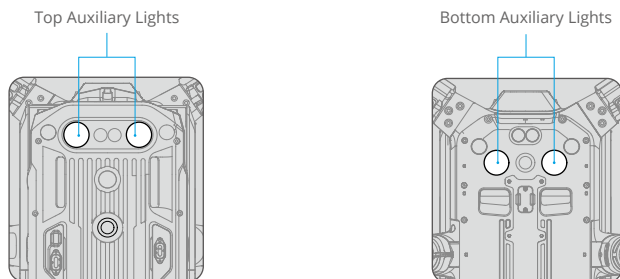

- ⚠ • The auxiliary lights will automatically turn on in low-light environments when the flight altitude is under 5 m. Note that the positioning performance of the vision systems may be affected. Fly with caution if the GNSS signal is weak.

Gimbal Camera

M350 RTK supports multiple payload configurations. See the table below for more details.

Payload combinations		Gimbal camera type
Single gimbal	Single upward gimbal	Zenmuse H20, Zenmuse H20T, PSDK payload
	Single downward gimbal	Zenmuse P1, Zenmuse L1, Zenmuse L2, Zenmuse H20, Zenmuse H20T, Zenmuse H20N, PSDK payload
Dual gimbals	Dual downward gimbals	Zenmuse H20, Zenmuse H20T, Zenmuse H20N, above single gimbal type+PSDK payload
	Single downward gimbal+Single upward gimbal	
Triple gimbals	Dual downward gimbals+Single upward gimbal	The above dual gimbal combinations+PSDK payload

- ☀ • Upward Gimbal Connector or Dual Gimbal Connector is required when using upward gimbal or dual gimbals. Refer to the Appendix section for more details. Refer to the related gimbal and camera user manual to learn how to use the gimbal camera.

Aircraft RTK

RTK Module Introduction

The built-in RTK module of the aircraft can withstand strong magnetic interference from metal structures and high-voltage lines, ensuring safe and stable flights. When used with a D-RTK 2 High Precision GNSS Mobile Station* (excluded) or a DJI-approved Custom Network RTK service, more accurate positioning data can be obtained.

* Both D-RTK 2 High Precision GNSS Mobile Station and D-RTK 2 High Precision GNSS Mobile Station for Matrice Series are supported.

Enabling/Disabling RTK

Ensure that the RTK function is enabled and RTK service type is correctly set (D-RTK 2 Mobile Station or Custom Network RTK) before each use. Otherwise, RTK cannot be used for positioning. Go to the camera view in the DJI Pilot 2 app, tap **•••** and then select RTK to check the settings. Make sure to disable the RTK function if not in use. Otherwise, the aircraft will not be able to take off when there is no differential data.



- RTK Positioning can be enabled and disabled during flight. Select the RTK Service Type first.
- After RTK is enabled, Maintain Positioning Accuracy Mode can be used.

DJI D-RTK 2 High Precision GNSS Mobile Station

1. Refer to the D-RTK 2 High Precision GNSS Mobile Station User Guide (available from <https://enterprise.dji.com/matrice-350-rtk/downloads>) to set up the D-RTK 2 Mobile Station and link the aircraft and the station. Power on the D-RTK 2 Mobile Station and switch to the Broadcast mode for the M350 RTK.
2. In the RTK settings in the app, select D-RTK 2 Mobile Station as the RTK service type, connect to the mobile station by following the on-screen instructions, and wait for the system to search for a satellite. When the status of the aircraft's positioning in the status table shows FIX, it indicates that the aircraft has obtained and used differential data from the mobile station.
3. D-RTK 2 Mobile Station communication distance: 12 km (NCC/FCC), 6 km (SRRC/CE/MIC).

Custom Network RTK

To use Custom Network RTK, make sure that the remote controller has a Wi-Fi connection. Custom Network RTK can be used to replace the D-RTK 2 Mobile Station. Connect the Custom Network RTK account to the designated NTRIP server to send and receive differential data. Keep the remote controller turned on and connected to the internet when using this function.

1. Make sure that the remote controller is connected to the aircraft and the internet.
2. Go to the camera view in the DJI Pilot 2 app, tap **•••** and then select RTK. Select Custom Network RTK as the RTK service type and fill in the required information. Then tap Save.
3. Wait to connect to the NTRIP server. In the RTK settings, when the status of the aircraft's positioning in the status table shows FIX, it indicates that the aircraft has obtained and used differential data from Custom Network RTK from the mobile station.

IP Rating

Under stable laboratory conditions, the M350 RTK achieves an IP55 protection rating by IEC60529 standards when equipped with TB65 Intelligent Flight Batteries. However, this protection rating is not permanent and may reduce over time after long-term use.

- ⚠ DO NOT fly when the amount of rainfall exceeds 100 mm / 24 h.
- Make sure the battery ports, battery compartment ports, battery surfaces, and battery compartment surfaces are dry before inserting the batteries.
- Make sure the battery ports and battery surfaces are free from any liquid before charging the batteries.
- Before packing the aircraft into the carrying case, ensure that it is free from any liquid by wiping it carefully.
- Product warranty does not cover water damage.

The aircraft does not achieve IP55 protection rating in the following circumstances:

- You use batteries other than the M350 RTK's TB65 Intelligent Flight Batteries.
- The cover for the ports are not attached correctly.
- The waterproofing top shell plug is not firmly attached to the top shell.
- The aircraft is broken due to various reasons, such as broken aircraft shell, failure of the waterproof adhesive, etc.

Expansion Ports

The three payload ports and one E-Port located on the top and bottom of the aircraft support SDK, enabling more feature development. Visit <https://developer.dji.com/> for more information about SDK development.

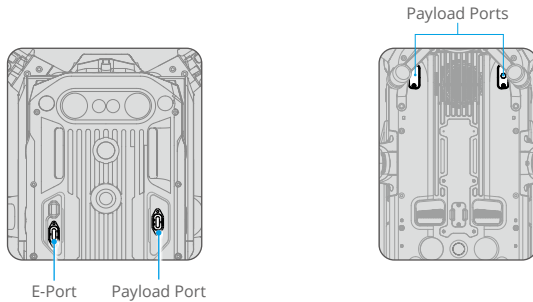

- ☀ • The three payload ports and the E-Port of M350 RTK support PSDK development. Payload port development requires SkyPort/X-Port accessories, and the power supply is 17.0 V/4 A and 13.6 V/4 A. The power supply of E-Port is 24 V/4 A. The total power of the four ports is limited to 180 W.

Remote Controller

This chapter introduces the features of the remote controller and includes instructions for controlling the aircraft.

Remote Controller

Starting and Activating the Remote Controller

Powering On/Off

Press once and then press again and hold for two seconds to power the remote controller on or off.

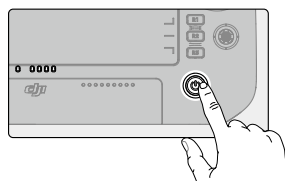

Activating the Remote Controller



The remote controller needs to be activated before first use. Make sure the remote controller has access to the internet during activation.

Follow the steps below to activate the remote controller:

1. Power on the remote controller. Select a language option and tap Next. Read the Terms of Use and Privacy Policy carefully and tap Agree, then select your country/region.
2. Connect to a Wi-Fi network to access the internet. Then set the time zone, date, and time.
3. If you have a DJI account, log in with your password. If you are a new user, create a DJI account and log in.
4. After logging in, tap Activate on the activation interface.
5. A prompt will appear on the screen, indicating that the remote controller is activated.
6. After activating the remote controller, choose if you would like to join the DJI Product Improvement Project. Join this project to help DJI better understand your needs.



- Check the internet connection if the activation fails. Make sure internet access is available and try activating the remote controller again. Contact DJI Support if the activation fails multiple times.

Remote Controller Overview

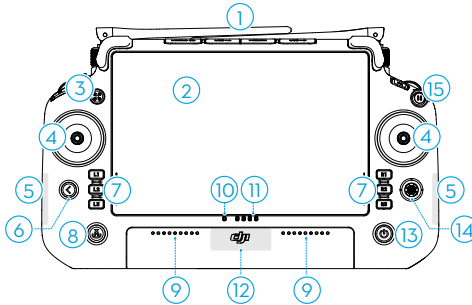

1. External Antennas
Transmit control and video wireless signals between the remote controller and the aircraft.
2. Touchscreen
Displays system and app views and supports up to 10 touch points. Make sure the touchscreen is clean, and completely dry before use. Otherwise, viewing and touch effects may be affected.
3. Aircraft Authority Button
When flying with a M350 RTK aircraft, the aircraft authority button is used to take control of the aircraft and indicate the aircraft control status. Refer to Guide on the home screen for more information.
4. Control Sticks
Flight control mode can be set in DJI Pilot 2.
5. Internal Wi-Fi Antennas
DO NOT block the internal Wi-Fi antennas during usage. Otherwise, the signal may be affected.
6. Back/Function Button
Press once to return to the previous screen. Press twice to return to the home screen. Use the back button and another button to activate combination buttons. Refer to the Combination Buttons section for more information.
7. L1/L2/L3/R1/R2/R3 Buttons
Go to camera view in DJI Pilot 2 to view the specific functions of these buttons.
8. Return to Home (RTH) Button
Press and hold to initiate RTH. Press again to cancel RTH.
9. Microphone
DO NOT block the microphones during usage.
10. Status LED
Indicates the status of the remote controller. View detailed descriptions of the Status LED in the Remote Controller LEDs and Alert section or in Guide on the home screen of the remote controller.
11. Battery Level LEDs
Display the current battery level of the remote controller. View detailed descriptions of the Battery Level LEDs in the Remote Controller LEDs and Alert section.
12. Internal GNSS Antennas
DO NOT block internal GNSS antennas during usage. Otherwise, the signal and the positioning accuracy may be affected.
13. Power Button
Press once to check the current battery level. Press once, then press again and hold for two seconds to power the remote controller on or off. When the remote

controller is powered on, press once to turn the touchscreen on or off.

14. 5D Button

View the default 5D button functions in DJI Pilot 2. Refer to Guide on the home screen for more information.

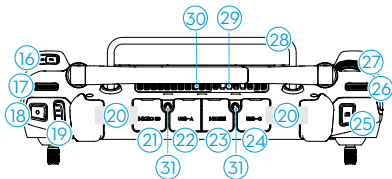

16. C3 Button

Customize functions in DJI Pilot 2.

17. Left Dial

Controls the tilt of the gimbal.

18. Record Button

Press once to start or stop recording.

19. Flight Mode Switch

For switching between three flight modes: N-mode (Normal), S-mode (Sport), and F-mode (Function). F-mode can be set to A-mode (Attitude) or T-mode (Tripod) in DJI Pilot 2.

20. Internal Antennas

Transmit aircraft control and video wireless signals. DO NOT block the internal antennas during usage. Otherwise, the signal may be affected.

21. microSD Card Slot

For inserting a microSD card.

22. USB-A Port

When flying with a Matrice series aircraft, users can connect the remote controller to a intelligent battery station for firmware updates. Users can also insert

15. Flight Pause Button

Press once to have the aircraft brake and hover in place (only when GNSS or vision systems are available).

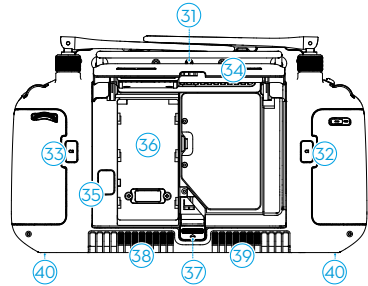

third-party devices, such as a USB flash drive or a memory card.

23. HDMI Port

For outputting HDMI signal to an external monitor.

24. USB-C Port

For charging the remote controller.

25. Focus/Shutter Button

Press the button halfway down for autofocus and all the way down to take a photo.

26. Right Dial

Controls the pan of the gimbal.

27. Scroll Wheel

For adjusting camera zoom.

28. Handle

29. Speaker

30. Air Vent

For heat dissipation. DO NOT block the air vent during usage.

31. Reserved Mounting Holes

For mounting external devices.

- | | |
|---|---|
| <p>32. C1 Button
Customize functions in DJI Pilot 2.</p> <p>33. C2 Button
Customize functions in DJI Pilot 2.</p> <p>34. Rear Cover</p> <p>35. Battery Release Button</p> <p>36. Battery Compartment
For installing the WB37 intelligent battery.</p> | <p>37. Rear Cover Release Button</p> <p>38. Alarm</p> <p>39. Air Intake
For heat dissipation. DO NOT block the air intake during usage.</p> <p>40. M4 Screw Holes
For mounting the strap bracket.</p> |
|---|---|

Mounting the WB37 Intelligent Battery

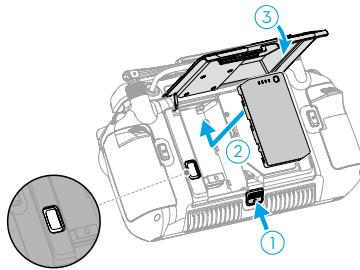

1. Push the rear cover release button to the end to open the rear cover.
2. Insert the WB37 battery into the battery compartment and push forward until it clicks firmly in place.
3. Close the rear cover.



• To remove the WB37 battery, press and hold the battery release button.

Mounting the Strap and Bracket Kit

A strap and bracket (excluded) can be mounted onto the remote controller in the following steps.

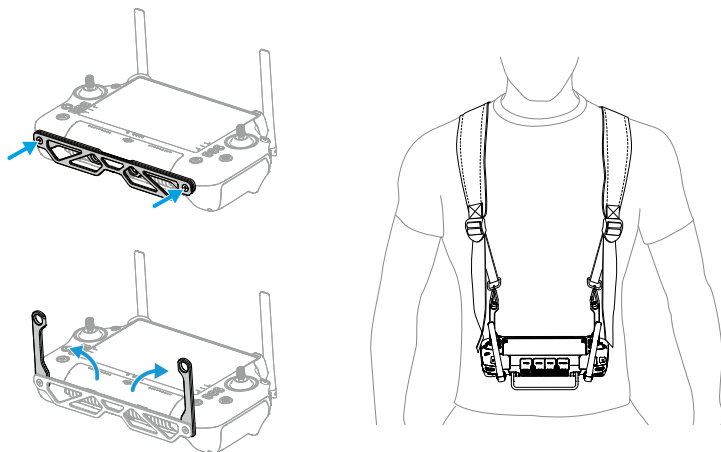

1. Mount the bracket on the remote controller with two screws.
2. Unfold the two handles.
3. Wear the strap, and attach the strap hooks to the handle holes.

⚠️ • After use, hold the remote controller with one hand, unlock the strap hooks with the other hand to remove the remote controller, and then take off the strap.

Adjusting the Antennas

Lift and adjust the antennas. The strength of the remote controller signal is affected by the position of the antennas.

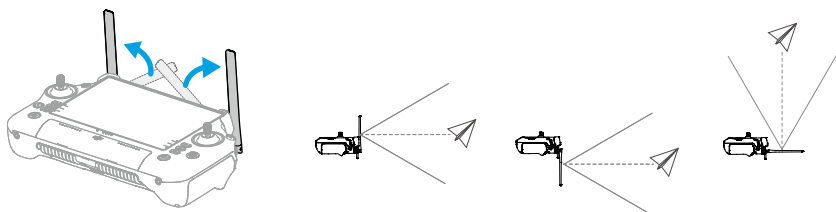

Adjust the direction of the external antennas and make sure their flat side is facing the aircraft, so that the controller and aircraft are within the optimal transmission zone.

-
- ⚠ • DO NOT overstretch the antennas to avoid damage. Contact DJI Support to repair the remote controller if the antennas are damaged. A damaged antenna will greatly decrease the performance of the remote controller and might affect flight safety.
 - During the flight, DO NOT use other 2.4 GHz or 5.8 GHz communication devices in the same frequency band at the same time, so as not to interfere with the communication signal of the remote controller. Such as enable the mobile phone Wi-Fi.
 - A prompt will appear in DJI Pilot 2 if the transmission signal is weak during flight. Adjust the antennas to make sure that the aircraft is in the optimal transmission range.
-

IP Rating

The DJI RC Plus remote controller has been tested in a lab environment and rated IP54 in accordance with the global IEC 60529 standard. The protection rating is not permanent, however, and may lower over an extended period.

-
- ⚠ • DO NOT use the remote controller when the precipitation exceeds 50 mm in 24 hours.
 - DO NOT open any cover in the rain, including the external port cover, remote controller rear cover, dongle compartment cover, or air vent and air intake covers. DO NOT mount or remove control sticks or antennas in the rain. Before opening any cover or removing the control sticks or antennas, move the remote controller indoors and make sure it is clean and completely dry.
 - When using the remote controller in the rain, make sure all covers are attached firmly and control sticks are screwed in place securely.
 - It is normal to have water stains around the port when opening the port cover after use. Wipe off water stains before using the external port.
 - The product warranty does not cover water damage.
-

The remote controller is not qualified for an IP54 rating in the following circumstances:

- a. The cover of the external port is not attached firmly.
- b. The remote controller rear cover is not attached firmly.
- c. The air vent and air intake covers are not installed firmly.
- d. The dongle compartment cover is not attached firmly.
- e. The control sticks are not screwed in place securely.
- f. Antennas are not screwed in place securely.
- g. The remote controller has suffered other damage such as a cracked shell or compromised waterproof adhesive.

User Interface

Home Screen

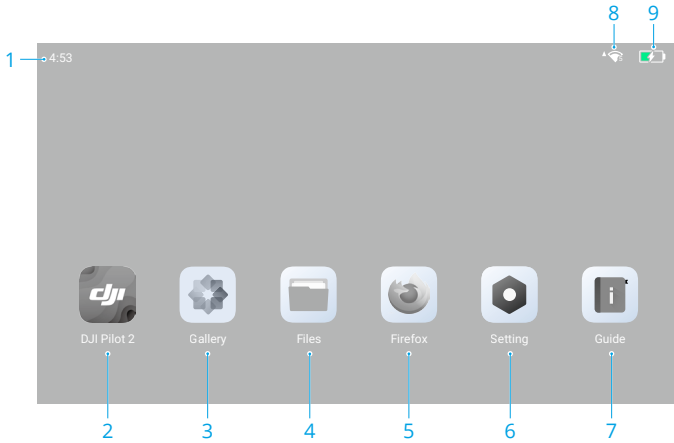

1. Time
Displays local time.
2. DJI Pilot 2
Tap to open DJI Pilot 2.
3. Gallery
Tap to view stored images and videos.
4. Files
Tap to view stored files.
5. Browser
Tap to open the browser.
6. Settings
Tap to open system settings.
7. Guide
Tap to read the guide with concise information on the remote controller buttons and LEDs.
8. Wi-Fi Signal
Displays Wi-Fi signal strength when connected to a Wi-Fi network. Wi-Fi can be enabled or disabled in the shortcut settings or in the system settings.
9. Battery Level
Displays the battery level of the internal battery of the remote controller. The battery level of the external WB37 intelligent battery will also be displayed when installed. The icon  indicates that the battery is charging.

Screen Gestures

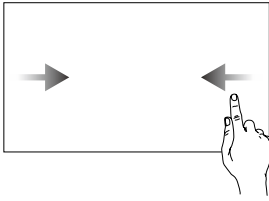

Slide from the left or right to the center of the screen to return to the previous screen.

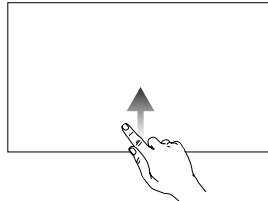

Slide up from the bottom of the screen to return to the home screen.

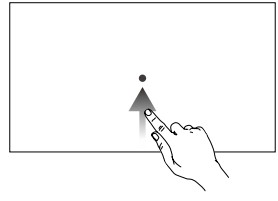

Slide up from the bottom of the screen and hold to access recently opened apps.

Shortcut Settings

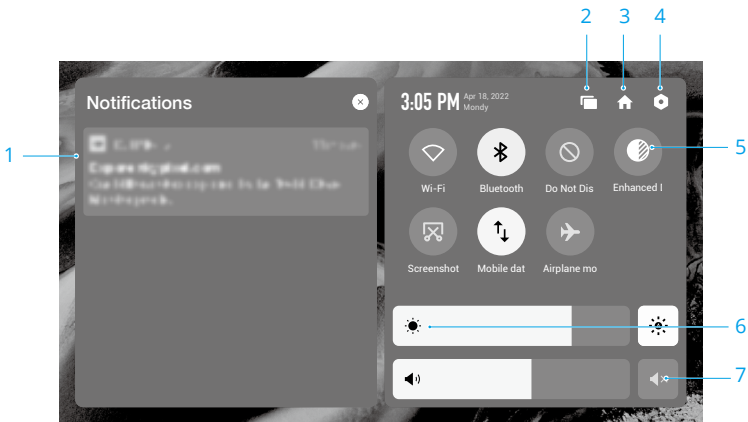

1. Notifications

View system or app notifications.

2. Recent

Tap  to view and switch to recently opened apps.

3. Home

Tap  to return to the home screen.

4. System Settings

Tap  to access system settings.

5. Shortcuts

 : Tap to enable or disable Wi-Fi. Hold to enter settings and connect to or add a Wi-Fi network.

 : Tap to enable or disable Bluetooth. Tap and hold to open settings and connect with nearby Bluetooth devices.

 : Tap to enable DO NOT Disturb mode. In this mode, system prompts will be disabled.

 : Display enhancement. Once enabled, the display brightness is enhanced to assist in shooting. However, there are differences between the source and display effect, while the source photo or video taken by the aircraft is not affected.



 : Tap to start screen recording.

 : Tap to screenshot the screen.

 : Mobile data. Tap to turn mobile data on or off; long press to set mobile data and diagnose network connection status.

 : Tap to enable Airplane mode. Wi-Fi, Bluetooth, and mobile data will be disabled.

6. Adjust Brightness

Slide the bar to adjust the brightness. Tap the icon  to auto-brightness mode. Tap the  icon or slide the bar to switch to manual brightness mode.

7. Adjust Volume

Slide the bar to adjust the volume and tap  to mute. Note that after muting, all sounds of the remote controller will be completely disabled, including related alarm sounds. Turn on the mute with caution.

Video Transmission

M350 RTK aircraft features O3 Enterprise, which enables triple-channel 1080p video transmission and supports Single Operator or Advanced Dual Operator mode.

1. When in Single Operator mode, the remote controller supports dual-channel 1080p video transmission.
2. When in Advanced Dual Operator mode, the remote controller supports triple-channel 1080p video transmission and allows seamless swapping between input feeds.

Remote Controller LEDs and Alert

Remote Controller LEDs

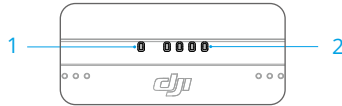

1. Status LED

The status LED indicates the status of the remote controller, the aircraft, and the link between them.

Blinking Patterns	Descriptions
— Solid red	Disconnected with aircraft
..... Blinking red	Low aircraft battery level
— Solid green	Connected with aircraft
..... Blinking blue	The remote controller is linking to an aircraft
— Solid yellow	Firmware update failed
..... Blinking yellow	Low remote controller battery level
..... Blinking cyan	Control sticks not centered

2. Battery Level LEDs

The battery level LEDs indicate the battery level of the remote controller.

Battery Level LEDs				Battery Level
				88%~100%
				75%~87%
				63%~74%
				50%~62%
				38%~49%
				25%~37%
				13%~24%
				0%~12%

Remote Controller Alert

The remote controller vibrates or beeps twice to indicate an error or warning. For detailed information, see the real-time prompts on the touchscreen or in DJI Pilot 2. Swipe down from the top of the screen to open Shortcut Settings and turn on Mute mode to disable all voice alerts.

Any voice prompts and alerts will be disabled in Mute mode, including alerts during RTH and low battery alerts for the remote controller or aircraft. Use with caution.

Charging the Remote Controller and Checking the Battery Level

Charging the Remote Controller

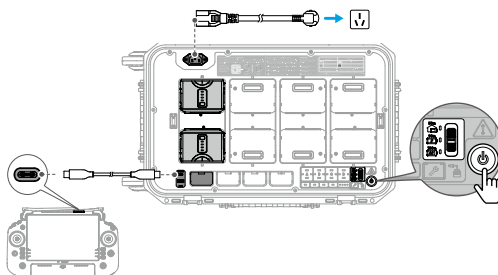

1. Connect the BS65 Intelligent Battery Station to a power outlet using the AC power cable, and press the power button once to power on the battery station.
2. Connect the battery station and the remote controller USB-C ports using a USB-C to USB-C cable.
3. The battery level LEDs start to flash to indicate that the Internal battery is activated and charging started.
4. It takes approximately 2 hours to fully charge the remote controller internal battery.

- ☀ • It is recommended to use the DJI BS65 Battery Station for charging. Otherwise, use a certified USB-C charger with a maximum rated power of 65 W and maximum voltage of 20 V such as the DJI 65W Portable Charger.
- Fully discharge and charge the remote controller every three months. The battery depletes when stored for an extended period.
- If a WB37 battery is installed in the remote controller, the WB37 battery will be charged at the same time. The WB37 battery can also be charged by inserting to the BS65 battery station.

- ⚠ • The remote controller cannot be powered on before activating the internal battery. The internal battery of the remote controller can also be activated after mounting the WB37 battery.
- Make sure to use the included USB-C to USB-C cable for optimal charging.

Charging Options

1. The internal battery of the remote controller can be charged with a charging device or the inserted external WB37 battery. It takes approximately two hours to fully charge the internal battery with a charging device. The internal battery can be charged up to 50% with the external battery. Charging with the external battery is not possible after the remote controller is powered off.

2. Duration for fully charging a WB37 battery with 0% power:
 - a. When mounted on the remote controller and the internal battery level is 0%, it takes approximately 2 hours while fully charging the internal battery.
 - b. When mounted on the remote controller and the internal battery level is 100%, it takes approximately 1 hour and 10 minutes.
 - c. When inserted into the BS65 battery station, it takes approximately 1 hour and 20 minutes.

 • The charging time may vary with the ambient temperature.

Charging Mechanism

1. When the remote controller is connected with both a charging device and an external battery, the remote controller will be powered by the charging device.
2. When the external battery is mounted and the remote controller is not connected with a charging device, the remote controller will be powered by the external battery. When the external battery is depleted, the remote controller will be powered by the internal battery.

Checking the Battery Level

Checking the Internal Battery Level

Press the power button once to check the current battery level.

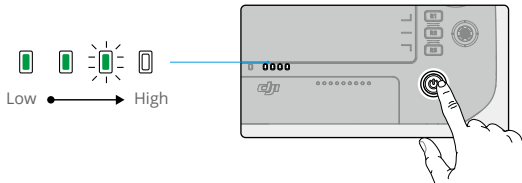

Checking the External Battery Level

Press the power button on the external battery, and the LEDs will indicate the current battery level of the external battery.

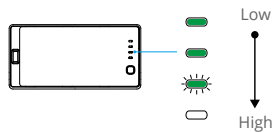

 • Alternatively, go to the home screen of the remote controller and check the battery levels of both the internal and external batteries on the status bar.

Linking the Remote Controller and Control Stick Modes

Linking the Remote Controller

The remote controller is already linked to the aircraft when it is purchased together as part of a combo. Otherwise, follow the steps below to link the remote controller and the aircraft after activation.

Method 1: Using Combination Buttons

1. Power on the remote controller and the aircraft.
2. Press the C1, C2, and Record buttons simultaneously until the status LED blinks blue and the remote controller beeps twice.
3. Press and hold the power button on the aircraft for at least five seconds. The aircraft power indicator will blink and will beep twice to indicate linking has started. When linking is successful, the aircraft status indicators will blink green while the remote controller will beep twice, and the remote controller status LEDs will turn solid green.

Method 2: Using DJI Pilot 2

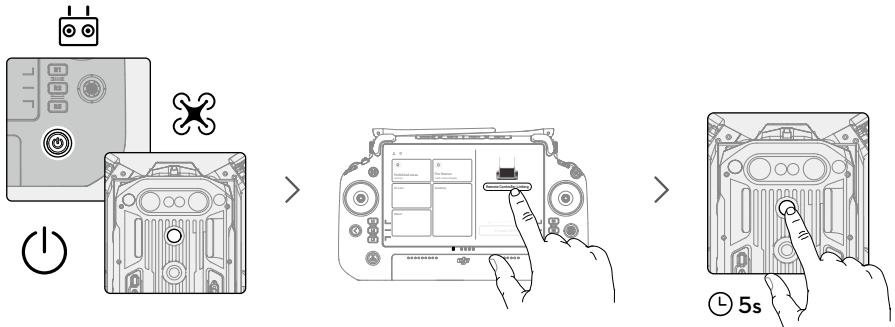

1. Power on the aircraft and the remote controller.
2. Run DJI Pilot 2 and tap Link Remote Controller to link. The status LED of the remote controller will blink blue, and the remote controller will beep during linking.
3. Press and hold the power button on the aircraft for at least five seconds. The aircraft power indicator will blink and will beep twice to indicate linking has started. When linking is successful, the aircraft status indicators will blink green while the remote controller will beep twice, and the remote controller status LEDs will turn solid green.



- Make sure the remote controller is within 50 cm (1.6 ft) of the aircraft during linking.
- Make sure the remote controller is connected to the internet when logging in using a DJI account.

Control Stick Mode

There are three pre-programmed modes in DJI Pilot 2. The modes are Mode 1, Mode 2, and Mode 3.

Mode 1

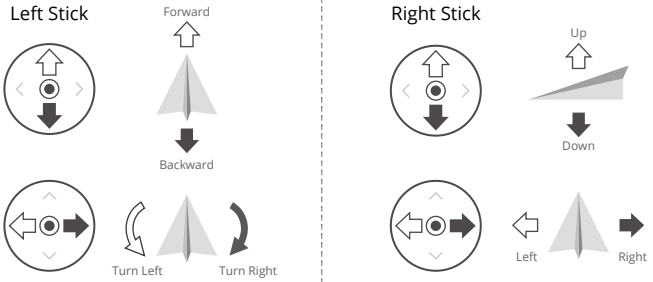

Mode 2

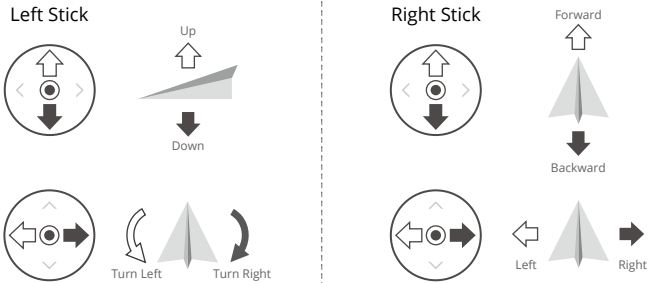



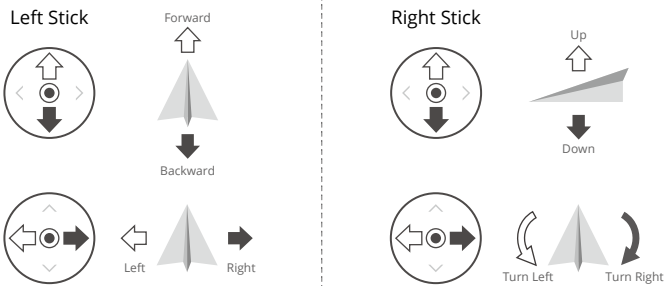



Mode 3

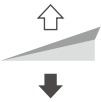

The default mode is Mode 2. See the figures below to check the function of each control stick in the three pre-programmed modes.

 Center position: control sticks are centered.

Moving the control stick: control sticks are pushed away from the center.

Remote Controller (Mode 2)	Aircraft	Remarks
		<p>Moving the left stick up or down changes the aircraft's altitude.</p> <p>Push the stick up to ascend and down to descend. The more the stick is pushed away from the center position, the faster the aircraft will change altitude. Push the stick gently to prevent sudden and unexpected changes in altitude.</p>
		<p>Moving the left stick to the left or right controls the orientation of the aircraft.</p> <p>Push the stick left to rotate the aircraft counter-clockwise and right to rotate the aircraft clockwise. The more the stick is pushed away from the center position, the faster the aircraft will rotate.</p>
		<p>Moving the right stick up and down changes the aircraft's pitch.</p> <p>Push the stick up to fly forward and down to fly backward. The more the stick is pushed away from the center position, the faster the aircraft will move.</p>
		<p>Moving the right stick to the left or right changes the aircraft's roll.</p> <p>Push the stick left to fly left and right to fly right. The more the stick is pushed away from the center position, the faster the aircraft will move.</p>

-  • Keep the remote controller away from magnetic materials such as magnets and loudspeaker boxes to avoid magnetic interference.
- To avoid damage to the control sticks, it is recommended that the remote controller be stored in the carrying case when being carried or transported.

Buttons Overview

RTH Button

Press and hold the RTH button until the remote controller beeps twice to start RTH. The aircraft will fly to the last updated Home Point. Press the button again to cancel RTH and regain control of the aircraft.

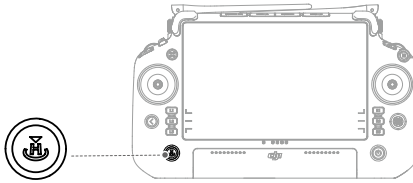

- In Advanced Dual Operator mode, the user cannot start or cancel RTH using the RTH button on the remote controller that does not have aircraft control.

L1/L2/L3/R1/R2/R3 Buttons

The remote controller will automatically switch the functions of these buttons depending on the camera type on the aircraft. Find the descriptions of these button functions next to the L1/L2/L3/R1/R2/R3 buttons after running DJI Pilot 2.

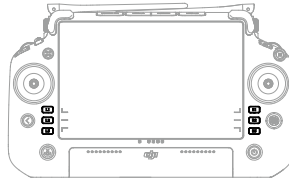

Button Customization and Combinations

Customizable Buttons

The C1, C2, C3, and 5D buttons are customizable. Open DJI Pilot 2 and enter camera view. Tap ... and tap  to configure the functions of these buttons. In addition, combination buttons can be customized using the C1, C2, and C3 buttons with the 5D button.

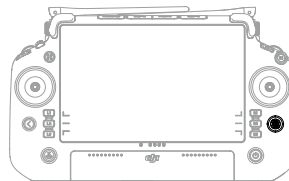
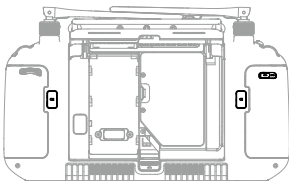

Combination Buttons

Some frequently-used features can be activated by using combination buttons. To use combination buttons, hold the back button and operate the other button in the combination. In actual use, enter the home screen of the remote controller, and tap Guide to quickly check all available combination buttons.

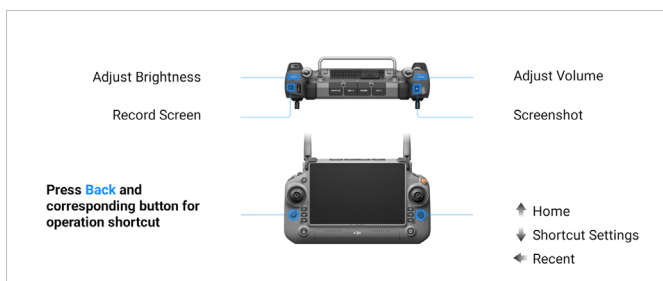

The default combination buttons cannot be changed. The following table displays the function of each default combination button.

Combination Operation	Function
Back Button + Left Dial	Adjust Brightness
Back Button + Right Dial	Adjust Volume
Back Button + Record Button	Record Screen
Back Button + Shutter Button	Screenshot
Back Button + 5D Button	Toggle up - Home; Toggle down - Shortcut settings; Toggle left - Recently opened apps

Flight Mode Switch

Toggle the switch to select a flight mode.

Icon	Flight Mode
F	F-mode (Function)
S	S-mode (Sport)
N	N-mode (Normal)

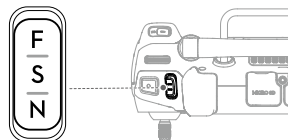

The flight control system of the M350 RTK aircraft supports the following flight modes:

N-mode (Normal)

The aircraft utilizes the GNSS and the vision system that allows for obstacle sensing in six directions to automatically stabilize itself. When the GNSS signal is strong, the aircraft uses the GNSS to locate and stabilize itself. When the GNSS signal is weak but the lighting and other environment conditions are sufficient, the aircraft uses the vision systems to locate and stabilize itself. When obstacle sensing is enabled and the lighting and other environment conditions are sufficient, the maximum tilt angle of the aircraft will be 25°. When the GNSS signal is weak and the lighting and other environment conditions are insufficient, the aircraft cannot hover precisely and can only maintain its altitude using the barometer.

S-mode (Sport)

The aircraft utilizes the GNSS and downward vision system to hover precisely. By adjusting the gain and expo settings, the maximum flight speed of the aircraft can be increased to 23 m/s. When in S-mode, obstacle sensing in the four horizontal directions will be disabled, and the aircraft cannot detect or bypass obstacles in these directions. The upward and downward vision systems work normally in S-mode.

F-mode (Function)

F-mode can be set to T-mode (Tripod mode) or A-mode (Attitude mode) in DJI Pilot 2. T-mode is based on N-mode. The flight speed is limited to allow easier control of the aircraft. A-mode must be used with caution. In A-mode, the vision systems are disabled. The aircraft cannot position itself or brake automatically in this mode and is easily affected by its surroundings, which may result in horizontal shifting.



- Obstacle sensing is disabled in S-mode, which means the aircraft cannot sense and brake to avoid obstacles automatically. Pay attention to the surrounding environment and obstacles on the route when flying the aircraft in S-mode.
 - Please note that when flying in S-mode, the flight speed of the aircraft will greatly increase compared with that in N-mode (Normal). Accordingly, the braking distance will increase significantly. When flying in a windless environment, a minimum braking distance of 50 m (164 ft) is required.
 - DO NOT switch from N-mode to either S-mode or F-mode unless you are sufficiently familiar with the aircraft behavior under each flight mode. You must turn on Multiple Flight Modes in DJI Pilot 2 before switching from N-mode to other modes.
 - When switching the GNSS to the BeiDou satellite positioning system in DJI Pilot 2, the aircraft only uses a single positioning system and the satellite search capability becomes poor. Fly with caution.
 - Avoid flying in areas where GNSS signal is weak or in narrow and confined spaces. Otherwise, the aircraft will be forced to enter Attitude mode, leading to potential flight hazards. Land the aircraft in a safe place as soon as possible.
-

Calibrating the Compass

The compass may need to be calibrated after the remote controller is used in areas with electromagnetic interference. A warning prompt will appear if the compass of the remote controller requires calibration. Tap the warning prompt to start calibration. In other cases, follow the steps below to calibrate the remote controller.

1. Enter the home screen.
2. Open Settings, swipe up, and select Compass.
3. Follow the diagram on the screen to calibrate the remote controller.
4. The user will receive a prompt when the calibration is successful.



- If the remote controller compass is working normally, "Calibration Success" will be prompted after entering the calibration view. It is not necessary to perform the calibration.

HDMI Settings

The touchscreen can be shared with a display screen via an HDMI cable. The resolution can be set in Settings > Display > Advanced > HDMI.

Advanced Dual Operator Mode

M350 RTK aircraft support Advanced Dual Operator mode that allows two pilots to operate an aircraft simultaneously remote controllers A and B. In this mode, both remote controllers have equal control of the aircraft. The roles of both remote controllers operating the aircraft are not assigned in advance. Instead, either pilot may gain control of the aircraft or the gimbal camera as needed, allowing for more flexibility during the operation.

Control over the aircraft is independent of control over the gimbal camera. When a remote controller gains control of the aircraft or the gimbal camera, the user can use the controller to operate the aircraft or control the movement of the gimbal camera respectively.

Setting the Advanced Dual Operator Mode

Before using Advanced Dual Operator mode, the pilot needs to link the aircraft with both remote controllers A and B. Follow the steps below to link the remote controllers.

1. Run the DJI Pilot 2 app.
2. Enter the homepage and tap Remote Controller A/B to activate linking. During linking, the status LED of the remote controller will blink blue and the remote controller will beep. Press and hold the power button on the aircraft for at least five seconds. The aircraft power indicator will blink and beep twice to indicate that linking has started. When linking is successful, the aircraft status indicators will blink green, the remote controller beep twice, and the remote controller status LED turn solid green.
3. Thereafter, the aircraft control button on the remote controller with control of the aircraft

will turn green, and the aircraft control button of the other remote controller will turn white. Tap  on the upper right corner of the gimbal camera view in DJI Pilot 2 to gain control of the gimbal camera.

-
-  • Link the two remote controllers one by one. Make sure to link the remote controller A with the aircraft first, and then link the remote controller B.
-

Using Advanced Dual Operator Mode

1. Make sure both remote controllers are linked and connected with the aircraft before using Advanced Dual Operator mode. By default, the first remote controller connected with the aircraft is granted control of both the aircraft and the gimbal camera, while the second remote controller is not given any control.
2. When a remote controller has control of a device, whether it is the aircraft or the gimbal camera, the pilot can control the device by pushing the control sticks, turning the dial, pressing the shortcut buttons, or tapping the app's user interface. The operation is the same as in Single Operator mode. However, when a remote controller does not have control of a device, the pilot is unable to control the device. Only the remote controller with aircraft control can be used to start or cancel RTH.
3. Either pilot can take over control of a device as needed. Press the aircraft control button to gain control of the aircraft. Tap  on the upper right corner of the gimbal camera view in DJI Pilot 2 to gain control of the gimbal camera. After gaining aircraft control, the pilot can lock it by pressing and holding the aircraft authority button on the remote controller. The aircraft authority button will turn blue when the control is locked. The control sticks are used for operating the gimbal if the remote controller only has control over the gimbal camera. When the remote controller has full control, the control sticks are used for controlling the aircraft and the dials for adjusting gimbal movement.
4. In Advanced Dual Operator mode, a control transfer mechanism will be triggered if one of the remote controllers is disconnected from the aircraft. When this happens, control of the gimbal camera will shift from the disconnected remote controller to the other remote controller still connected with the aircraft. If the disconnected remote controller also has aircraft control, the other remote controller will receive a notification that the user may manually take over aircraft control. If the pilot of the connected remote controller chooses not to take over aircraft control, the aircraft will automatically perform the failsafe action. If the pilot of the connected remote controller does not choose either option within a specified time period, the aircraft will also activate the failsafe action.
5. If the disconnected remote controller reconnects with the aircraft during the flight, it will not resume its previous control and will by default have no control of any device. The pilot may gain control of the devices again as needed.
6. Only the remote controller with control of the gimbal camera can be used to adjust relevant settings for the gimbal and camera, and to download or play back media files.
7. Only the remote controller with the control over gimbal camera can perform the download and playback operations of the gimbal camera.
8. Under normal circumstances, the pilots of both remote controllers can adjust flight-related settings, such as for the flight control system, vision systems, batteries, and video

transmission. However, if aircraft control is locked, only the remote controller with aircraft control can be used to adjust these settings.

9. Remote controller A can be used to update the firmware of all modules at once when connected with the aircraft, but remote controller B can only be used to update the firmware of remote controller B.
10. Uploading Logs Using DJI Pilot 2: the pilot can upload the logs of both the aircraft and remote controller A through remote controller A, and can upload the logs of remote controller B through remote controller B.
11. The pilot of remote controller B cannot adjust settings for network RTK or custom network RTK.
12. Remote controller B cannot be used to update the GEO Zone database.
13. Other non flight-related operations can be performed using either remote controller.

Intelligent Battery Station

This chapter introduces the features of intelligent battery station.

Intelligent Battery Station

Introduction

The BS65 Intelligent Battery Station features eight TB65 battery ports, four WB37 battery ports, one USB-C maintenance port, and one USB-A and one USB-C charging port. It can charge two TB65 batteries and one WB37 battery simultaneously.

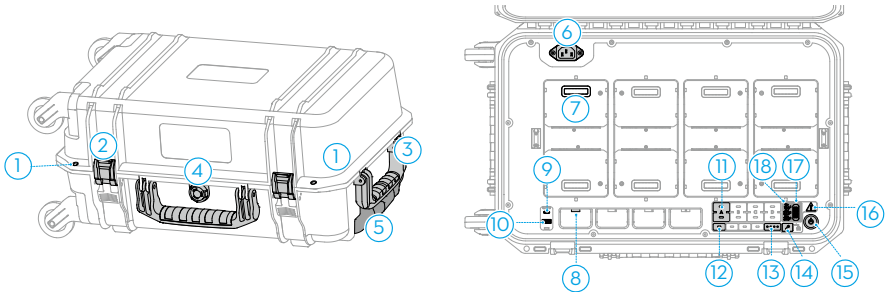

- | | | |
|-------------------------------|-------------------------|-----------------------------|
| 1. Padlock Holes | 7. TB65 Battery Port | 13. WB37 Battery Level LEDs |
| 2. Lock Clip | 8. WB37 Battery Port | 14. USB-C Maintenance Port |
| 3. Handle Bar | 9. USB-C Charging Port | 15. Power Button |
| 4. Pressure Valve | 10. USB-A Charging Port | 16. Battery Station LED |
| 5. Retractable Trolley Handle | 11. TB65 Battery LEDs | 17. Charging Mode Switch |
| 6. AC Power Port | 12. WB37 Battery LEDs | 18. Charging Mode LEDs |

Warnings

1. Keep liquids away from the inside of the battery station.
2. DO NOT close the cover of the battery station during charging. Make sure it is well-ventilated and able to dissipate heat.
3. The battery station is only compatible with the TB65 battery and WB37 battery. DO NOT use the battery station with any other battery models.
4. Place the battery station on a flat and stable surface when in use. Make sure the device is properly insulated to prevent fire hazards.
5. DO NOT attempt to touch the metal terminals in the battery station. Clean the metal terminals with a clean, dry cloth if there is any noticeable buildup after powering off.
6. Take care to avoid injuring your fingers when opening or closing the battery station.
7. Place the batteries in the specified directions.
8. Air pressure in the Battery Station may change during air transportation or after extreme barometric pressure changes. The pressure valve knob on the side of the Battery Station will balance the air pressure automatically.
9. Please use the dust blower to clear the sand and dust in the Battery Station.

Using the Battery Station

Charging

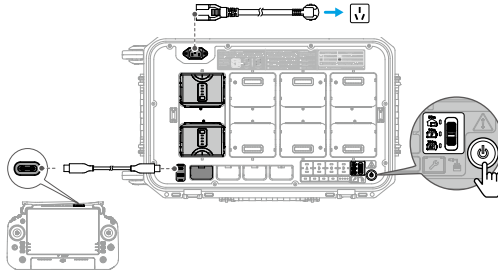



1. Connect the battery station to a power outlet using a AC power cable.
2. Press the power button once to power on the battery station.
3. Charging the TB65 batteries:
 - a. Align the orange marks on the TB65 battery and the battery port, then insert the batteries into the battery ports.
 - b. Toggle the charging mode switch to Storage Mode, Ready-to-Fly Mode, or Standard Mode.

Storage Mode  : each battery pair is charged to 50% in sequence and kept at 50% after charging. Storage Mode is good for long-term battery storage.

Ready-to-Fly Mode  : each battery pair is charged to 90% in sequence and kept at 90% after charging. Ready-to-Fly Mode facilitates quick use of batteries.

Standard Mode  : each battery pair is charged to 100% in sequence.
 - c. The battery station will charge the batteries in pairs. The pair with the highest power will be charged first.
4. Charging the WB37 batteries: insert the WB37 batteries, and the battery with the highest battery level will be charged first.
5. Charging the DJI RC Plus remote controller: connect the remote controller to the USB-C charging port using a USB-C to USB-C cable.

 • The battery station should stay powered on to maintain the battery level in Storage Mode and Ready- to-Fly Mode. Maintaining a high power level in Ready-to-Fly Mode will affect battery life. Power off the battery station after charging, except for special situations such as fire emergencies.

-
-  • Connect the remote controller to the maintenance port and run DJI Pilot 2 to view battery information, update the firmware, or diagnose the error.
- When the temperature of the TB65 battery is below 18° C (64.4° F), the batteries will be automatically warmed up after being inserted into battery station and powered on.
-

Paired Charging of Batteries

TB65 batteries should be used in pairs to extend battery life. Inserted batteries in the top and bottom ports will be automatically paired in the sequence of A, B, C, and D. The charging sequence is illustrated below:

- Between paired and a single battery, paired batteries will be charged first. (Figure a)
- When there are multiple battery pairs, the pair with the highest power will be charged first. (Figure b)
- When none of the batteries are paired, the two batteries with the highest battery level will be charged first. (Figure c)

When the power of the batteries in one pair is not the same, the battery station will charge the one with less power first, and then charge the paired batteries together once their power is the same.

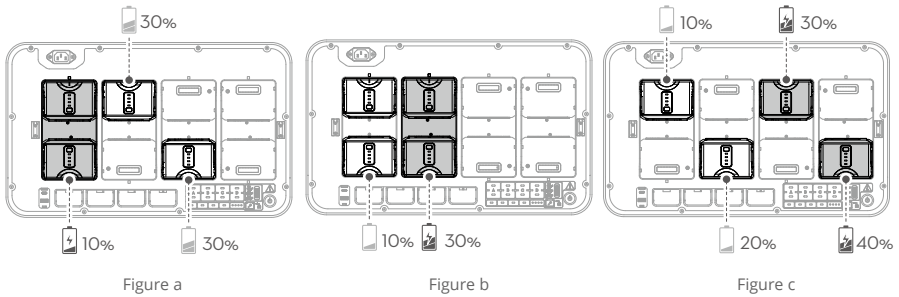

LEDs and Buzzer Description

LED Indicators	Description
Power Button	
Solid green	Powered on
Battery LEDs	
Blinks green	Charging
Solid green	Charging completed
Blinks yellow	Warming up/Cooling down
Solid yellow	Waiting to charge
Blinks red	Battery port communication error. Reinsert the battery or try another battery port.
Solid red & buzzer beeps	Battery error*
Battery Station LED	
Blinks yellow	Updating battery station firmware
Solid red & buzzer beeps	Battery station error*

* Connect the remote controller to the maintenance port, run DJI Pilot 2, and tap HMS to diagnose the error.

Specifications

Product model	BS65
Dimensions	580×358×254 mm
Net Weight	8.98 kg
Max Internal Load	12 kg
Compatible Battery Model	TB65 Intelligent Flight Battery WB37 Intelligent Battery
Input	100-120 VAC, 50-60 Hz 220-240 VAC, 50-60 Hz
Output	TB65 Battery Port: 52.8 V, 7 A×2 @100-120 V, 8.9 A×2 @220-240 V (supports up to two outputs simultaneously) WB37 Battery Port: 8.7 V, 6 A
Output Power	100-120 VAC, 750 W 220-240 VAC, 992 W
USB-C Charging Port	Max. output power of 65 W
USB-A Charging Port	Max. output power of 10 W (5 V, 2 A)
Output Power (when warming up the TB65 battery)	52.8 V, 2 A
No-load Power Consumption	< 8 W
Operating Temperature	-20° to 40° C (-4° to 104° F)
Charging Time*	Two TB65 batteries charged from 0% to 100% 100-120 V, 70 minutes 220-240 V, 60 minutes

* Charging times are tested in a lab environment at room temperature. The values provided should be used for reference only.

Intelligent Flight Battery

This chapter introduces the features of intelligent flight battery.

Intelligent Flight Battery

The TB65 intelligent flight battery is equipped with high-energy battery cells and uses an advanced battery management system to power the aircraft. Only use a DJI-approved charging device to charge the intelligent flight battery. Make sure to fully charge the intelligent flight battery before using it for the first time. The firmware for the intelligent flight battery is included in the aircraft firmware. Make sure the firmware of all intelligent flight batteries is updated to the latest version.

Battery Features

The intelligent flight battery has the following features:

1. **Battery Level Display:** the battery level LEDs display the current battery level.
2. **Charge or discharge the battery to 40% ~ 60% if NOT intended to be used for 10 days or more.** This can greatly extend the battery's overall life span. It takes approximately 6 days to discharge the battery to 60%. It is normal that you may feel moderate heat emitting from the battery during the discharge process. You can set the discharging thresholds in the DJI Pilot 2 app.
3. **Balanced Charging:** during charging, the voltages of the battery cells are automatically balanced.
4. **Overcharge Protection:** the battery stops charging automatically once fully charged.
5. **Temperature Detection:** to prevent any damage, the battery only charges when the temperature is between -20° and 45° C (-4° and 113° F).
6. **Overcurrent Protection:** the battery stops charging if an excess current is detected.
7. **Over-Discharge Protection:** during flight, to ensure flight safety and allow users to have as much time as possible to deal with emergencies, over-discharge protection is disabled to allow continuous output. Therefore, pay attention to the remaining battery level during flight and land or return to home immediately when prompted to do so in the app. Otherwise, the battery may be dangerously over-discharged. When charging, an over-discharged battery may be a fire hazard. To prevent this, the battery will be locked and can no longer be charged or used.
8. **Short Circuit Protection:** the power supply is automatically cut if a short circuit is detected.
9. **Battery Cell Damage Protection:** the app will display a warning prompt when a damaged battery cell is detected.
10. **Hibernation Mode:** the battery will be in Hibernation mode when not in use to save power.
11. **Communication:** information about the voltage, battery level, and current of the battery is transmitted to the aircraft.
12. **Heating:** the feature ensures the battery operates normally at a low temperature. Refer to the "Warming the Battery" section for details.
13. **Waterproofing and Dustproofing:** after being installed in the aircraft, the battery meets the IP55 rating standards.

- ⚠ • Refer to the user manual, safety guidelines, and battery labels before use. Users shall take full responsibility for all operations and usage.
- If only one battery is usable after takeoff, land the aircraft promptly and replace the batteries.
- Expansion ports have a built-in temperature sensor. If the payload power is too large causing the device to overheat, the aircraft will automatically cut off power supply for the payload.
- Use batteries provided by DJI. DO NOT use other batteries.

Installing the Batteries

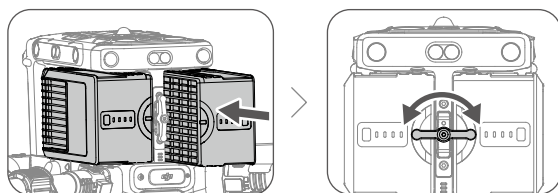

Using Paired Batteries

Label the two batteries with paired battery stickers before use. Charge and discharge the two batteries together to optimize flight performance and maximize battery life. After the batteries are inserted and the aircraft is powered on, if there is a huge difference between their battery life, the app will display a prompt alerting the user to such condition of the batteries. In this case, it is recommended to replace them with batteries with similar performance before use.

Powering On/Off

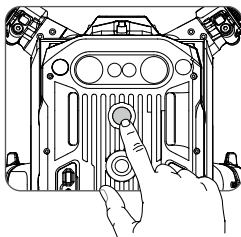

Install the batteries in the aircraft before powering on or off.

Power on/off: press the power button, then press again and hold for two seconds. The power button/indicator glows solid after the aircraft is powered on. The power button/indicator turns off after the aircraft is powered off.

Checking Battery Level

































Press the battery level button to check the current battery level when the power supply is off. After turning on the power, check the current battery level in the top bar of the app.

 The Battery Level Indicators will also show the current battery level during discharging. The indicators are defined below.

 : LED is on.

 : LED is off.

 : LED is flashing.

LED1	LED2	LED3	LED4	Battery Level
				88%~100%
				75%~87%
				63%~74%
				50%~63%
				38%~49%
				25%~37%
				13%~24%
				0%~12%

Hot Battery Replacement

After landing, the aircraft does not have to be powered off for replacement of its batteries. Insert a fully charged battery and wait for three seconds before inserting another battery.

Warming the Battery

Manual Heating: if the Intelligent Flight Battery is not installed into the aircraft, press and hold the battery level button on the battery for four seconds to initiate the self-heating, keeping the batteries at a temperature between 16° C (61° F) and 20° C (68° F), which is the ideal range of operating temperature, for approximately 30 minutes. Press and hold the battery level button for two seconds to stop heating.

Auto Heating: insert the batteries into the aircraft and power it on. If a low battery temperature is detected, the battery will automatically heat up to maintain a temperature between 16° C (61° F) and 20° C (68° F).

-  • The performance of the intelligent Flight Battery is significantly reduced when flying in low temperature environments (temperatures below 5° C). Ensure that the battery is fully charged before each flight.

- ⚠ • End the flight as soon as DJI Pilot 2 displays the Low Battery Level Warning in low temperature environments. You will still be able to control the aircraft’s movement when this warning is triggered.
- In extremely cold weather, the battery temperature may not be high enough even after warming up. In these cases, insulate the battery as required.
- To ensure optimal performance of the battery, keep the battery temperature above 16° C (61° F).
- In low temperature environments, it will take a longer time for the batteries to warm up. It is recommended to keep the battery warm before use to reduce the warm-up time.

Battery Storage

1. The battery power self-discharges to 95% for the first time after 12 hours when the battery is fully charged. The second battery self-discharge period begins from the second day by default (can be set in DJI Pilot 2) and self-discharges to 50% battery level to extend the battery life. The battery self-discharge strategy is shown below.

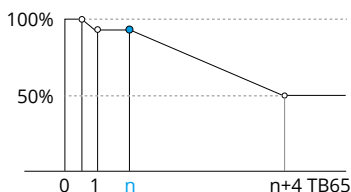

2. Storing power at proper levels can extend battery life. Use Storage Mode of the battery station to charge the power to and store it at 50%. Refer to the table below for the maximum storage days when battery power is below 50%.

Battery level	Maximum storage days	Battery level	Maximum storage days
0%	12	20%	110
5%	36	30%	160
10%	60	40%	210
15%	86	50%	260

- ⚠ • The battery will be damaged once it exceeds the maximum storage period. The battery should no longer be used.
- The actual maximum storage period will vary slightly due to the batteries being part of different production batches and stored in different environments.

Battery Maintenance

Capacity Calibration

Follow the steps to complete capacity calibration when prompted to do so by DJI Pilot 2.



Battery Maintenance

1. Battery performance will be affected if the battery is not used for an extended period.
2. Perform battery maintenance once every 50 cycles or three months or when prompted to do so by DJI Pilot 2, in the following steps:



Charge the battery fully or to the proper power level for storage after completing battery maintenance. Contact DJI Support if a maintenance failure persists.

In addition to the above, we recommend conducting the following checks for battery maintenance:

- a. Insert the battery into the aircraft and power it on to view the battery information in DJI Pilot 2. Make sure the difference in cell voltage is less than 0.1 V and the battery firmware is updated to the latest version.
- b. Make sure the battery is not swollen, leaky, or damaged.
- c. Make sure the battery terminals are clean.
- d. Regularly check the battery level and battery cycle counts. The battery is rated for 400 cycles. It is not recommended to continue to use afterward.

DJI Pilot 2 App

This chapter introduces the main functions of the DJI Pilot 2 app.

DJI Pilot 2 App

The DJI Pilot 2 app is specifically developed for enterprise users. Manual flight integrates a variety of professional features that make flying simple and intuitive. Mission flight supports flight planning and operation of the aircraft, making your workflow much simpler and more efficient.

Homepage

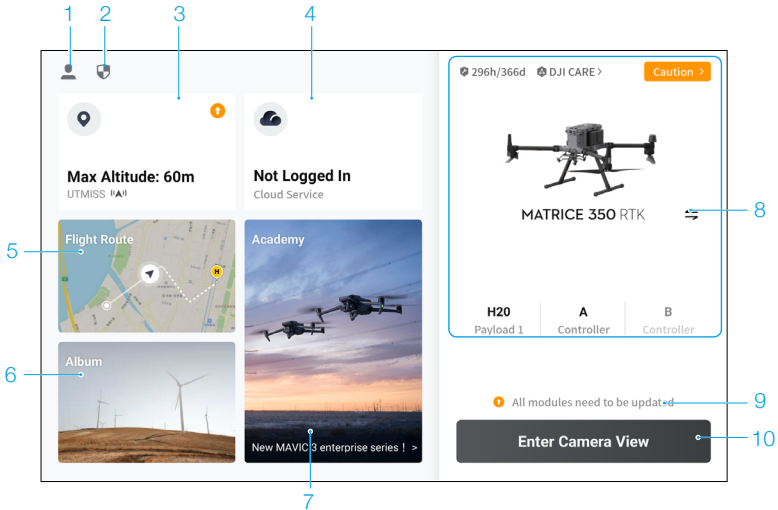

1. Me

Tap to view flight records, download offline maps, manage GEO Zone unlocking, read help documentation, select a language, and view app information.

2. Data and Privacy

Tap to manage network security modes, set security codes, manage app cache, and clear DJI device logs.

3. GEO Zone Map

Tap to view the GEO Zone map, check offline whether the current operating area is in a restricted zone or authorization zone, and the current flyable altitude.

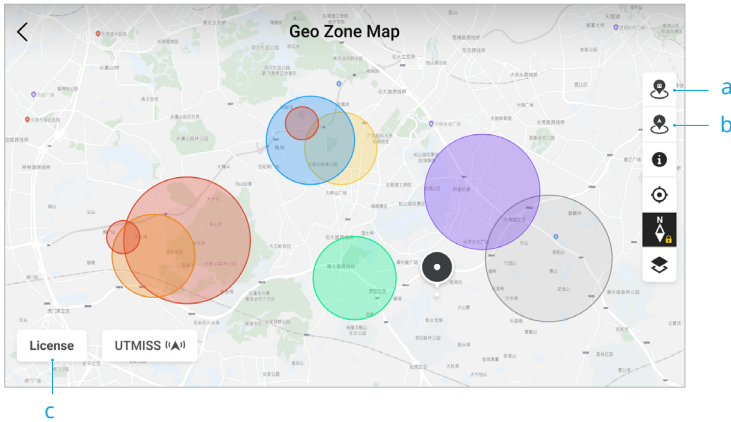

- a. Tap to update the GEO Zone database of the remote controller, if an update is available.
 - b. Tap to update the GEO Zone database of the aircraft, if an update is available.
 - c. Tap to enter and manage the unlocking certificate. If the aircraft is already connected to the remote controller, users can select the unlocking certificate directly to unlock the aircraft.
4. Cloud Service

Tap to enter the cloud service page, view the connection status of the cloud service, select the type of service, or switch from the currently connected service to another cloud service.

- a. If the DJI account logged in by the user has the DJI FlightHub 2 license, tap the cloud service on the app homepage to automatically log in to DJI FlightHub 2. DJI FlightHub 2 is a cloud-based integrated online management platform for aircraft, providing users with real-time aircraft monitoring and equipment and member management.

Visit the DJI FlightHub 2 page on the DJI official website for more information:
<https://www.dji.com/flighthub-2>

- b. If connected to the GB28181 service, GB28181 and its connection status will be displayed.
- c. If connected to a live service such as RTMP or RTSP, the corresponding live URL and connection status will be displayed.

 • If the service is connected, the font will be displayed in dark black; if it is connecting, a connecting prompt will appear in the upper right corner of the cloud service; if it is offline or disconnected, an orange icon will appear in the upper right corner of the cloud service as an abnormal alert.

5. Mission Flight

Tap to enter the mission flight library. Users can create and view all mission flights. Mission flights can be imported from and exported in batches to the remote controller or another external mobile storage device. If DJI FlightHub 2 is connected, you can also view all mission flights sent from or upload local tasks to the cloud. Refer to the Mission Flight section for more details.

6. Album

Tap to view your masterpieces all in one place. You can save the photos or videos to the remote controller. Note that photos and videos cannot be viewed if disconnected from the aircraft.

7. Academy

Tap to view enterprise product tutorials, flight guides, industry cases, and download product manuals to the remote controller.

8. Device Status

Displays the status of the aircraft, remote controller, and payload.

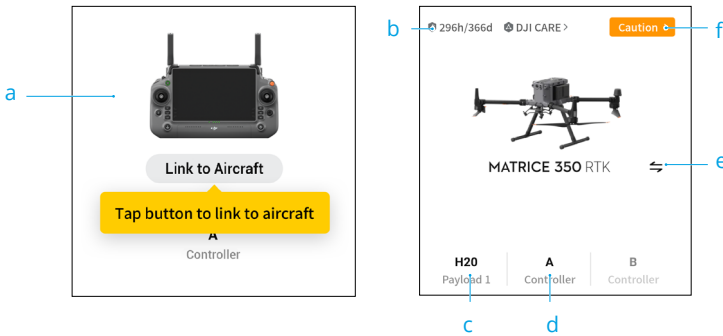

- a. If the current remote controller is not connected to the aircraft, the picture of the remote controller will be displayed. Tap to link the remote controller to the aircraft, and the aircraft model and picture will be displayed after it is connected.
- b. The maintenance information of the current aircraft is displayed here. If the aircraft has DJI Care, its validity period will also be shown. Tap to view the device information, including cycle count, flight duration, flight history, activation time, and flight mileage.
- c. If the payload is abnormal, the payload name will appear in orange or red. Tap to view the error information on the payload.
- d. The current remote controller role is displayed as A or B (the role name of the current remote controller appears in dark black). Tap to view the error information on the remote controller or switch the remote controller role.
- e. Tap to select aircraft model.
- f. Tap to enter the health management system. The health status of the aircraft and the remote controller is displayed here. If it appears in green (normal), the aircraft is normal and can take off. If in orange (caution) or red (warning), the aircraft has an error and must be checked and cleared before takeoff. Read the Health Management System (HMS) section for more details.

9. Firmware Update Shortcut

If an update is necessary, a prompt will appear notifying the user that new firmware is available or a consistent firmware update is needed for the aircraft and remote controller.

Inconsistent firmware versions will affect flight safety, therefore the app will prioritize consistent firmware updates. Tap the prompt to enter the firmware update page.

- 
 • A consistent firmware update is required when the firmware versions of some modules of the aircraft are inconsistent with the compatible version of the system. In a typical consistent firmware update situation, the aircraft and remote controller will be updated to the latest version except for extra batteries. When these batteries are used, a prompt will appear requiring a consistent firmware update to ensure flight safety.

10. Camera View

Tap to enter Preflight Check view and FPV camera view and switch to gimbal camera view. Refer to the Preflight Check View, FPV Camera View and Gimbal Camera View sections for more details.

Preflight Check View

Tap Enter Camera View on the homepage of DJI Pilot 2 to enter Preflight Check view.

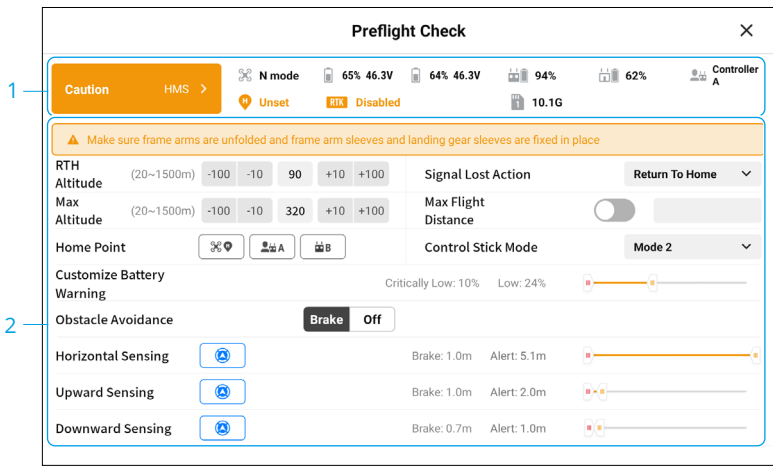

- View the aircraft's health information, flight mode, intelligent flight battery level, remote controller role, remote controller internal and external battery levels, Home Point status, RTK status, and camera microSD card storage information.
- Set the return-to-home altitude, signal lost action, maximum altitude and maximum flight distance, update the Home Point, select the control stick mode, set the battery warning threshold and obstacle avoidance.

- ☀️ It is recommended to carefully conduct the preflight check according to the operation scenario and requirements before takeoff.
- Before executing a mission flight, conduct a preflight check and verify the basic parameter information of the mission flight. Refer to the Mission Flight section for details.

FPV Camera View

Using FPV Camera View

After tapping Enter Camera View on the homepage of DJI Pilot 2 and finishing the preflight check, you will be directed to FPV camera view by default.

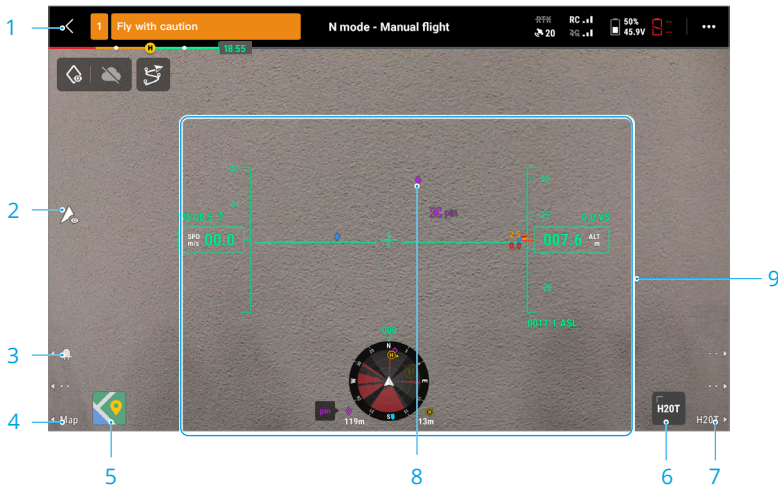

- Top Bar:** displays the aircraft status, flight mode, signal quality, etc. Refer to the Top Bar section for more details.
- Discreet Mode Switch:** tap to turn off the aircraft rear indicators and front indicators, beacons, auxiliary light, and battery indicators. After enabling Discreet Mode, the auxiliary light will not turn on during landing, which may present certain risks. Use Discreet Mode with caution.
- Beacons Switch:** press the L1 button on the remote controller to turn the beacons on or off.
- Switch to Map View:** press the L3 button on the remote controller to switch to map view.
- Map View:** Users can maximize or minimize the map. The map view supports zooming in and out.
- Gimbal Camera View:** tap to switch to gimbal camera view. The gimbal camera view supports zooming in and out.
- Switch to Gimbal Camera View:** press the R3 button on the remote controller to switch to

gimbal camera view.

- 8. **AR Projection:** projects information such as PinPoints, Waypoints, and the Home Point in FPV camera view and gimbal camera view to improve flight perception. Refer to the AR Projection section for more details.
- 9. **Primary Flight Display (PFD):** shows parameters such as attitude, speed, altitude, and wind speed during a flight. Refer to the Primary Flight Display (PFD) section for more details.

Primary Flight Display (PFD)

Primary Flight Display (PFD) makes flying easier and more intuitive, enabling users to see and avoid obstacles around the aircraft, as well as stop and adjust the flight trajectory if necessary.

Primary Flight Display may appear differently when the main view is through an FPV camera or gimbal camera (zoom camera/wide camera/thermal camera).

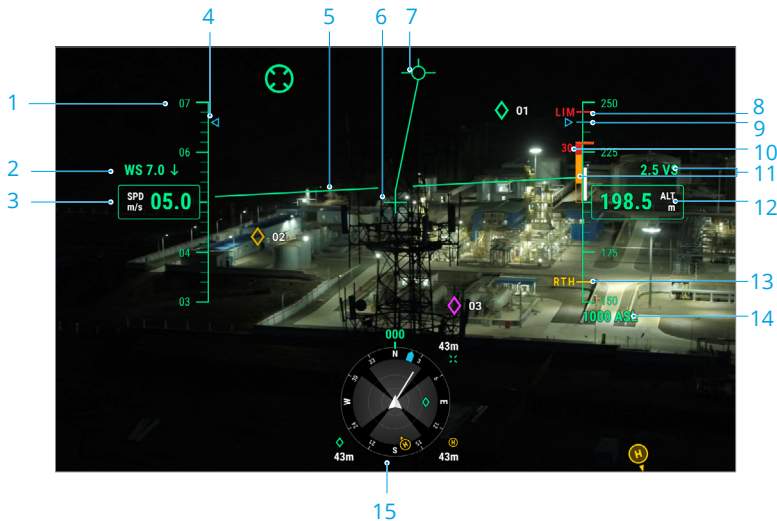

- 1. Speed wheel.
- 2. Wind speed and direction. The wind direction is relative to the aircraft.
- 3. Aircraft horizontal speed.
- 4. Preset speed of the flight route during the mission flight.
- 5. **Artificial Horizon:** reflects the attitude of the aircraft, which is opposite to its tilt angle.
- 6. **Aircraft Heading Indicator:** always in the middle of the camera view.
- 7. **Flight Path Vector:** the position the aircraft is about to reach.
- 8. **Altitude Limit (LIM):** configured by the flight controller setting.
- 9. Preset height of the flight route during the mission flight.
- 10. **Vertical Obstacle Indicator:** displays the vertical obstacle information of the aircraft. When

there is an obstacle above or below the aircraft, the information can be compared with the height of the obstacle to detect any imminent collision and avoid accidents. When upward and downward sensing are disabled, OFF will be displayed to remind the user that vertical obstacle sensing is turned off.

- Vertical Speed:** displays the vertical speed of the aircraft when ascending or descending. The white line shows the position of the aircraft in three seconds. The higher the vertical speed, the longer the white line.
- Altitude (ALT):** displays the altitude of the aircraft relative to the takeoff point.
- RTH Altitude (RTH):** displays the RTH altitude configured by the flight controller setting.
- Absolute Altitude (ASL):** displays the absolute altitude of the aircraft.
- Navigation Display:** shows the aircraft and gimbal orientation, and obstacle avoidance information from a top-down perspective. Refer to the Navigation Display section for more details.

Navigation Display

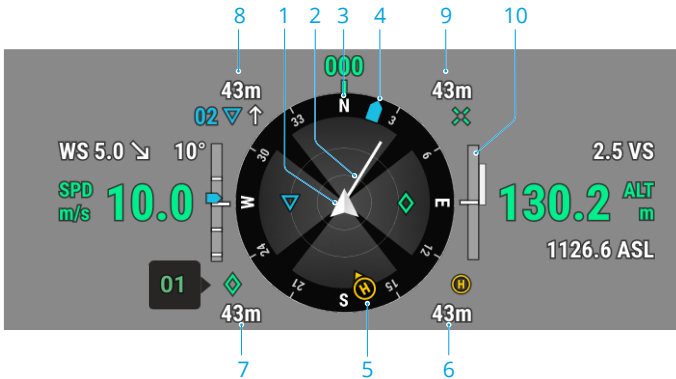

Navigation Display only shows the speed, altitude and other information on the left and right sides in gimbal camera view. In FPV camera view, such information is shown in the form of Primary Flight Display.

- Aircraft:** Navigation Display rotates with the aircraft.
- Aircraft Horizontal Speed Vector:** the white line drawn by the aircraft indicates the flight direction and speed of the aircraft.
- Aircraft Orientation:** displays the current orientation of the aircraft. The displayed degree is counted clockwise from the north, with the north assumed as 0 degrees and the step length being 30 degrees. For example, the number 24 in the compass indicates the heading of the aircraft after a 240-degree clockwise rotation from 0 degrees.
- Gimbal Orientation:** displays the orientation of the gimbal relative to the aircraft in real time. The icon rotates with the gimbal.

5. Home Point and Remote Controller Orientations:

- a. Displays the home position relative to the aircraft. When the Home Point horizontal distance exceeds 16 m, the Home Point icon will stay on the edge of the Navigation Display.
 - b. When the relative distance between the Home Point and the remote controller is no more than 5 m, only the Home Point will be displayed in Navigation Display. When the relative distance is more than 5 m, the remote controller will be displayed as a blue dot to indicate its position. When the horizontal distance between the remote controller and the aircraft exceeds 16 m, the remote controller position icon will stay on the edge of Navigation Display.
 - c. When the compass of the remote controller is working normally, the blue dot shows the direction of the remote controller. If the signal is poor during flight, point the arrow of the remote controller in Navigation Display to the direction of the aircraft.
6. **Home Point Distance:** displays the horizontal distance between the Home Point and the aircraft.
 7. **PinPoint Information:** displays the name of the PinPoint and the horizontal distance from the aircraft to the PinPoint, when PinPoint is enabled.
 8. **Waypoint Information:** displays the name of the waypoint, the horizontal distance from the aircraft to the waypoint, and the ascending or descending trajectory of the flight route, during a mission flight.
 9. **RNG Target Point Information:** displays the horizontal distance from the aircraft to the target point, when the RNG laser rangefinder is enabled.
 10. **Vertical Obstacle Sensing Information:** once an obstacle is detected in the vertical direction, an obstacle bar icon will appear. When the aircraft reaches the warning distance, the icon will glow red and orange, and the remote controller will emit long beeping sounds. When the aircraft reaches the obstacle braking distance, the icon will glow red, and the remote controller will emit short beep sounds. Both the obstacle braking distance and the warning distance can be set in DJI Pilot 2. Follow the prompted instructions in the app to set them.

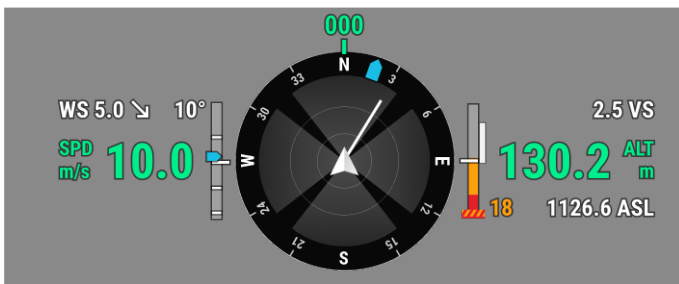

Horizontal Obstacle Sensing Information: the light areas are the obstacle sensing areas of the aircraft, while the dark areas are the blind spots. During flights, keep the aircraft speed vector line out of the obstacle-sensing blind spots.

- a. If the warning distance set in the app is from 16 m to 33 m, once an obstacle is detected, a green arc will appear in the direction of the obstacle; when the obstacle reaches the warning distance, it turns orange; when the obstacle approaches the obstacle braking distance, it changes to a red frame.



- b. If the warning distance set in the app is less than 16 m, and the obstacle is within 16 m but has not reached the warning distance, the obstacle will be indicated by a green frame; when the obstacle is within 16 m and reaches the warning distance, it turns orange; when the obstacle approaches the obstacle braking distance, it turns red.



- c. When the obstacle sensing is disabled, OFF will be displayed; when obstacle sensing is turned on, the vision systems are not working but infrared sensing systems are available, TOF will be displayed; when obstacle sensing is turned on but not working, NA will be displayed.

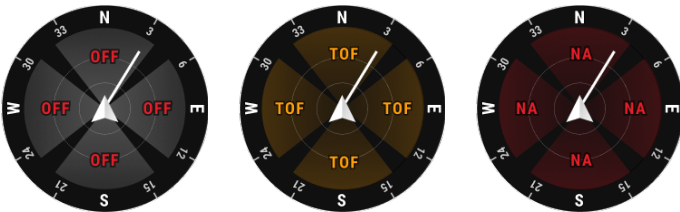

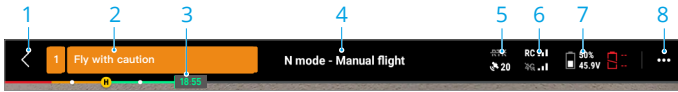

Top Bar



1. **Back:** tap to return to the homepage of the DJI Pilot 2 app.
2. **System Status Bar:** indicates the aircraft flight status and displays various warning messages. If a new alert appears during flight, it will also be displayed here and continue flashing. Tap to view the information and stop the flashing.
3. **Intelligent Flight Battery Level Indicator:** the battery level indicator bar provides a dynamic display of the remaining power of the current intelligent flight battery and the flying time. Each battery state is indicated by a different color. When the battery level is lower than the warning threshold, the battery icon on the right turns red, reminding the user to land the aircraft as soon as possible and replace the batteries.
4. **Flight Status:**
 - a. The flight statuses include: standby, preparing to take off, ready to go, manual flight, mission flight, pano in progress, Smart Track, returning to home, landing, forced landing, and vision positioning.
 - b. When the aircraft is in vision positioning, standby, or manual flight status, the current flight mode will be displayed, including: N-mode, S-mode, A-mode, and T-mode.
 - c. Tap to enter Preflight Check view.
5. **GNSS Positioning Status:** displays the number of GNSS satellites. When the aircraft RTK module is disabled, the RTK icon will turn gray; when it is enabled, the RTK icon will turn white. Tap the GNSS positioning status icon to view the status of the RTK mode and GNSS positioning.
6. **Signal Strength:** includes HD video link quality and remote controller link quality. Three green dots indicate strong signals; two yellow dots for medium signal strength; and one red dot for poor signal quality. If the signal is lost, the icon will display a disconnected status in red.
7. **Intelligent Flight Battery Level:** displays the remaining battery level of the aircraft. Tap to view battery level, voltage and temperature information.
8. **Settings:** tap to expand the settings menu to set the parameters of each module.
 - a. **Flight Control System Settings:** include flight mode switch, Home Point, return to home altitude, maximum altitude, distance limit, sensor status, signal lost action, center of gravity auto calibration, coordinated turn, and GNSS.
 - b. **Sensing System Settings:** include obstacle sensing switch, vision positioning switch, and precision landing switch.
 - c. **Remote Controller Settings:** include stick mode, customizable button settings, and remote controller calibration and linking.
 - d. **Video Transmission Settings:** include work frequency, channel mode, and video output type.
 - e. **Intelligent Flight Battery Settings:** include battery information, smart return-to-home,

low battery warning thresholds, and number of days required for self-discharge.

- f.  **Gimbal Settings:** include gimbal pitch and pan settings, and gimbal auto calibration.
- g.  **RTK Settings:** include the RTK positioning function, RTK service type, and their corresponding settings and status displays.
- h. **General Settings:** include map selection, track display, unit setting, and lights setting.

AR Projection

DJI Pilot 2 App supports AR projection, including:

- a. **Home Point:** when the Home Point is beyond the current view, it will be displayed on the edge of the view. The aircraft can be turned towards the Home Point by following the arrow.
- b. **PinPoints:** a PinPoint appears bigger when near the aircraft and smaller when it is far. This allows users to judge the distance between the PinPoint and the aircraft from the size of the PinPoint. When a PinPoint selected is beyond the current view, it will be displayed on the edge of the view. The aircraft can be turned towards the PinPoint by following the arrow.
- c. **Waypoints:** in a mission flight, the two waypoints the aircraft is about to reach will be projected on FPV camera view or gimbal camera view. The next waypoint to be reached will appear as a solid triangle and a serial number; while the subsequent waypoint will appear as a dotted triangle and a serial number.
- d. **ADS-B Manned Airplane:** when a manned airplane is detected close by, it will be projected on FPV camera view and gimbal camera view. Ascend or descend the aircraft as soon as possible to avoid the manned airplane by following the prompted instructions.

Gimbal Camera View

Using Gimbal Camera View

Gimbal camera view will appear when you switch the main view to the gimbal camera. Below is an illustration using the zoom camera as the main view.



- Navigation Display:** refer to the Navigation Display section for details. Note that in gimbal camera view, the horizontal speed, wind speed, gimbal pitch angle and pitch scale, and the inclination of the gimbal relative to the ground are shown on the left side. When the gimbal is at a key angle such as -90° , 0° , or -45° , the number will be highlighted. The right side of Navigation Display shows the altitude, relative altitude, vertical obstacle sensing information, and vertical speed bar.
- Camera Type:** displays the camera type for the current main view.
- Camera Parameters:** displays the camera's current shoot/record parameters.
- Auto Exposure Lock:** tap to lock the current exposure value.
- Focus Mode:** tap to switch the focus mode, between MF (manual focus), AFC (continuous autofocus) and AFS (single autofocus).
- Storage Mode:** displays the remaining photo number or the video duration video of the microSD card. Tap to check the remaining capacity of the storage and select the storage format.
- Switch to Auto/Manual Exposure:** the zoom camera supports Auto and M modes. The EV can be set in Auto mode, and the ISO and shutter can be set in M mode.
- Camera Settings:** tap to enter the camera setting menu. The camera setting menu may vary by camera type. Select a camera type to view its parameters.
- Photo/Video Toggle:** tap to switch between photo and video modes, and select different shooting or recording modes.

- a. The photo modes include single, timed, High-Res Grid shooting, panorama, etc. The options vary according to the gimbal camera model.
 - b. Various resolutions can be selected in video recording mode. The options vary according to the gimbal camera model.
10. **Shoot/Record Button:** tap to take a photo or start or stop recording.
 11. **Playback:** tap to enter the album to view and download photos/videos stored in the aircraft's microSD card.
 12. **Link Zoom:** tap to link the lenses of the thermal camera and zoom camera to zoom. The user can view the linked zoom effect by enabling the SBS button in the thermal camera view. Only H20N supports link zoom.
 13. Press the R1 button on the remote controller, and the camera lens will zoom in.
 14. Press the R2 button on the remote controller, and the camera lens will zoom out.
 15. Press the R3 button on the remote controller to switch to FPV Camera View.
 16. **FPV Camera View:** tap to switch to FPV camera view. The FPV camera view supports zooming in and out.
 17. **Map View:** tap to switch to map view. The map view supports zooming in and out.
 18. **PinPoint:** press the L3 button on the remote controller to add a PinPoint in the center of the screen. Press and hold on the L3 button to expand the PinPoint settings panel, which allows you to set the PinPoint color, view all target points, or enable the default display of target points in video transmission view. Refer to the PinPoint section for more details.
 19. **Switch to Wide/Zoom Camera Lens:** press the L2 button on the remote controller to switch between the wide-angle camera lens and the zoom camera lens.
 20. **Switch to Visible Light/Thermal Camera Lens:** press the L1 button on the remote controller to switch between the visible light camera lens (wide-angle camera or zoom camera) and the thermal camera lens.
 21. **Gimbal Mode:** displays the current gimbal status as follow mode. Tap to select an action such as gimbal recenter, gimbal pan recenter, gimbal tilt down, or gimbal down, or switch to gimbal free mode.
 22. **Smart Track:** the aircraft's gimbal camera can track the target (person/vehicle/boat) when Smart Track is enabled. Refer to the Smart Track section for more details.
 23. **RNG Laser Rangefinder:** the straight-line distance between the aircraft and the target, as well as the height of the target can be measured using the RNG Laser Rangefinder. Refer to the RNG Laser Rangefinder section for more details.
 24. **Look At:** after selecting a PinPoint, the user can tap the Look At icon to rotate the gimbal, allowing the camera to look at the target.
 25. **Status of Photo/Video Upload to Cloud:** displays the status of a photo/video upload from DJI Pilot 2 to DJI FlightHub 2 or the connection status of a live stream; tap to view the details. If you are using the DJI FlightHub 2 cloud service, you can quickly configure its media file upload settings.



26. **Mission Flight Control/Status:** displays the progress of a mission flight in gimbal camera view. Tap the Pause/Resume button to pause/resume the task, and tap the panel to view the mission flight name and actions.



Wide Camera View

This section mainly sets out the differences with zoom camera. Refer to the Gimbal Camera View section for more details.

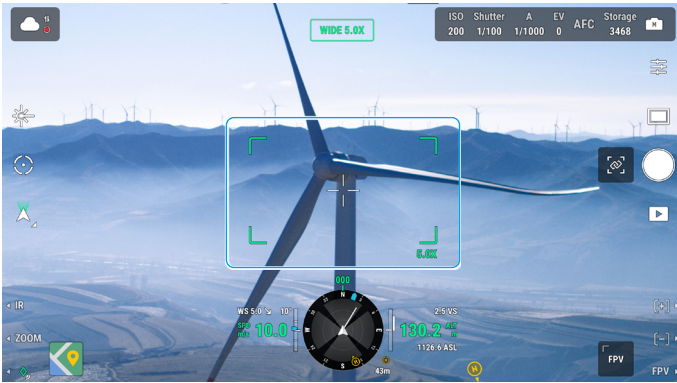

Zoom Frame: After switching to a wide-angle camera as the main view, the zoom frame will display the field of view and camera zoom rate.

Thermal Camera View

This section mainly sets out the differences with zoom camera. Refer to the Gimbal Camera View section for more details.



1. **Palette/Isotherm:** displays the highest and lowest temperature measurement values of the current view. Tap to choose between different infrared temperature measurement palettes, or enable the isotherm to set temperature measurement intervals. Note that if the measured area exceeds the maximum or minimum temperature measurement values of the current view, the setting will not take effect.
2. **Gain Modes:** high gain mode provides more accurate temperature measurements with a measurement range from -20° to 150 ° C, while low gain mode supports a wider temperature measurement range of 0° to 500° C. Note that the range is only a theoretical value, and even though the thermal camera can measure temperatures beyond the range, the value may deviate substantially.
3. **Display Mode:** the infrared screen is set as single infrared view by default. Tap to enable or disable side-by-side view. When enabled, both the footage captured by the infrared thermal camera and the zoom camera will be displayed side by side.
4. **FFC Calibration:** tap to execute FFC calibration. FFC calibration is a function of the infrared thermal camera that optimizes image quality for easy observation of temperature changes.
5. **Zoom (Thermal Camera):** tap to adjust the digital zoom of the infrared thermal camera with a maximum zoom capability of 20x. Tap and hold to zoom directly to 2x.

Laser Rangefinder (RNG)



1. Tap to enable the RNG.
2. The cross hair in the center of the lens will turn red, which means the laser rangefinder is aiming at the target and measuring the altitude of the target and distance between the target and the aircraft. The latitude and the longitude of the target can be obtained after a PinPoint is created on the target.
3. The linear distance between the target and the aircraft.
4. The altitude between the target and the aircraft.

- The latitude and longitude of the target.
- The horizontal distance between the target and the aircraft.

- ☀️ • RNG positioning is limited by factors such as the GNSS positioning accuracy and gimbal attitude accuracy. The GNSS position, horizontal distance, Navigation Display, and AR projection are provided for reference only.
- When the zoom camera is aiming, the cross hairs will be an upright cross, while with the wide-angle camera or thermal camera it will turn into an X.

Smart Track

Introduction

When operating the H20 series gimbal camera, the pilot can use Smart Track to identify, lock and track targets such as people, vehicles, boats, or other objects. After recognizing and locking the target, it will automatically rotate the gimbal to situate the target in the center of the screen, and adjust the camera focal length to an appropriate focus rate to track and view the target.

- ☀️ • When the tracked target is set to objects, the tracking effect will be limited.
- ⚠️ • Use Smart Track in an open environment to avoid blocking the target.
- When the aircraft is returning to the Home Point, landing or set to T-mode, Smart Track will be disabled. The device will exit Smart Track immediately in any of the above situations.

Identifying and Locking a Target

Smart Track can be enabled after entering zoom view in the app.



- Tap to start or stop Smart Track.
- The feature identifies a person, vehicle, or boat as the target. Alternatively, you can gesture on the screen to select another object as the target.

- ☀️ • When Smart Track is enabled, a tracking frame will appear and select the target, and the cross hairs in the center of the zoom lens will turn green, indicating that tracking is in progress. If no target is confirmed, the tracking frame will not appear and the app will display the message "Searching for targets ...". If the target is blocked or lost, the device will predict and search for the trajectory of the target until it is reacquired before resuming the tracking. Otherwise, the device will quit Smart Track.

- ⚠️ • If the user is selecting other types of targets by gesturing on the screen, any person, vehicle or boat that appears in the frame will be selected as the target and tracked.
 - An object cannot be selected using gestures if the features of the object are not clear.

Tracking a Target

The gimbal mode will default to follow mode, and the camera will default to AFC mode when Smart Track is enabled.

In gimbal follow mode, the orientation of the aircraft is always consistent with that of the gimbal, both aiming at the target. The attitude of the gimbal will be adjusted automatically to situate the target in the center, while the camera will adjust its zoom to re-size the target. The user can fine-tune the size of the target in the field of view using the right dial of the remote controller.

Target Prediction: if a target is lost, the device will predict the motion trajectory and the gimbal will rotate automatically to search for the target.

Target Search: if the target is lost, the device will automatically search for its based on its predicted position. The user can also manually control the gimbal rotation and camera zoom to find the target.

Target Positioning: the GNSS position of the target will be displayed in the navigation display and map (note that when the laser rangefinder of the H20N or the H20 series gimbal and camera continues to be invalid, the target position is for reference only), the position of the target will also be displayed in the FPV view.

Focus Tracking: the camera focus will be adjusted according to the distance of the target object.

In gimbal follow mode, "Smart Track" will be displayed on the top bar during tracking. The control mode of the aircraft is slightly different from its normal flight mode. Make sure you are familiar with the following controls and fly with caution.

Operation on Remote Controller	Action Performed	Reminders
Pressing and holding the Pause button	Exits Smart Track.	/
Yaw stick	Adjusts yaw movement of gimbal	The adjustable range is limited during tracking.

Pitch stick	Flies the aircraft toward or away from the target horizontally. The maximum flight speed is less than 17 m/s. Continue operating the stick to keep tracking the target.	When it is close to the target horizontally, the aircraft's speed in the direction close to the target will be limited. The aircraft cannot approach the target in the following condition: <ul style="list-style-type: none"> • The aircraft is less than 5 m from the target. • The target is under the aircraft that the gimbal tilt needs to be greater than 80°.
Roll stick	The aircraft circles the target horizontally. The maximum flight speed is less than 17 m/s.	When it is close to the target horizontally, the aircraft's orbiting speed will be limited.
Throttle stick	Controls the aircraft altitude	/
Left dial	Adjusts the gimbal tilt	The adjustable range is limited during tracking.
Right dial	Adjusts the camera zoom	The adjustable range is limited during tracking.
Switch to T-mode	Exit Smart Track.	/

 • To ensure optimal shooting of moving targets, taking photos during target tracking will not lock the gimbal. Motion blur may occur due to a static background.

 • Poor recognition or tracking effect may occur in the below scenes:

- a. Recognition may decline at night.
- b. The tracking effect may decline when the payload is working at high magnification.
- c. The tracking effect may decline in environments with poor visibility such as in a rain, fog, or haze.
- d. The tracked object/target may change in scenes with heavy traffic, crowds, or large clusters of similar objects.

Map View

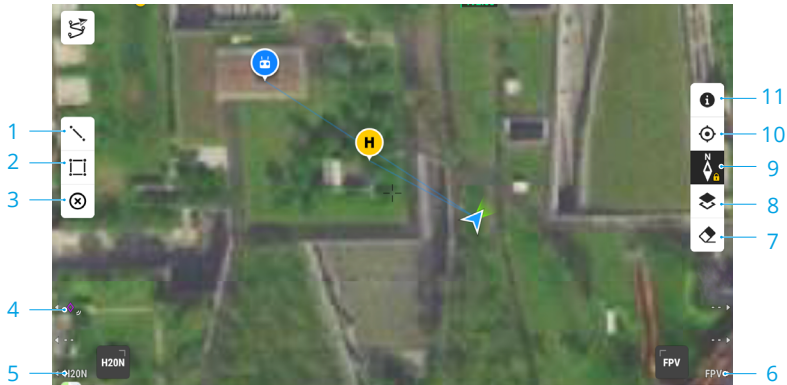

1. Tap to draw lines on the map.
2. Tap to draw an area on the map.
3. Tap to clear all points, lines, and annotations on the current view. If the user is logged in on DJI FlightHub 2, the icon is not shown.
4. **PinPoint:** press the L1 button on the remote controller to add a PinPoint in the center of the view. Press and hold on the L1 button to expand the PinPoint settings panel, which allows users to change the PinPoint color, view all target points, or set the default display of the target point in video transmission view.
5. **Switch to FPV Camera View:** press the L3 button on the remote controller to switch to FPV camera view.
6. **Switch to Gimbal Camera View:** press the R3 button on the remote controller to switch to gimbal camera view.
7. Tap to clear the flight track of the aircraft.
8. **Map Layer Selection:** tap to select a satellite or street map (standard mode) according to operation requirements.
9. **Map Lock:** if enabled, the map cannot be rotated; if disabled, the map can rotate freely.
10. **Recenter Button:** tap to quickly center the remote controller in the view.
11. **GEO Zone Layer Management:** tap to view all GEO Zone layer information and enable or disable the GEO Zone layer.

Annotation Management and Synchronization

PinPoint

Introduction to PinPoint

PinPoint is available when using the H20 series gimbal camera. PinPoint can be used to set the location point of a target in gimbal camera view or map view, for quick observation and information synchronization.



- Steps to Create a PinPoint:** adjust the attitude of the aircraft and the gimbal to move the target to the center of the current view. Press the L3 button of the remote controller to pin the target at the center. The PinPoint can record the latitude, longitude and altitude of the target.
- AR projection will be created for the target in gimbal camera view or FPV camera view. It will become larger or smaller according to the distance between the aircraft and the PinPoint (big when near, small when far).
- Selected PinPoint:**
 - A small frame will appear around the PinPoint indicating it is selected.
 - The lower left corner of Navigation Display shows the horizontal distance from the target to the aircraft and the name of the point. The orientation of the point relative to the aircraft is shown within Navigation Display.
 - If the selected PinPoint is outside the video transmission view, the PinPoint icon will stay on the edge indicating the its orientation relative to the center of the view.
 - After selecting a PinPoint, the user can edit the name, color, latitude, longitude, and altitude of the target point, or drag the PinPoint on the map.
- Tap **⋮** and tap **🗑️** to change the custom remote controller settings to PinPoint, delete the

selected PinPoint, or select the previous or next PinPoint. Users can quickly generate and select PinPoints by using the buttons.

- 5. Tap to switch to map view:
 - a. The PinPoint and its name will be displayed on the map accordingly.
 - b. In map view, you can also set a PinPoint by tapping the target. The point is at the cross hairs in the center of the map, and the altitude is the current flight altitude of the aircraft.
 - c. Tap to select a PinPoint on the map to view the creator of the point, the distance between the target point and the aircraft, the altitude, latitude and longitude of the target point, or set the PinPoint as the Home Point, or edit or delete the PinPoint.

 • PinPoint positioning is limited by factors such as the GNSS positioning accuracy and gimbal attitude accuracy. The latitude and longitude, horizontal distance, Navigation Display, and AR projection are provided for reference only.

Editing PinPoints

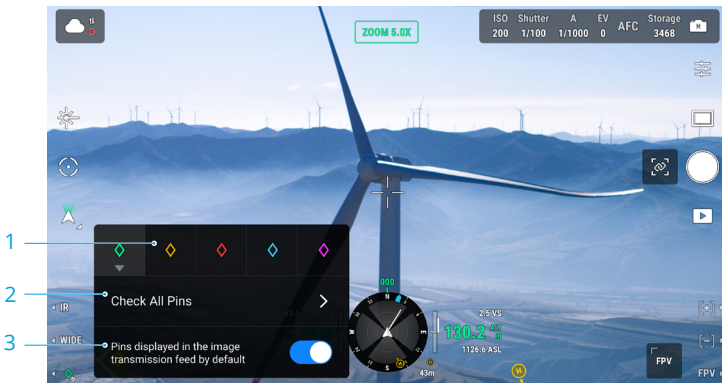

- 1. Press and hold the L3 button on the remote controller to bring up the settings panel of the PinPoint. There are five color options for the PinPoint, and it is recommended to set a color for each type of target as required by the operation scenario.
- 2. Tap to expand the PinPoint list to view all the target points.
- 3. Set whether to display the newly created PinPoint in video transmission view.

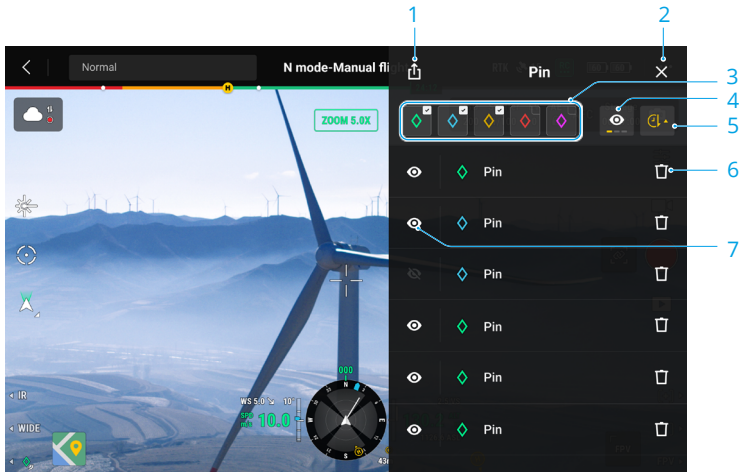

1. Tap to export all PinPoints to the local folder of the remote controller.
2. Tap to close the current panel.
3. Filter the PinPoints by color. After a color is selected, it is displaying PinPoints of this color.
4. Filter the PinPoints by their visibility in video transmission view. The PinPoints can be filtered by any of these three criteria: show all PinPoints on this list; only show PinPoints that are visible in video transmission view on this list; only show PinPoints that are not visible in video transmission view on this list.
5. Tap to sort PinPoints in forward or reverse chronological order, or in alphabetical order by their names.
6. Tap to delete the PinPoint.
7. Tap to enable or disable AR projection display for the PinPoint in video transmission view.

Line and Area Annotation Management

Users can draw lines and areas on the map for synchronizing key information of roads and land.

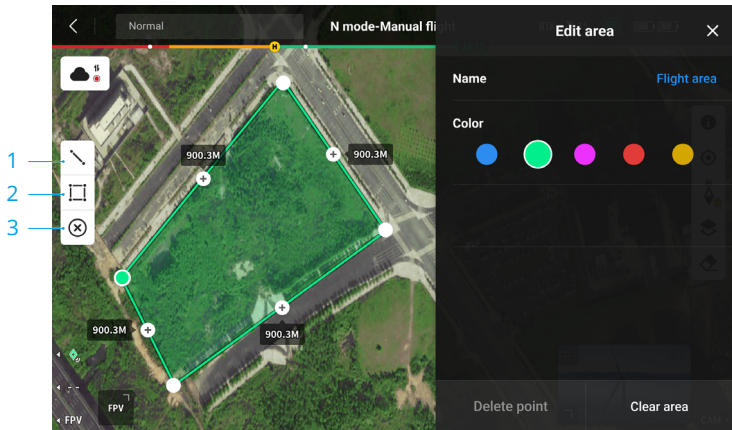
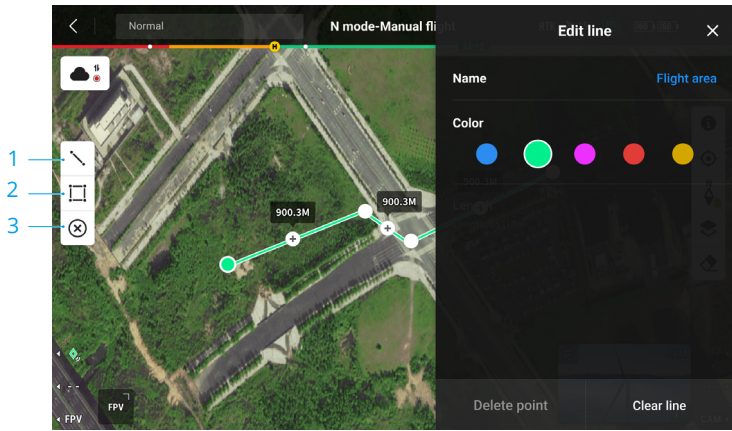

1. Tap to display the Edit Line view.
2. Tap to display the Edit Area view.
3. All the point, line and area information can be viewed on the map. Tap this icon to delete the information.

Annotation Sharing

The location of the target point identified by PinPoint can be synchronized with camera view, Navigation Display, map view, and DJI FlightHub 2 for sharing of location information. It can be displayed on both video transmission view and map view.



In Advanced Dual Operator mode, all point, line and area annotations can be synchronized with another remote controller.

When connected to DJI FlightHub 2, the DJI Pilot 2 app and the point, line and area annotations of DJI FlightHub 2 can be synchronized with each other. They can be viewed on the remote controller and other devices logged into DJI FlightHub 2 for real-time sharing of locations and annotations.

Mission Flight

Tap on the homepage of DJI Pilot 2 to enter the mission library. The user can view created mission flight routes, or newly created Waypoint, Mapping, Oblique, or Linear Flight missions. The above four types of missions are generated by the app; Waypoint flights can also be created through Live Mission Recording.



Mission Flight Introduction

The mission flight function is illustrated below with Waypoint flights as an example.

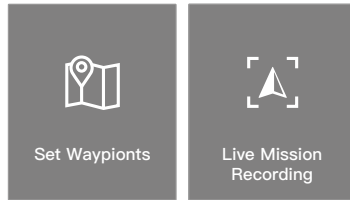

Waypoint flights can be planned in of two ways: set Waypoints and Live Mission Recording. Use Set Waypoints to create a route by adding editable waypoints on the map. Use Live Mission Recording to create a route by adding waypoints and editing the target in photos captured along the route.

Mission Flight - Setting Waypoints

Tap Create a Route, Waypoint flight, and then Set Waypoints to create a new flight route. Tap on the map to add waypoints, then configure route and waypoint settings.

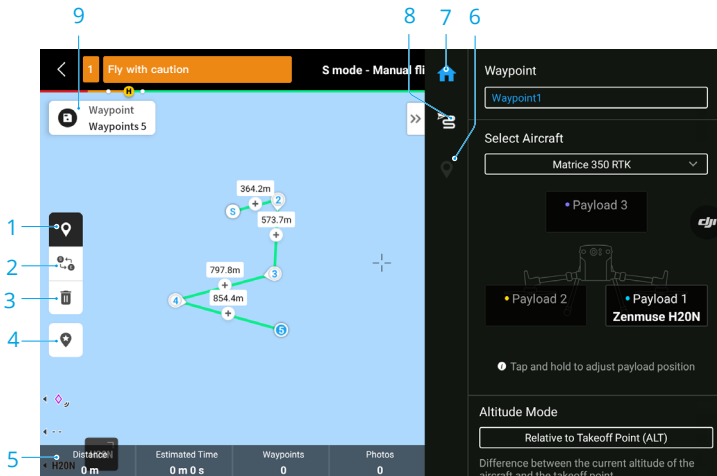

1. Enable or disable waypoint settings.
2. **Reverse Path:** tap to swap the start and end points to reverse the flight path. S refers to the start point.
3. **Delete Selected Waypoint:** tap to delete the selected waypoint.
4. **Point of Interest (POI):** tap to enable the POI function and a POI will be displayed on the

map. Drag to adjust its position. After a POI is added, the aircraft yaw can be set as facing the POI so that the aircraft nose points at the POI point during the mission. Tap this icon again to disable the POI function.

5. **Flight Route Information:** displays the flight length, estimated flight time, waypoint quantity, photo quantity.
6. **Set Individual Waypoints:** select a waypoint and set its parameters. Tap < or > to switch to the previous or next waypoint. The settings are applied to the selected waypoint, including aircraft speed, aircraft altitude, aircraft yaw mode, waypoint type, aircraft rotation, gimbal tilt, waypoint actions, longitude and latitude.
7. **Parameters List:** edit the route name, advance flight route settings and altitude mode, and set the aircraft type.
8. **Route Settings:** the settings are applied to the entire route, including safe takeoff altitude, ascend to start point, aircraft speed, aircraft altitude, aircraft yaw, gimbal control, waypoint type, and completion action. These parameters will take effect for all waypoints in the route.
9. **Save:** tap to save the flight route. After the flight route is saved, the icon becomes the perform task button, tap the button and then check the settings and status of the aircraft in the pop-up checklist. Tap to upload the flight route. Once the upload is complete, tap the Start button to perform the current task.

Mission Flight - Live Mission Recording

Tap Create a Route, Waypoint Flight, and Live Mission Recording to record information on the photos captured or aircraft position for the waypoint.



1. Control the gimbal, adjust the camera zoom and aim at the target, and tap to capture a photo directly or press the C1 on the remote controller to set a waypoint. The waypoint and photo quantity will increase accordingly.
2. The number of planned waypoints.

- 3. The number of planned photos.
- 4. Tap to switch to map view for editing or viewing.

AI Spot-Check

When pairing the M350 RTK with the H20 series payload, AI Spot-Check is available. In AI Spot-Check page, you can switch from different photos, drag-select photos and adjust the size. When the route is executed, the selected object will be accurately photographed.

- a. Back.
- b. Displays the waypoint number and the photo number.
- c. Displays the gimbal and lens of the photo.
- d. Photo thumbnails, tap to select the photo that needs to be edited accurately. The photo has been edited by AI Spot-Check, and is marked with +.
- e. Gesture to select the object in the photo, adjust the selection box size, drag or delete the selection box, and the selection box will follow the picture so as to enlarge or reduce. Tap once on the picture to hide / show other buttons and tools on the screen.
- f. Tap to save the flight route settings and the AI Spot-Check configurations, and a flight route is created.

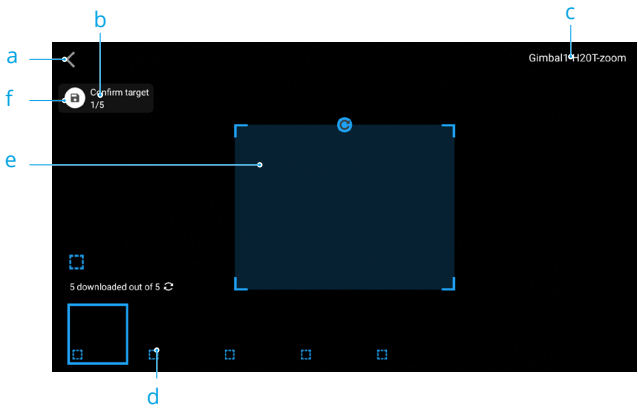

- ⚠️ • AI Spot-Check can only be used with the H20 series payload in zoom camera view.
- AI Spot-Check takes photos at up to 10 times the focal length.
- RTK should be used for photo capture and Planned Route flight of the AI Spot-Check, and the RTK base station coordinates of the photo capture and Planned Route flight must be the same.
- AI Spot-Check can support up to 750 photos.
- The ratio of the selection box size of the photo to the area of the whole photo cannot be less than 1/25 when using AI Spot-Check.
- The selection box position must be in the middle of the view and the size needs to be the same as the target size.
- If Advanced Dual Operator Mode is in use, Controller A must be used to complete the Demo Flight and mission upload.
- H20 and H20T gimbal and camera should be installed on the 1st gimbal port.

In-Flight Editing

Enter the mission library, select a created flight route for editing or viewing.

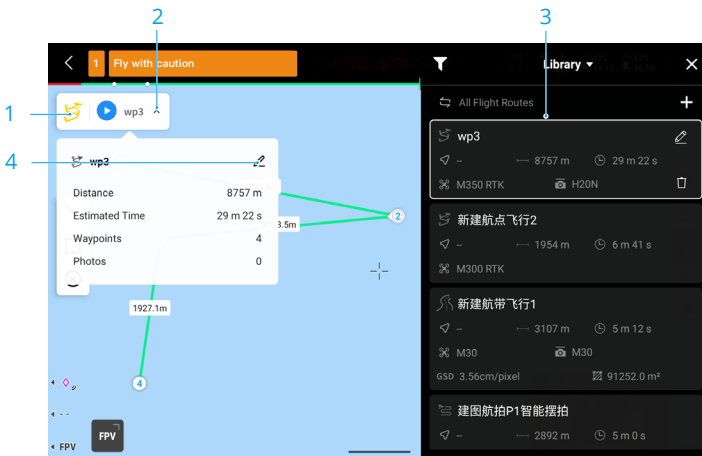

1. Tap to view the Library.
2. Select a flight route to preview.
3. Tap to view the flight route settings.
4. Tap to edit the flight route.

Health Management System (HMS)

The HMS system includes the DJI Maintenance Program, DJI Care Enterprise, Firmware Update, Manage Logs, Error Records, and Error Diagnosis.

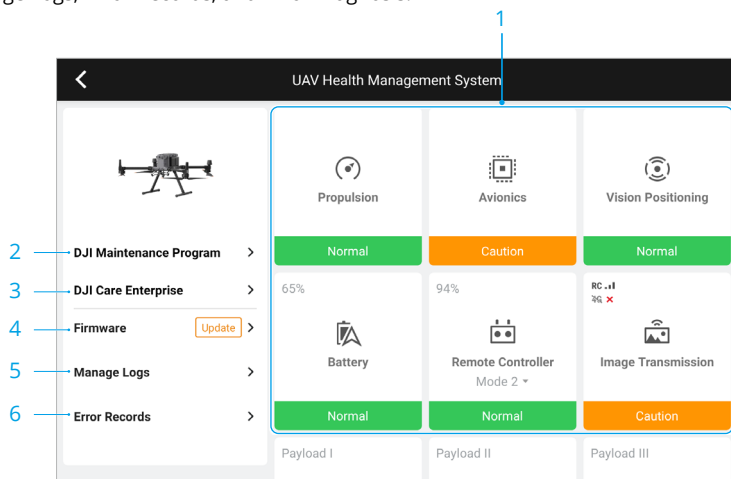

- Error Diagnosis:** for checking the current health status of each module of the aircraft. Users can solve errors by following the relevant prompted instructions.

Color	Status
Green	Normal
Orange	Caution
Red	Warning

- DJI Maintenance Program:** users can view historical flight data and refer to the maintenance manual to determine if maintenance is required.
- DJI Care:** relevant information can be viewed if the device is bound to DJI Care.
- Firmware Update:** tap to enter the Firmware Update view.
- Manage Logs:** displays the remote controller and aircraft log data of recent sorties. The user can assist by extracting the relevant logs to local storage or upload them directly to the DJI Support cloud, to facilitate troubleshooting by DJI Support.
- Error Records:** records of aircraft historical for determining if any serious problem has occurred during aircraft operation. This helps users evaluate the stability of the aircraft and assists DJI Support in conducting after-sales analysis.

-  Error Records are available for the batteries and battery station (the battery station must be connected to the remote controller via the USB-C cable).
- Manage Logs is available for the batteries and battery station (the battery station must be connected to the remote controller via the USB-C cable).

Intelligent Battery Station Management

To check the status of the battery station on the HMS page via DJI Pilot 2, connect the battery station to the remote controller using a USB-C cable. The version and warning information of the battery station and the battery can be viewed on the HMS page, and supports self-discharging settings and exporting the log. Tap the firmware update icon to update the firmware of the battery station and the battery.

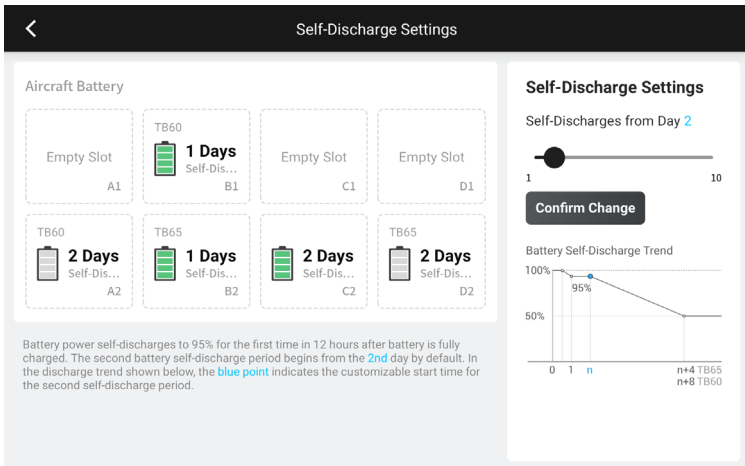

DJI FlightHub 2

Paired with the DJI FlightHub 2 cloud platform, the M350 RTK offers integrated air and ground handling with efficient operation management. The combined features of the two products makes a wide range of real-time operations possible, including cloud mapping, point, line, and area annotation, flight information syncing, live viewing, media file upload or download, mutual access to statuses of multiple aircraft, mission flight syncing, and real-time control from mobile devices.

For more details, refer to the DJI FlightHub 2 User Guide which is available to download from the official DJI website <https://www.dji.com/flighthub-2/downloads>.

Firmware Update

This chapter introduces the methods of updating the firmware of the device.

Firmware Update

Use DJI Pilot 2 or DJI Assistant 2 (Enterprise Series) to update the remote controller, aircraft and other connected DJI devices.

Using DJI Pilot 2

Aircraft and Remote Controller Firmware Update

1. Power on the aircraft and remote controller. Ensure the aircraft is properly linked to the remote controller, their battery levels are higher than 25%, and the remote controller is connected to the internet.
2. Run DJI Pilot 2. A prompt will appear on the homepage if new firmware is available. Tap to enter the Firmware Update view.
3. Tap Update All and DJI Pilot 2 will download the firmware and update the aircraft and remote controller.
4. The aircraft and remote controller will automatically restart after the firmware update is completed.



- The update takes approximately 15 minutes (depending on network strength). Make sure the remote controller is connected to the internet during the whole update process.
 - The TB65 intelligent flight batteries, DJI CSM Radar and gimbal camera installed on the aircraft will be updated to the latest firmware version.
-

Battery Station and TB65 Batteries Firmware Update

Use the DJI Pilot 2 app to update the firmware of the battery station as well as up to eight TB65 flight batteries at the same time.

1. Insert the TB65 batteries into the battery port and power on the battery station.
2. Connect the battery station USB-C maintenance port to the remote controller USB-C port using a USB-C cable.
3. Power on the remote controller and make sure it is connected to the internet.
4. Run DJI Pilot 2. If a version update is available, the homepage will prompt that the battery station firmware update is required. Tap to enter the battery station update page.
5. Tap the Update All button to begin the update, which takes approximately 10 minutes. The update is completed when the update success prompt appears.



- During a firmware update, DO NOT insert or remove the batteries to avoid battery update failure.
 - During a firmware update, DO NOT unplug the USB-C cable to avoid firmware update failure.
-

Offline Update

An offline firmware package can be downloaded from the DJI official website to an external storage device such as a microSD card or U disk. Run DJI Pilot 2, tap HMS, and then Firmware Update. Tap Offline Update to select the firmware package of the remote controller, aircraft, or battery station from the external storage device and tap Update All to update.

Using DJI Assistant 2 (Enterprise Series)

DJI Assistant 2 (Enterprise Series) supports the updating of the aircraft, remote controller and the Zenmuse H20/H20T gimbal cameras but not the BS65 battery station and the Zenmuse H20N/L1/L2/P1 gimbal cameras.

Aircraft and Remote Controller Firmware Update

1. Connect the remote controller or aircraft to the PC one by one, as the DJI Assistant 2 does not support the updating of multiple DJI devices at the same time.
2. Make sure the PC is connected to the internet and the DJI device is powered on with a battery level higher than 25%.
3. Run the DJI Assistant 2, log in with your DJI account and enter the main interface.
4. Tap the firmware update button on the left side of the main interface.
5. Select the firmware version and tap to update. The assistant software will download and update the firmware automatically.
6. When the "Update successful" prompt appears, the device update is completed, and the DJI device will restart automatically.

Zenmuse H20/H20T Firmware Update

1. Install the Zenmuse H20/H20T payload onto the aircraft. Power on the aircraft. Connect the aircraft to a PC with a Type-C USB cable.
2. Run the DJI Assistant 2. Click the corresponding device name and then the Zenmuse H20/H20T firmware update tag.
3. Select the firmware version required. Make sure to connect to the Internet when downloading the firmware. Restart the device after the firmware update is complete.



- CSM Radar firmware updates are included with aircraft firmware updates.



- The battery firmware is included in the aircraft firmware. Be sure to update the firmware of all batteries.
 - The firmware of the Zenmuse H20N/L1/L2/P1 cannot be updated using DJI Assistant 2. If the firmware of the aircraft is updated using DJI Assistant 2 while the Zenmuse H20N/L1/L2/P1 is attached, only the aircraft firmware will be updated. Use an SD card or DJI Pilot 2 to update the firmware of Zenmuse H20N/L1/L2/P1.
 - Make sure all DJI devices are connected properly to the PC during an update.
-



- During the update process, it is normal for the gimbal to go limp, the aircraft status indicators to blink, and the aircraft to reboot. Wait patiently for the update to complete.
 - Make sure to keep the aircraft away from people and animals during a firmware update, system calibration or parameter configuration.
 - Make sure you are using the latest firmware version.
 - After the firmware update is completed, the remote controller and the aircraft may become disconnected. Re-link them if necessary.
 - DO NOT use other Hardware and Software than specified by the manufacturer.
-

Firmware Version Information

Refer to the Release Notes for more firmware update information for traceability.

<https://enterprise.dji.com/matrice-350-rtk/downloads>

Appendix

This chapter provides the specifications.

Appendix

Specifications

Aircraft

Dimensions (unfolded, without propellers)	810×670×430 mm (L×W×H)
Dimensions (folded, with propellers)	430×420×430 mm (L×W×H)
Diagonal Wheelbase	895 mm
Weight (with single downward gimbal)	Without batteries: Approx. 3.77 kg With two TB65 batteries: Approx. 6.47 kg
Single Gimbal Damper's Max Payload	960 g
Max Takeoff Weight	9.2 kg
Operating Frequency	2.4000-2.4835 GHz 5.150-5.250 GHz (CE: 5.170-5.250 GHz) 5.725-5.850 GHz In some countries and regions, the 5.1 GHz and 5.8 GHz frequency bands are prohibited, or the 5.1 GHz frequency band is only allowed for indoor use. Please refer to local laws and regulations for more information.
Transmitter Power (EIRP)	2.4000-2.4835 GHz: < 33 dBm (FCC), < 20 dBm (CE/SRRC/MIC) 5.150-5.250 GHz (CE: 5.170-5.250 GHz): < 23 dBm (CE) 5.725-5.850 GHz: < 33 dBm (FCC/SRRC), < 14 dBm (CE)
Hovering Accuracy (with moderate or no wind)	Vertical: ±0.1 m (with vision positioning) ±0.5 m (with GNSS positioning) ±0.1 m (with RTK positioning) Horizontal: ±0.3 m (with vision positioning) ±1.5 m (with GNSS positioning) ±0.1 m (with RTK positioning)
RTK Positioning Accuracy (RTK FIX)	1 cm + 1 ppm (horizontal), 1.5 cm + 1 ppm (vertical)
Max Angular Velocity	Pitch: 300°/s, Yaw: 100°/s
Max Pitch Angle	30° (when in N mode and with the forward vision system enabled: 25°)
Max Ascent Speed	6 m/s
Max Descent Speed (vertical)	5 m/s
Max Descent Speed (tilt)	7 m/s

Max Horizontal Speed	23 m/s
Max Flight Altitude	5000 m (when using the 2110s propellers and with the takeoff weight ≤ 7.4 kg) 7000 m (when using the 2112 High-Altitude Low-Noise Propellers and with the takeoff weight ≤ 7.2 kg)
Max Wind Resistance	12 m/s
Max Flight Time	55 minutes (measured with Matrice 350 RTK flying at approximately 8 m/s without payloads in a windless environment until the battery level reached 0%. Data is for reference only. Actual usage time may vary depending on the flight mode, accessories, and environment. Please pay attention to reminders in the app)
Supported DJI Gimbals	Zenmuse H20, Zenmuse H20T, Zenmuse H20N, Zenmuse P1, Zenmuse L1, and Zenmuse L2
Supported Gimbal Configurations	Single downward gimbal Single upward gimbal Dual downward gimbals Single downward gimbal + single upward gimbal Dual downward gimbals + single upward gimbal
Ingress Protection Rating	IP55 (the IP rating is not permanently effective and may decrease due to product wear and tear)
GNSS	GPS+GLONASS+BeiDou+Galileo
Operating Temperature	-20° to 50°C (-4° to 122° F)
Remote Controller	
General	
Screen	7.02-inch LCD touchscreen; resolution: 1920×1200; max brightness: 1200 nits
Weight	Approx. 1.25 kg (without WB37 battery) Approx. 1.42 kg (with WB37 battery)
GNSS	GPS+Galileo+BeiDou
Built-in Battery	Type: Li-ion (6500 mAh@7.2 V) Charging Type: Use the battery station or USB-C fast charger with a max power of 65 W (max voltage of 20 V). Charging Time: 2 hours Chemical System: LiNiCoAlO2
External Battery (WB37 Intelligent Battery)	Capacity: 4920 mAh Voltage: 7.6 V Type: Li-ion Energy: 37.39 Wh Chemical System: LiCoO2
Ingress Protection Rating	IP54
Operating Time	Built-in Battery: approx. 3 hours and 18 mins Built-in Battery + External Battery: approx. 6 hours

Operating Temperature	-20° to 50° C (-4° to 122° F)
Operating Frequency	2.4000-2.4835 GHz, 5.725-5.850 GHz
Transmitter Power (EIRP)	2.4 GHz: < 33 dBm (FCC), < 20 dBm (CE/SRRC/MIC) 5.8 GHz: < 33 dBm (FCC), < 14 dBm (CE), < 23 dBm (SRRC)

O3 Enterprise

Antenna	4 video transmission antennas, 2T4R
Max Transmission Distance (unobstructed, free of interference)	20 km (FCC), 8 km (CE/SRRC/MIC)
Max Transmission Distance (with interference)	<p>Low Interference and Obstructed by Buildings: approx. 0-0.5 km</p> <p>Low Interference and Obstructed by Trees: approx. 0.5-3 km</p> <p>Strong Interference and Unobstructed: urban landscape, approx. 1.5-3 km</p> <p>Medium Interference and Unobstructed: suburban landscape, approx. 3-9 km</p> <p>Low Interference and Unobstructed: suburb/seaside, approx. 9-20 km</p> <p>Measured with FCC compliance in unobstructed environments with typical interference at a flight altitude of approximately 120 m. Data is for reference only. The actual transmission distance may vary depending on the environment's obstruction and interference conditions. Please pay attention to reminders in the app.</p>

Wi-Fi

Protocol	Wi-Fi 6
Operating Frequency	2.4000-2.4835 GHz; 5.150-5.250 GHz; 5.725-5.850 GHz

Bluetooth

Protocol	Bluetooth 5.1
Operating Frequency	2.4000-2.4835 GHz

Vision System

Obstacle Sensing Range	Forward / Backward / Left / Right: 0.7-40 m Upward / Downward: 0.6-30 m
FOV	Forward/Backward/Downward: 65° (horizontal), 50° (vertical) Left/Right/Upward: 75° (horizontal), 60° (vertical)
Operating Environment	Surfaces with discernible patterns and adequate lighting (lux > 15)

Infrared Sensing System

Obstacle Sensing Range	0.1 - 8 m
FOV	30° (±15°)
Operating Environment	Large, diffuse, and reflective obstacles (reflectivity >10%)

LED Auxiliary Light

Effective Illumination Distance	5 m
Illumination Type	60 Hz, solid glow

FPV Camera

Resolution	1080p
FOV	142°
Frame Rate	30fps

Intelligent Flight Battery

Model	TB65
Capacity	5880 mAh
Voltage	44.76 V
Battery Type	Li-ion
Energy	263.2 Wh
Net Weight (Single One)	Approx. 1.35 kg
Operating Temperature	-20° to 50° C (-4° to 122° F)
Ideal Storage Temperature	22° to 30° C (71.6° to 86° F)
Charging Temperature	-20° to 40° C (-4° to 104° F)

When the ambient temperature is below 5° C (41° F), the battery will trigger the auto-heating function. Charging at low temperatures may reduce battery life. It is recommended to charge at 15° to 35° C (59° to 95° F).

Charging Time	<p>With a 220V power supply, it takes approximately 60 minutes to fully charge two TB65 Intelligent Flight Batteries and approximately 30 minutes to charge them from 20% to 90%.</p> <p>With a 110V power supply, it takes approximately 70 minutes to fully charge two TB65 Intelligent Flight Batteries and approximately 40 minutes to charge them from 20% to 90%.</p>
---------------	---

Using the Upward Gimbal Connector

The Matrice 350 RTK Upward Gimbal Connector is used to mount a compatible payload to the top of the Matrice 350 RTK aircraft. Its design gives it an IP44 Ingress Protection (only when equipped with a waterproof payload), in accordance with the global IEC 60529 standard.

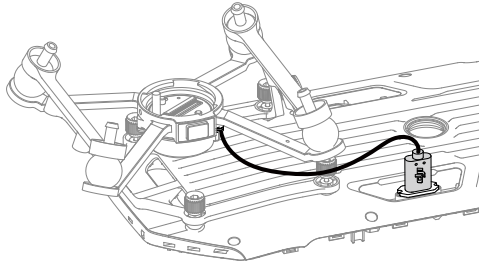

Using the Dual Gimbal Connector

The Matrice 350 RTK Dual Gimbal Connector is used to mount a compatible payload to the bottom of the Matrice 350 RTK aircraft. Its design gives it an IP44 Ingress Protection (only when equipped with a waterproof payload), in accordance with the global IEC 60529 standard.

1. Remove the single downward gimbal connector.

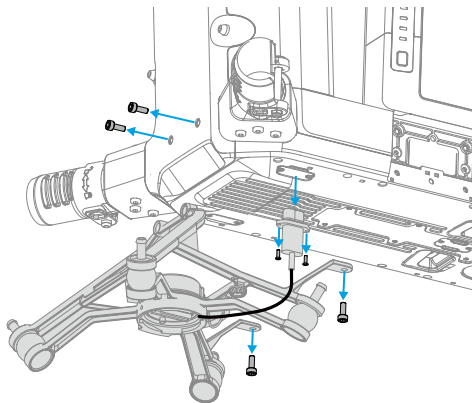

2. Attach the Dual Gimbal Connector, and connect the cables.

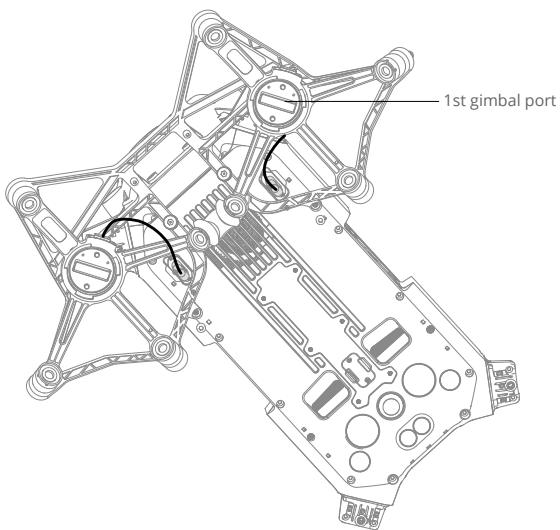
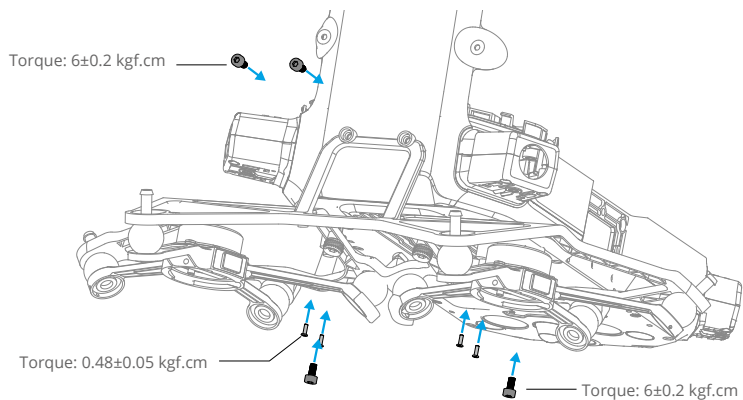

Using the CSM Radar

Installing and Connecting

CSM Radar can be used with M350 RTK. Follow the steps below to install and connect it.

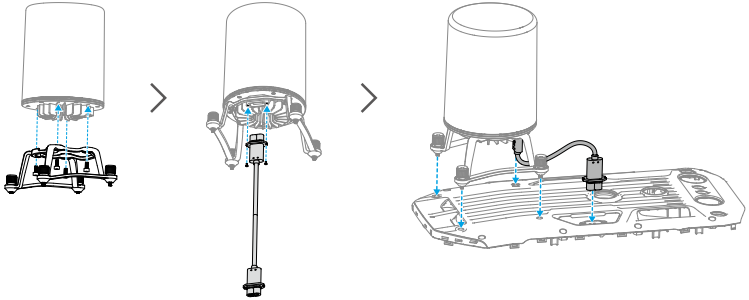

Usage

For an added safety measure, a Circular Scanning Millimeter-Wave (CSM) Radar with a detection range between 1.5 to 30 m can be mounted on top of the aircraft.

Detection Range

Detection angle: 360° in horizontal direction, 60° in vertical direction, and 45° in upper direction.
Detection distance: 1.5-30 m.

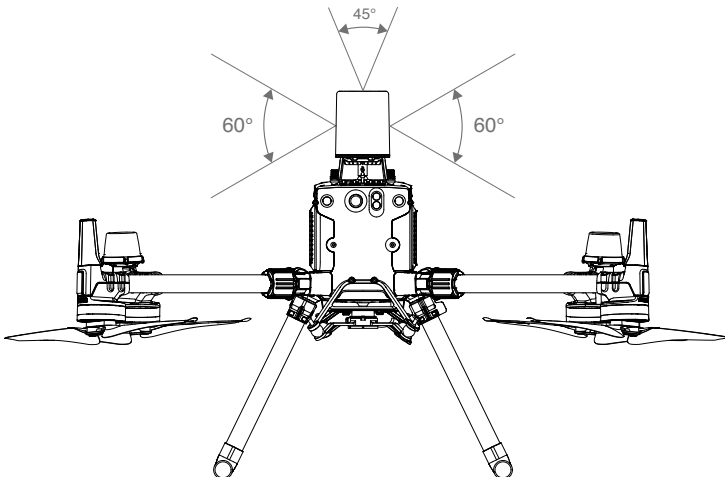

- ⚠ • Note that the aircraft cannot sense obstacles that are not within the detection range. Fly with caution.
 - The effective detection distance varies depending on the size and material of the obstacle. For example, when sensing strong reflective objects (such as buildings), the effective detection distance is around 30 m. When sensing weak reflective objects (such as dry tree branches), the distance is around 15 m. Obstacle sensing may malfunction or be invalid in areas outside of the effective detection distance.
-

Obstacle Avoidance Function Usage

The radar obstacle avoidance function should be enabled in the DJI Pilot 2 App. Set the aircraft safety distance (recommended to be greater than 2.5 m) in app. Maintain a flight speed less than 10 m/s when the radar module is in use. Flying higher than 4 m is recommended for better obstacle avoidance performance.

- ⚠ • DO NOT touch or let your hands or body come in contact with the metal parts of the radar module when powering on or immediately after flight as they may be hot.
 - In Manual operation mode, users have complete control of the aircraft. Pay attention to the flying speed and direction when operating. Be aware of the surrounding environment and avoid the blind spots of the radar module.
 - If another device is installed on the aircraft, please avoid blocking the radar FOV. If the radar FOV is blocked, the obstacle avoidance performance of the radar may decrease. Please fly with caution.
 - Obstacle Avoidance is disabled in Attitude mode.
 - Maintain full control of the aircraft at all times and DO NOT rely on the radar module and DJI Pilot 2 app. Keep the aircraft within VLOS at all times. Use your discretion to operate the aircraft manually to avoid obstacles.
 - The radar modules sensitivity can be reduced when operating several radar equipped aircraft within a short distance from each other. Fly with caution.
 - Before use, make sure that the radar module is clean and the outer protective cover is not cracked, chipped, sunken, or misshapen.
 - DO NOT attempt to disassemble any part of the radar module that has already been mounted prior to shipping.
 - The radar module is a precision instrument. DO NOT squeeze, tap, or hit the radar module.
-
- ☀ • If the radar module frequently detects obstacles incorrectly, check to make sure the mounting bracket and the aircraft landing gear are properly secured. If the radar module still does not work, contact DJI Support or a DJI authorized dealer.
 - Keep the protective cover of the radar module clean. Clean the surface with a soft damp cloth and air dry before using again.
-

Specifications

Model	DR2424R
Operating Frequency	24.05-24.25 GHz
Power Consumption	12 W
Transmitter Power (EIRP)	SRRC: <13 dBm NCC/MIC/KCC/CE/FCC: <20 dBm
IP Rating	IP45
Dimensions	75×75×105.4 mm
Weight (without mounting bracket and cables)	336 g
Operating Temperature	-20° to 50°C (-4° to 122° F)

Extended Screw Holes Description

Use the specified screw to avoid damage to the thread of the screw hole. Make sure that the accessories are firmly installed.

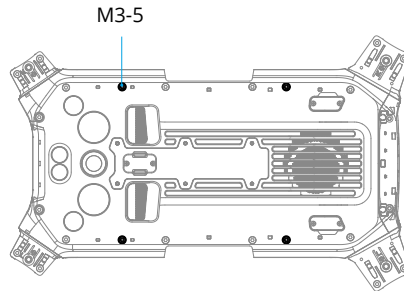

Troubleshooting Procedures

1. Why can the battery not be used before the first flight?
The battery must be activated by charging before using it for the first time.
2. How to solve the gimbal drift issue during flight?
Calibrate IMU and compass in DJI Pilot 2. If the problem persists, contact DJI Support.
3. No function
Check if the Intelligent Flight battery and the remote controller are activated by charging. If the problems persist, contact DJI Support.
4. Power-on and start-up problems
Check if the battery has power. If yes, contact DJI Support if it cannot be started normally.
5. SW update issues
Follow the instructions in the user manual to update the firmware. If the firmware update fails, restart all the devices and try again. If the problem persists, contact DJI Support.
6. Procedures to reset to factory default or last known working configuration
Use the DJI Pilot 2 app to reset to factory default.
7. Shutdown and power-off problems
Contact DJI Support.
8. How to detect careless handling or storage in unsafe conditions
Contact DJI Support.

Risk and Warnings

When the aircraft detects a risk after powering on, there will be a warning prompt on DJI Pilot 2. Pay attention to the list of situations below.

1. If the location is not suitable for takeoff.
2. If an obstacle is detected during flight.
3. If the location is not suitable for landing.
4. If the compass and IMU experience interference and need to be calibrated.
5. Follow the on-screen instructions when prompted.

Disposal

Observe the local regulations related to electronic device when dispose the aircraft and remote controller.

Battery Disposal



Dispose of the batteries in specific recycling containers only after a complete discharge. DO NOT dispose of the batteries in regular trash containers. Strictly follow the local regulations regarding the disposal and recycling of batteries.

Dispose of a battery immediately if it cannot be powered on after over-discharging.

If the battery level button on the battery is disabled and the battery cannot be fully discharged, contact a professional battery disposal/recycling agency for further assistance.

C3 Certification

Matrice 350 RTK is complied with C3 certification, there are some requirements and restrictions when using Matrice 350 RTK in European Economic Area (EEA, i.e. EU plus Norway, Iceland and Liechtenstein).

UAS Class	C3
Sound power level	97 dB(A)
Maximum Propeller Speed	4700 RPM

MTOM Statement

The MTOM of Matrice 350 RTK (Model M350 RTK), including two batteries, gimbal camera, lens, four propellers and thirty-party payloads, is not larger than 9.2 kg to comply with C3 requirement.

Users must follow the instructions below to comply with the MTOM C3 requirements. Otherwise, the aircraft cannot be used as a C3 UAV:

1. Make sure that the MTOM is not larger than 9.2 kg for any flight.
2. DO NOT use any non-qualified replacement parts, such as propeller, intelligent flight battery, etc.
3. DO NOT retrofit the aircraft.

When adding a payload, make sure the size and mounting position is proper, the maximum payload dimensions is 0.2 m × 0.2 m×0.2 m, and the payload should not block the vision systems, the infrared sensing systems, and the heat dissipation area. The gravity of the payload should be in the center of the aircraft.

Direct Remote ID

1. Transport Method: Wi-Fi Beacon.
2. Method of uploading the UAS Operator Registration Number to the aircraft: enter DJI Pilot 2 > GEO Zone Map > UAS Remote Identification, and then upload UAS Operator Registration Number.
3. According to applicable rules, operators shall provide correct registration number to be broadcast in flight. Please make sure you understand and comply with the rules before exit.

List of Items, including Qualified Accessories

- Quick-Release Propellers (Pair) (Model: DJI 2110s, 70 g)
- TB65 Intelligent Flight Battery (Model: TB65-5880mAh-44.76V, 1.35 kg)
- Zenmuse H20 (Model: ZH20, 678±5 g)
- Zenmuse H20T (Model: ZH20T, 828±5 g)
- Zenmuse H20N (Model: ZH20N, 878±5 g)
- Zenmuse P1 (Model: ZP1, 800 g)
- Zenmuse L1 (Model: ZL1, 930±10 g)
- Upward Gimbal Connector (150×123×60 mm, 121.3 g)
- Downward Gimbal Connector (155×152×90 mm, 111.4 g)
- Dual Gimbal Connector (337×162×78 mm, 240 g)

List of Spare and Replacement Parts

- Quick-Release Propellers (Pair) (Model: DJI 2110s)
- TB65 Intelligent Flight Battery (Model: TB65-5880mAh-44.76V)

Remote Controller Warnings

The remote controller indicator will glow red after disconnecting from the aircraft for more than 2 seconds.

DJI Pilot 2 will prompt a warning after disconnecting from the aircraft.

There will be an alert if the remote controller is not used for five minutes while it is powered on but the touchscreen is off and it is not connected to the aircraft. It will automatically power off after a further 30 seconds. Move the control sticks or perform any other remote controller action to cancel the alert.



- Avoid interference between the remote controller and other wireless equipment. Make sure to turn off the Wi-Fi on nearby mobile devices. Land the aircraft as soon as possible if there is interference.
 - Users are responsible for correctly adjusting the display brightness when using the remote controller in direct sunlight during flight operation.
 - Release the control sticks or press the flight pause button if an unexpected operation occurs.
-

GEO Awareness

Drone Geo-Zones and DJI Geo Zones

DJI is committed to maintaining a safe flying environment. This includes abiding by local regulations and Unmanned Geographical Zones (UGZs) defined by EU national authorities. DJI has its own Geospatial Environment Online system (GEO) with broader geographical zones, including regulated areas where flight may raise concerns. DJI's GEO system has been running successfully for many years, effectively protecting flight safety and public safety in the absence of official UGZ databases.

In the future, DJI Geo zones will coexist with EU UGZs, as UGZs are still not available in many countries. Users are responsible for checking local regulations and for any flight restrictions where they intend to operate.

The GEO zones mentioned in the manual and DJI official website refers to the DJI Geo zones and Geo fencing function, not the UGZs for Geo awareness function required by regulations.

AGL (Above Ground Level) Statement

The vertical limits of Geo-Awareness may use the AMSL altitude or the AGL height. The choice between these two references is specified individually for each UGZ. Neither AMSL altitude nor the AGL height is supported by this product. H (Height) appears in the app camera view, which is the height from the aircraft takeoff point to the aircraft. The height above the takeoff point may be used as an approximation but may differ more or less from the given altitude/height for a specific UGZ. The remote pilot remains responsible for not breaching the vertical limits of the UGZ.

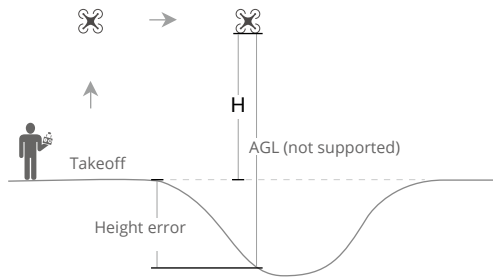

Restricted Zones

In these Zones, which appear red the DJI App, users will be prompted with a warning and flight is prevented (UA cannot get in and cannot take off in this type zone), If you believe you have the authorization to operate in a Restricted Zone, please contact flysafe@dji.com or Online Unlocking.

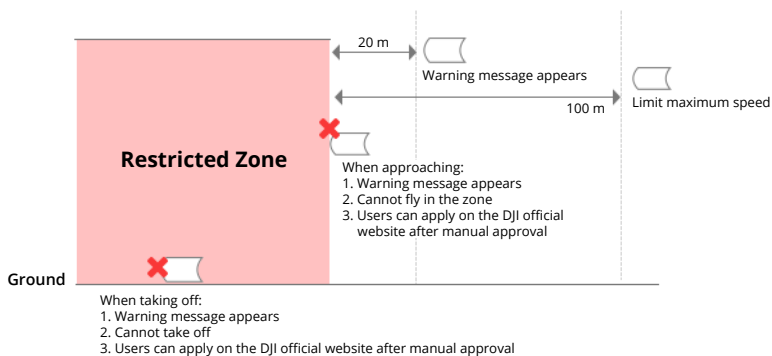

Authorization Zones

In these Zones, which appear blue in the DJI App, users will be prompted with a warning and flight is limited by default. UA cannot get in and cannot take off in these type zone unless authorized. Authorization Zones may be unlocked by authorized users using a DJI verified account.

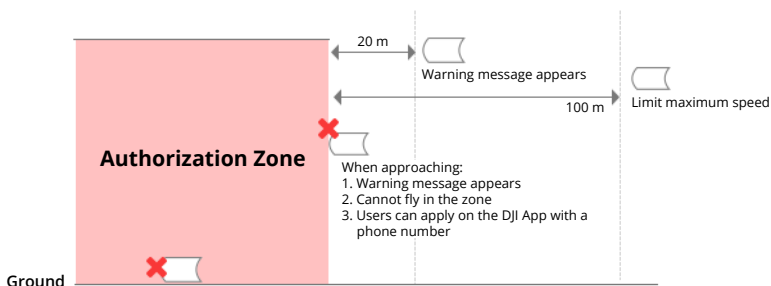

Altitude Zones

Altitude zones means zones have limited altitude which will appear in gray on the map. When approaching, users receive warnings in DJI App.

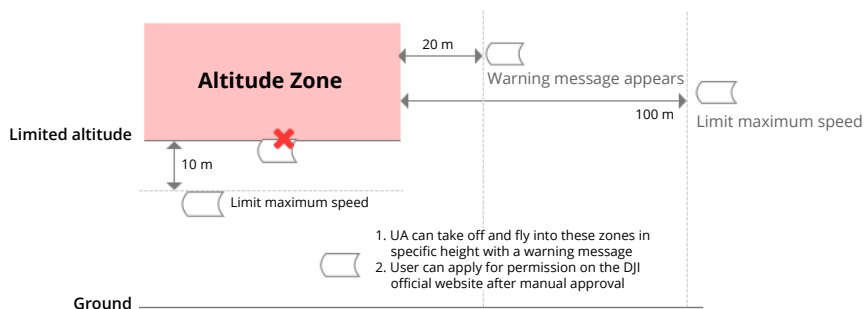

Enhanced Warning Zones: warning message will be shown to user when the drone reaches the edge of the zones.



Warning Zones: warning message will be shown to user when the drone reaches the edge of the zones.

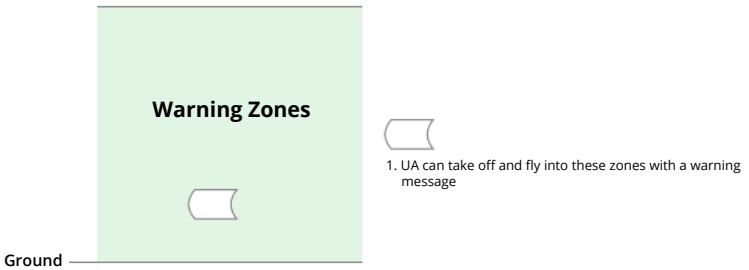

Regulatory Restricted Zones:

Due to local regulations and policies, flights are prohibited within the scope of some special areas. (Example: Prison)

Approved Zones for Light UAVs (China):

For Approved Zones, pilots of light UAVs flying at an altitude of 120 m or less are not required to obtain permission to fly. Pilots who are planning to fly medium-sized UAVs in Approved Zones at an altitude higher than 120 m, or in GEO Zones other than Approved Zones, must obtain permission via UTMIS before taking off.

UGZ Zone for Geo-awareness function

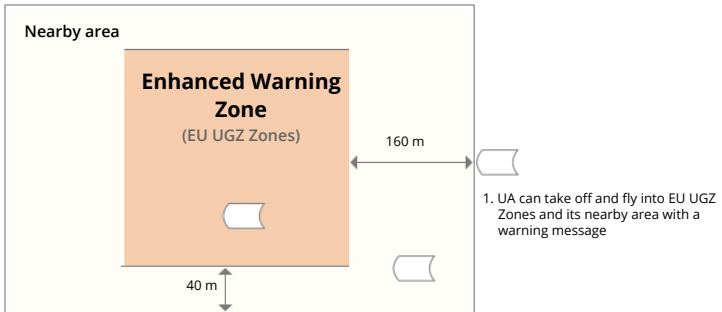

EASA Notice

Make sure to read the Drone Information Notices document included in the package before use.

Go to the address below for more EASA notice information for traceability.

<https://www.easa.europa.eu/en/document-library/general-publications/drones-information-notices>

FAR Remote ID Compliance Information

The aircraft complies with the requirements of 14 CFR Part 89:

- The aircraft automatically initiates a pre-flight self-test (PFST) of the Remote ID system before takeoff and cannot take off if it does not pass the PFST^[1]. The results of the PFST of the Remote ID system can be viewed in a DJI flight control app such as DJI Pilot.
The aircraft monitors the Remote ID system functionality from pre-flight to shut down. If the Remote ID system malfunctions or has a failure, an alarm will be displayed in a DJI flight control app such as DJI Pilot.
- The user shall keep the DJI flight app running in the foreground and always allow it to obtain the location information of the remote controller.
- Developers who develop third-party applications based on the DJI Mobile SDK shall obtain and display the PFST results and the failure status of the Remote ID system during operation by calling specific APIs^[2].

[1] The pass criterion for PFST is that the hardware and software of the Remote ID required-data source and transmitter radio in the Remote ID system are functioning properly.

[2] For detailed APIs information, please visit <https://developer.dji.com/mobile-sdk>.

After-Sales Information

Visit <https://www.dji.com/support> to learn more about after-sales service policies, repair services, and support.



The terms HDMI, HDMI High-Definition Multimedia Interface, HDMI trade dress and the HDMI Logos are trademarks or registered trademarks of HDMI Licensing Administrator, Inc.

WE ARE HERE FOR YOU



Contact
DJI SUPPORT

This content is subject to change.

<https://enterprise.dji.com/matrice-350-rtk/downloads>

If you have any questions about this document, please contact DJI by sending a message to DocSupport@dji.com.

DJI and MATRICE are trademarks of DJI.
Copyright © 2023 DJI All Rights Reserved.