



# LiAir 220N

## UAV LIDAR System

### User Guide

GreenValley International Inc. (GVI) reserves all right for final explanation, and at its sole discretion, to change, modify, and remove portions of this document.

No Part of this document may be reproduced or transmitted in any form or by any means, electronic, mechanical, photocopying, recording, or otherwise, without prior written permission of GreenValley International Inc.

GreenValley International Inc.  
2120 University Ave. Ste. 210  
Berkeley, CA. 94706  
USA

+1 510.345.2899

[info@greenvalleyintl.com](mailto:info@greenvalleyintl.com)

[www.greenvalleyintl.com](http://www.greenvalleyintl.com)

## About This Guide

This document is a general introduction and operation guide for GVI's LiAir 220N lightweight UAV LIDAR mapping/survey systems.

**As we continue to update and improve the product, you may find some differences between the contents of this document and your LiAir 220N system. We will diligently update this guide as the product changes.**

Please check with GVI for the latest release of this guide and contact GVI support at [suppprt@greenvalleyintl.com](mailto:suppprt@greenvalleyintl.com) if you have any questions.

# Content

<b>1. Read This First.....</b>	<b>5</b>
<b>2. LiAir 220N System .....</b>	<b>6</b>
2.1 About .....	6
2.2 System Basics.....	6
2.3 System Principles.....	6
2.4 Technical Specification .....	7
2.5 LiAir 220N System Components .....	8
2.5.1 Laser Scanner .....	8
2.5.2 Position and Orientation System (POS) .....	9
2.5.3 Control and Storage Unit .....	10
2.5.4 Integrated Camera (Optional).....	13
<b>3. Equipment Setup and Operation Procedure.....</b>	<b>13</b>
3.1 Assemble and install LiAir 220N Payload Mounting Kit.....	13
3.2 Set up GNSS Base Station .....	13
3.3 LiAir 220N Setup and Operation (DJI M300) .....	16
<b>4. Data Download.....</b>	<b>20</b>
4.1 Download LiAir 220N Data .....	20
4.2 Download Base Station Data .....	21
4.3 Download Camera Data .....	21
<b>5. Data Processing.....</b>	<b>22</b>
5.1 Project Folder Structure .....	22
5.2 Data Post-processing .....	24
5.2.1 Open Project .....	24
5.2.2 Select and Configure Parameters .....	25
5.2.3 Georeferencing Point Cloud Data .....	31
5.2.4 Data Quality Assessment.....	33
<b>6. Special Notes .....</b>	<b>42</b>

# 1. Read This First

## Important Notices

**STOP! PLEASE READ THIS SECTION CAREFULLY BEFORE USING THE PRODUCT!**

- ✦ LiAir 220N systems use Class 1 (IEC60825-1:2014) eye-safe laser sensors. If you have any concerns, please contact GVI for details.
- ✦ System operator must be at least 18 years old.
- ✦ Tampering with the product is strictly prohibited and will void the Product Warranty. Any repair, modification, or upgrade must be performed by GVI technician or authorized service provider.
- ✦ Do NOT use any power supply outside the specified voltage range (**12~24 V, 1.1A@24VDC**). Incorrect voltage supply may cause permanent damages to the integrated instruments and other hazards. Damage caused by the use of an unauthorized power supply are not covered by the Product Warranty.
- ✦ STOP using the product and contact GVI support immediately, if there is any visible damage or if persistent system warnings or alarms are observed. Failure to do so may result in permanent damage to the LiAir 220N system.
- ✦ This product is NOT water-proof. Do NOT operate in rain or snow. Water damage is NOT covered by the Product Warranty.
- ✦ This product is a high-precision mapping and surveying instrument that must be handled with care. Damage caused by improper handling of the product are not covered by the Product Warranty.
- ✦ Properly disconnect all batteries, antennas, and cables after use.
- ✦ This product should be stored and transported in the protective case provided with the LiAir 220N at the time of purchase or in a protective case authorized for use by GVI.
- ✦ Clean the product thoroughly after each use. Do NOT use water.
- ✦ When not in use, store LiAir 220N system and accessories in a cool and dry environment.

**There may be additional notices and warning in placed throughout part this document. Read each notice and warning carefully and please follow the instructions.**

## 2. LiAir 220N System

### 2.1 About

LiAir 220N UAV-LIDAR system is a light-weighted (2.0 kg incl. camera) and 3D surveying and mapping instrument designed to be mounted to multi-rotor aerial platforms (DJI M300 & DJI M600). LiAir 220N provides accuracy point cloud data for users in various industries including topographic surveying, forestry, vegetation management, power line inspection, and many more. For additional information on LiAir 220N, please contact GVI at [info@greenvalleyintl.com](mailto:info@greenvalleyintl.com).

### 2.2 System Basics

The LiAir 220N system integration is comprised of multiple technologies, including:

- Laser Scanner (LIDAR sensor)
- GNSS (Global Navigation Satellite System)
- IMU (Inertial Measurement Unit)
- System Control and Storage Unit
- Power Supply and Management Unit

**The GNSS unit and IMU unit together form what is often referred to as the LiAir 220N's POS Module.**

### 2.3 System Principles

- In operation, the System Controller receives and executes operational commands that control the collection of data by each of the LiAir 220N's integrated sensors and measurement devices.
- The POS Module (GNSS and IMU) determines LiAir 220N's position and attitude at any given point in time. This time-series position and attitude data is commonly referred to as the LiAir 220N's trajectory or POS data.

- The precise 3D coordinates of each data (LiDAR) point measured by the LiAir 220N's Laser Scanner are registered together to a common coordinate system and georeferenced using the POS data.
- LiAir 220N data are saved to the System Control and Storage Unit and can be downloaded from the device after data collection has been stopped.

## 2.4 Technical Specification

**Table 1. LiAir 220N Ultralight Specifications**

LiAir 220N SPECIFICATIONS		
<b>Key Parameters</b>	Weight	2.0kg (Incl. camera)
	Scan Range	200 m @ 10% reflectivity
	System Accuracy	± 5 cm
	Voltage	12~24 V, 1.1A @ 24 VDC
	Effective Scan Rate	720,000 points/s (Last or strongest return)
	Working Temperature	0°C ~40°C
	Storage Temperature	-10°C ~60°C
	Dimensions	234 * 118* 181 mm
<b>LIDAR Unit</b>	Wavelength	905nm
	Field of View	360°(horizontal) ×40° (vertical)
	Eye-safe Laser Sensors	Class 1 (IEC60825-1:2014) (Safe for Eye)
	Range Accuracy	2cm
	# of Lines	40
	Horizontal Resolution Vertical Resolution	0.2° - 0.4° (horizontal) 0.33° -6°(vertical)
	Scan Rate	720,000 points/s ( Last or strongest return) 1440,000 points/s (dual return)

<b>Integrated Navigation System</b>	GNSS	GPS, GLONASS, GALILEO & BeiDou
	POS System Performance (after post-processing)	Attitude: 0.008° Azimuth: 0.038°
<b>Drone Suppliers</b>	DJI	DJI M300 RTK & DJI Matrice 600 Pro
<b>Georeferencing Software</b>	Acquisition/PP POS Software	LiGeoreference, (a self-developed LIDAR point cloud georeferencing software)

## 2.5 LiAir 220N System Components

### 2.5.1 Laser Scanner

The Hesai Pandar40P is the LIDAR sensor integrated into the LiAir 220N Ultralight system. The LiDAR sensor transmits an ultrashort pulse of NIR energy that strikes objects within the Laser Scanner’s field of view and reflects back to the Laser Scanners receiver as a light echo. By measuring the amount of time that has elapsed between signal transmission and signal reception (detection), the distance from the laser scanner to the reflecting object can be determined.

As shown below, the Hesai Pandar40P has a FOV of 360° horizontally and 40° vertically. Note that the effective detecting distance of the Hesai Pandar40P varies based on where the object is within the FOV. The closer to the edge of the FOV, the shorter the effective detecting distance is. The closer to the center of the FOV, the further the effective detecting distance.



Figure 1. LiAir 220N Product



**Notice: Avoid direct exposure of the laser scanner to any laser pulse from other laser transmitters. The laser scanner cannot be directed by any strong laser (including the laser from laser transmitter of other laser scanner). The strong laser can do permanently damage to the receiver of the laser scanner.**

## 2.5.2 Position and Orientation System (POS)

The airborne Position Orientation System (POS) is an inertial measurement unit (IMU) and Global Navigation Satellite System (GNSS). POS systems are used to accurately determine system velocity, position, and attitude values at specific moments in time.

### a) Global Navigation Satellite System (GNSS)

Global navigation satellite system, or (GNSS) on LiAir 220N supports, mainly includes GPS, GPS (the U.S.), Galileo satellite navigation system, (Europe), BeiDou Navigation Satellite System (China), and GLONASS (Russia). The GNSS of LiAir 220N includes the aviation GNSS antenna and the base station antenna.

### b) Inertial Measurement Unit (IMU)

Inertia measurement unit, or IMU, consists of a high-accuracy three-axis gyroscope and a high-accuracy three-axis accelerometer. It is the benchmark center of the LiDAR system. Its role is to get the position and orientation information without external reference data.

The LiAir 220N integrates a 3-axis MEMS (Micro-Electro-Mechanical System) gyroscope, 3-axis MEMS accelerometer and dual GNSS/BD receivers into one system, the POS system. Together the POS system components gather multi-reference parameters that provide accurate, effective and reliable (BLANK) by optimization algorithm of integrated navigation system.

Table 2. LiAir 220N Ultralight POS System Performance (after post-processing)

POS System Performance	
System Accuracy	Attitude: 0.008°
	Azimuth: 0.038°

### 2.5.3 Control and Storage Unit

#### a) Function:

- Receiving the commands from the computer and executes the commands.
- Controlling and coordinating each sensor to work properly.
- Storing the data. The SD card inside is used to store the data of IMU, camera, and device log.

b) LiAir 220N Ultralight power and data ports, ON/OFF button, GNSS antenna ports, as well as indicator LEDs are located on the front and sides of the LiAir 220N's main body:

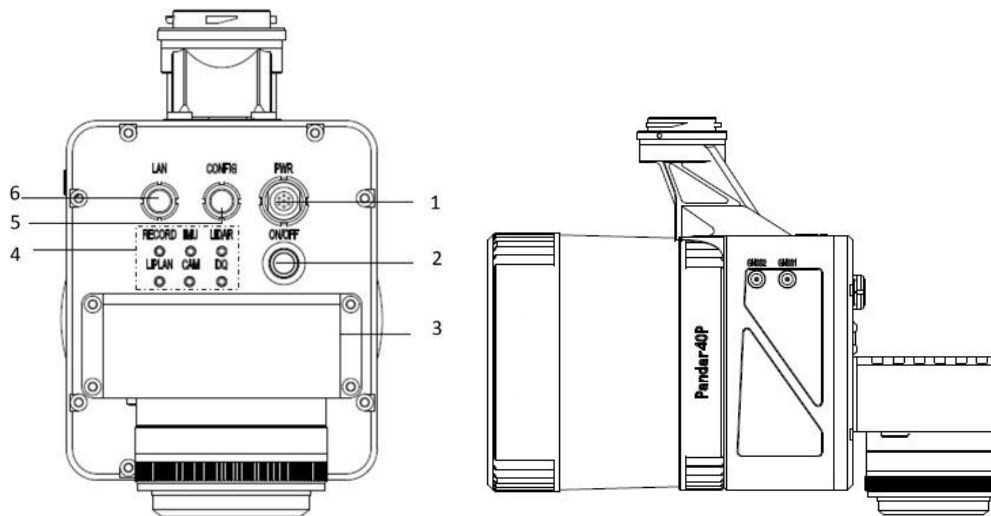

Figure 2. Front and side views of the LiAir 220N Ultralight

**1 – Power Port (marked as PWR):** This port accepts the LiAir 220N Ultralight power cable.

**2 – ON/OFF Button:** This button powers the LiAir 220N Ultralight on and off. It is also used start and stop data collection.

**3 – Camera Port (Optional)**

**4 – System Status Indicator LED Panel:** This panel of LEDs displays the integrated systems status as well as the system statuses of the separate LiAir 220N Ultralight components.

**5 – CONFIG - Debugging port that is reserved for use by the system manufacturer.**

**6 – Network Port (marked as LAN):** This port is used to connect the LiAir 220N Ultralight to a ground control computer where users can adjust system and data collection settings through a browser-based user interface. The network connection can also be also used to transfer data and updates between the LiAir system and a computer.

**7 – GNSS<sub>1</sub> Antenna Port:** This port is used to connect with the GNSS antenna with feeder cable as the first choice.

**8 – GNSS<sub>2</sub> Antenna Port:** This port is used to connect with the GNSS antenna with feeder cable as the second choice

**Table 3. On and Off Button**

Detailed Explanation of ON/OFF Button Operation and LED Light Status Descriptions			
ON/OFF Button Function	Button-hold Time	ON/OFF Button LED Light Status	Description of Status
Power-up and Power-down the device	2-3 s (long press)	Flashing <b>Red</b>	System is in initializing
		Flicking slowly <b>Red</b>	System initialization (completed)
		Solid <b>Red</b>	System starts successfully
	4-5 s (long press)	Off	Power down system
Begin & End data collection	0-2 s (short press)	Solid <b>Blue</b> DA Indicator LED	Project created and IMU+GNSS data are being collected

(while device is powered ON)			LIDAR data collection will begin and end automatically based on the user defined velocity and flight-height or - speed parameter values.
	0-2 s (repress)	DA Indicator LED Off	Not recording IMU, GNSS, or Laser Scan data

*Detailed Figures and Tables describing LiAir 220N Ultralight Indicator LED panel:*

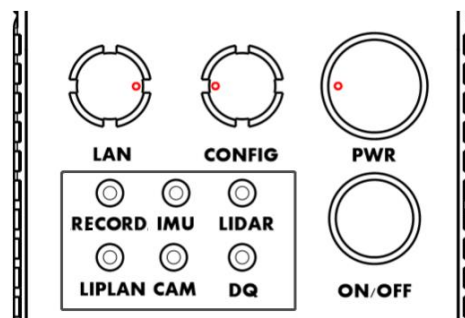

Figure 3. Partial View of LiAir 220N Ultralight Control Panel

Table 4. Detailed explanations of Indicator LED light statuses displayed on the LiAir 220N Ultralight Control Panel

Explanation of Indicator LEDs		
LED	Light Status	Description Status
ON/OFF	Flashing <b>Red</b> (flashes two times per second)	System is in initializing
	Flicking slowly <b>Red</b> (flashes one time per second)	System initialization (completed)
	Solid <b>Red</b>	System started successfully
RECORD	Solid <b>Blue</b>	Project created and IMU+GNSS data are being collected
	Flicking slowly <b>Blue</b> (flashes one time per second)	Storage is smaller than 6 GB
IMU	Solid <b>Blue</b>	IMU's initial alignment (completed)
	Solid <b>Red</b>	IMU is not aligned

<b>LIDAR</b>	Solid <b>Red</b>	LIDAR is unsynchronized
	Solid <b>Blue</b>	LIDAR is synchronized
<b>LiPlan</b>	Solid <b>Blue</b>	LiPlan initialization (completed)
<b>CAM</b>	Solid <b>Blue</b>	Camera started successfully
<b>DQ</b>	Solid <b>Red</b>	Poor data quality
	Flicking slowly <b>Blue</b> (1 Hz: flash once per second)	In calculating
	Solid <b>Blue</b>	Good data quality

### 2.5.4 Integrated Camera (Optional)

The camera of Sony A5100 is available for the LiAir 220N Ultralight system.

Camera Specification

Brand Model Name	Key Specs.	Parameters
Sony A5100	Weight	0.2 kg
	FOV	72° × 52°
	Lens	16 mm fixed focal length lens
	Effective pixels	24.3 megapixels
	Image Sensor Type	COMS

## 3. Equipment Setup and Operation Procedure

This section of the LiAir 220N Ultralight User guide describes the recommended equipment setup and operation procedures.

### 3.1 Assemble and install LiAir 220N Payload Mounting Kit

Assembly and installation of the LiAir 220N Ultralight mounting kit can be found in the Quick Guide of Assemble and Mount LiAir 220N Payload section.

### 3.2 Set up GNSS Base Station

- (1) Select an open area for positioning

Place the GNSS antenna at an open area in order to ensure the antenna can get access to the GNSS satellites as many as possible. Apart from this, the placement spot of the GNSS antenna should be stable and far away from the electromagnetic interference.

*Note:*

- *Open areas refer to those places which are not covered by high objects. The maximum elevation mask angle of surrounding objects should be less than 15°.*
- *The source of strong electromagnetic interference might be cellular base station, high voltage transmission lines, or objects with high reflectance (e.g. mirror, large water body) which may cause the multipath propagation.*

(2) Set up base station

Connect the GNSS antenna to the GNSS receiver by the feeder cable and connect the battery to the GNSS receiver by the power cable as it shown below:

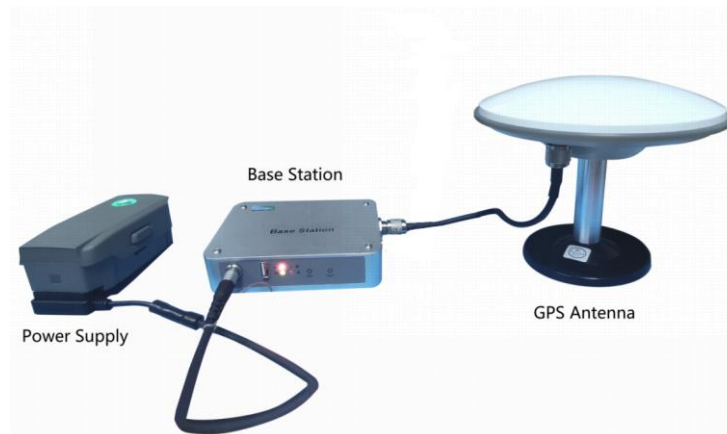

**Figure 4. Assembly of the Base Station**

*Note:*

*For higher accuracy, users can fix the base station on a tripod and place it on the known ground control point (GCP) with high absolute accuracy. When trying to connect the battery with the GNSS receiver, the red dot on the connector of the cable should be aligned with the notch on the receiver.*

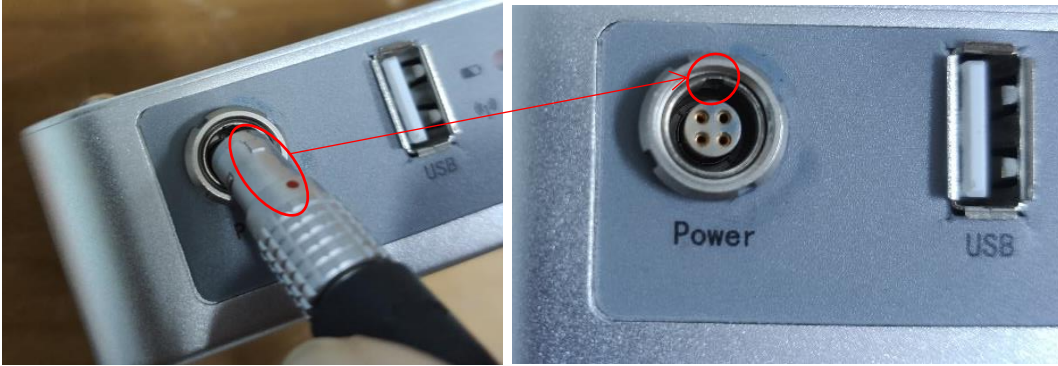

Figure 5. Power and USB Interface

(3) Calculate the antenna height

Measure the oblique distance from antenna bottom edge to the ground for more than three-times, take the mean value as H1.

$$\text{Antenna height (m)} = (0.05 - 0.046) + \sqrt{(H1)^2 - \left(\frac{0.1515}{2}\right)^2}$$



Figure 6. Calculate Antenna Height

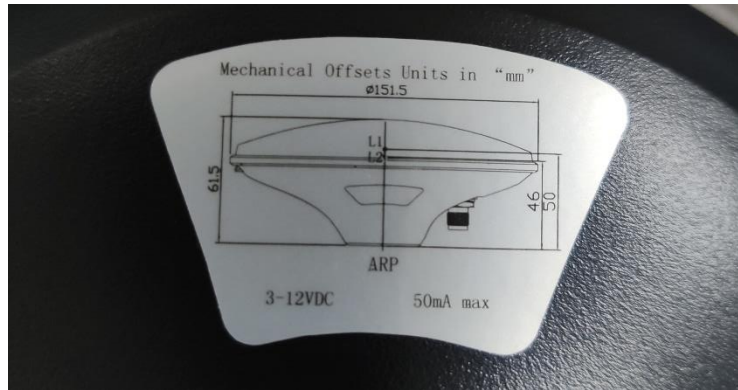

Figure 7. Size of Antenna

**Set up the GNSS Base Station as soon as site inspection is completed, and Home Location has been identified. Once Base Station data recording has started, it is necessary to not stop data collection or move the GNSS antenna for the duration of the LiAir 220N mission.**

### 3.3 LiAir 220N Setup and Operation (DJI M300)

1. Attach LiAir 220N main payload to the DJI M300/RTK system.
2. Power on the M300/RTK
3. Press ON/OFF button:
  - Hold the ON/OFF button for 2-3 seconds
  - If the light status is flashing red, the system is initializing;
  - If the light status flickers slowly red, the system components are synchronizing;
  - If the light status is solid red, system initialization and synchronization have completed successfully.
4. Connect a Ground Control computer to LiAir 220N system via Network Cable
  - When connecting a Ground Control Computer to the LiAir 220N system for the first time follow this procedure to set up the Ethernet Connection:



- a. Attach the LEMO connector of the Network Cable to the LAN port located on the front panel of the LiAir 220N main body and the opposite end of the Network Cable to the Ground Control Computer's Ethernet port.
- b. Open Windows Control Panel on Ground Station Computer Running Windows
- c. Choose Network and Internet
- d. View Network Connections
- e. Right Click on Ethernet connection for LiAir Radio Station and Choose Properties
- f. Click on "Internet Protocol Version 4 (TCP/IPv4)" and then the "Properties" button
- g. Set the IP address and Subnet mask to the following values:
  - IP address: 192.168.1.66
  - Subnet mask: 255.255.255.0

*Note: IP address should be changed if it is used for the first time.*

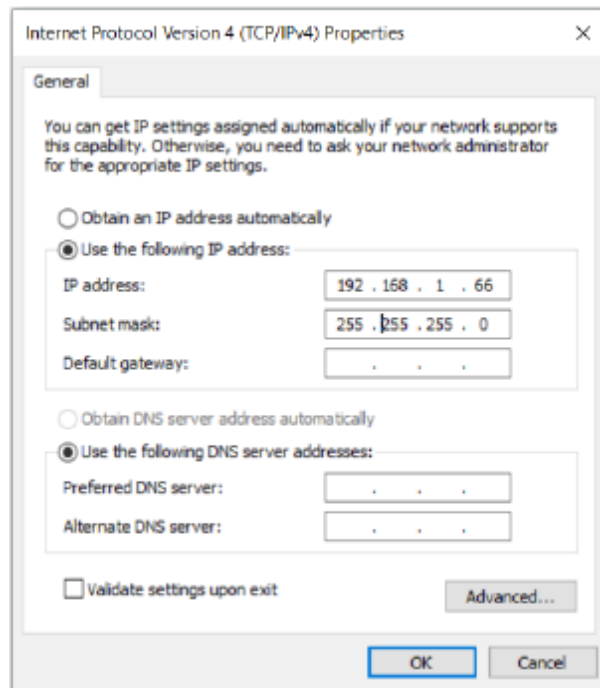

**Figure 8. Reference of Interface Settings**

- 5. Launch Google Chrome browser and navigate to <http://192.168.1.88>. This will load the LiAir 220N User Interface.

*Note: The LiAir 220N User Interface can currently be accessed through Google Chrome and Microsoft Internet Explorer*

6. Set up collection parameters

Before start scanning:

- a) Skip this step if there's no needs for resetting, and the previous parameters setting up have been already memorized as a reference.
- b) However, if there is a need for resetting, settings of LIDAR and camera could be considered as a priority. And the browser-based UI for setting up parameters looks like this:

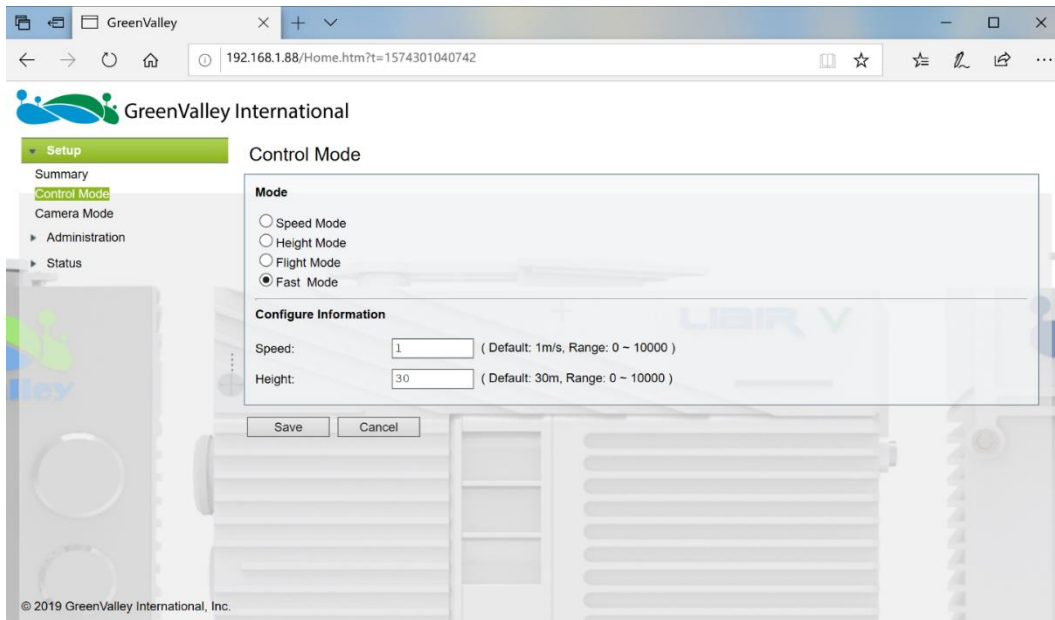

Figure 9. LiAir 220N Ultralight User Interface

- **Fast Mode:** Click collection button, create new project, and synchronize the collection of both IMU data and LIDAR data simultaneously.

*Note: Fast Mode was set as Factory Default*

- **Set of Control Mode type (Speed or Height) and value that will control the collection of LiAir 220N Laser Scanner data:**

- **Speed Mode**

- If the actual flight speed in meters per second is  $\geq$  the user defined value, the laser scanner will start
- If the actual flight speed in meters per second is  $<$  the user defined value for more than 10 seconds, the laser scanner will stop

- **Height Mode**

- If the actual flight height (in meters) is  $\geq$  the user defined value minus 5 meters, the laser scanner will start
- If the actual flight height (in meters) is  $<$  the user defined value minus 20 meters for more than 10 seconds, then stop scanning.

*Note: The setting flight height refers to the vertical distance of a UAV measured from land surface at the take-off (DJI's Home) location and not the mean sea level (Figure 7).*

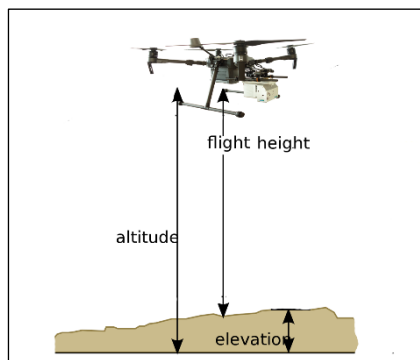

**Figure 10. The Interpretation of Flight Height Performed in LiAir 220N System**

7. Collect LiAir 220N Data

- a. Complete initialization of both IMU and LIDAR (LED indicator lights should both be solid blue)
- b. Press ON/OFF button for 0-2 seconds. The DA LED light on the front panel of the LiAir 220N Main Body will turn on to indicate that a new Project has been created and IMU data collection has begun. Note that Laser Scanner data collection will start only after use specified Control Mode (Flight Speed or Flight Height) requirements are met.
- c. Do not move or disturb LiAir 220N for 5 minutes
- d. Take off and perform two figure "8" flight maneuvers
- e. Fly pre-determined route for data collection using GVI LiPlan application or another mission/flight control application (e.g. DJI Ground Station Pro)

- f. Perform two figure "8" flight maneuvers
- g. Land the UAV and LiAir 220N
- h. Do not move or disturb LiAir 220N for 5 minutes.
- i. Press ON/OFF button for 0-2 seconds until DA indicator LED light turns off.  
At this point IMU data collection has stopped the system has closed the Project.
- j. Hold the ON/OFF button for 4-5 seconds to power off LiAir 220N system
- k. Power off UAV

## 4. Data Download

### 4.1 Download LiAir 220N Data

This section provides users with instructions on how to transfer Project data from the LiAir 220N system to another device. Each LiAir 220Nject will contain an IMU+GNSS file, a cam file (*if integrated camera data is available*), a log file, as well as the laser scan data. The recommended method for data transfer requires users to establish a connection between LiAir 220N's internal storage device and an external computer via the LEMO to Ethernet Network Cable provided by GVI with the system. Users can follow the steps below to set up this connection:

1. Connect the external computer to LiAir 220N using the provided LEMO to Ethernet Network Cable.
2. Open Windows Control Panel on Ground Station Computer Running Windows
3. Choose Network and Internet
4. View Network Connections
5. Right Click on Ethernet connection for LiAir Radio Station and Choose Properties
6. Click on "Internet Protocol Version 4 (TCP/IPv4)" and then the "Properties" button
7. Set the IP address and Subnet mask to the following values:
  - IP address: 192.168.1.66
  - Subnet mask: 255.255.255.0

8. Launch Windows File Explorer, and enter [\\192.168.1.88](http://192.168.1.88) to see Projects saved to the LiAir 220N's internal storage.
9. Copy the Project folder(s) from the LiAir 220N's internal storage to a target directory located on the connected computers internal or external data storage device.

Prior to data collection **it is a good practice to make sure the LiAir 220N's SD card has sufficient memory space available.**

## 4.2 Download Base Station Data

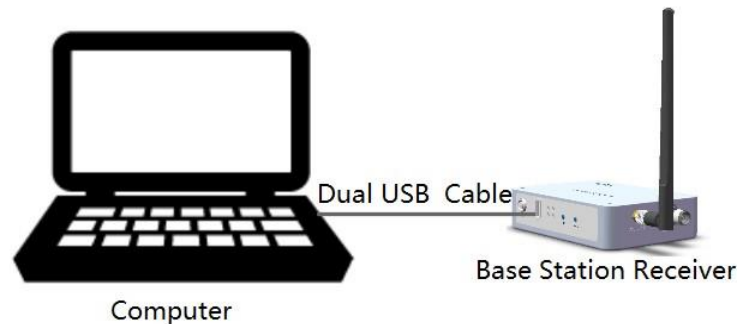

Figure 11. Connecting Base Station to a Computer for Data Download

1. Connect the Base Station to a computer via the provided USB cable.
2. The computer should recognize Base Station as an external disk.
3. Copy the Base Station data file into a newly created folder named "base" in the project folder.

**The Base Station's data files (.log) are named based on UTC time, e.g. 20170810063808.log**

## 4.3 Download Camera Data

- (1) Take out the SD card of camera.
- (2) The computer will read the camera's SD card, and please paste the images copied from camera's SD card into the "Cam" -> "Images" folder.

*Note: please do not cut any system files stored in camera's SD card. And users do not need to copy the self-calibrated images.*

## 5. Data Processing

LiGeoreference is a LiDAR point cloud georeferencing software developed by GreenValley which allows users to merge range measurements collected by mobile, UAV or airborne laser scanning systems with position and orientation information recorded by integrated IMU and GNSS sensors. Point clouds can also be attributed with RGB imagery using LiGeoreference's data fusion capabilities to produce a true-color 3D model of an object or area surveyed. LiGeoreference is now available as a stand-alone application with a helpful graphical user interface as well as a command-line interface for scripting and easy integration with third party software. In this article, the main purpose to produce this chapter is to show the data post-processing procedure resolved by LiGeoreference.

*Note: For more information, introduction of assembling LIDAR system together with Drones is detailed in [LiGeoreference User Handbook](#) section.*

### 5.1 Project Folder Structure

LiAir 220N will automatically create a project for the mission in SD card of laser scanner and associated subfolders to store incoming data on LiAir 220N's internal storage device. The organization structure of the project file is shown in the figure below.

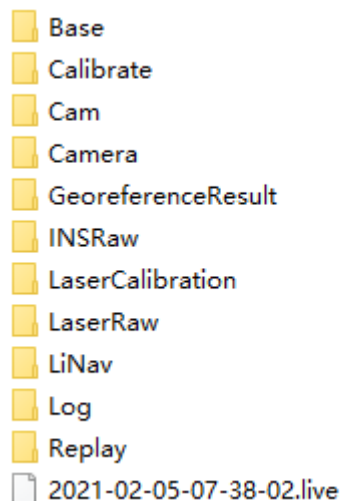

Figure 12. Project Folder Structure

Project folder is named with UTC Time, including:

- **Base folder** is used to store the ground GPS base station data.
- **Calibrate folder** is used to store calibrated files (\*.cal). Please notice that: do not remove or delete this folder, otherwise, the performance of georeferencing will fail.
- **Cam folder** is used to store the information of exposure time, location, and attitude angles of each image (.cam). And the image needs to be moved to "Cam" -> "Images" folder copied from Camera's SD card.
- **GeoreferenceResult folder** is used to store the post-processed point cloud data calculated by the Georeference software.
- **INSRaw folder** is used to store the raw IMU data (\*.imu)
- **LaserCalibration folder** is used to store the calibrated file of LiDAR (\*.csv) but only available to partial series like LiAir 200 and LiAir 220.
- **LaserRaw folder** is used to store the raw data of laser scanner's point cloud (\*.vpts). After being post-processing, it is convenient for users to convert the data's format as needed.  
*Note: \*.vpts is the default format developed by GVI.*
- **LiNav folder** is used to store the intermediate file when processing the data of integrated navigation system. What's more, the final-georeferencing results of POS data is suitable to be stored as well.
- **Log folder** is used to store the log information of the project showing detailed operation process.
- **Replay folder** is used to store the replay file of recorded trajectory and point cloud data, but only available to the specified device which supports real time display.
- **Reply folder**: is used to store the replay file of recorded trajectory and point cloud data, but only available to the specified device which supports real time display.

- \*.Live (project file) is used to record the information of project organization, configuration values, etc.

## 5.2 Data Post-processing

### 5.2.1 Open Project

- Click “**File**” icon on the toolbar to open *LiGeoreference project file* (.live) through “**Browse**” icon, and users can also open the project file via “**Recent Projects**” icon which refers to history project opened before. And both of these two user-friendly selections are available for users to start project (as shown in Figure 13)

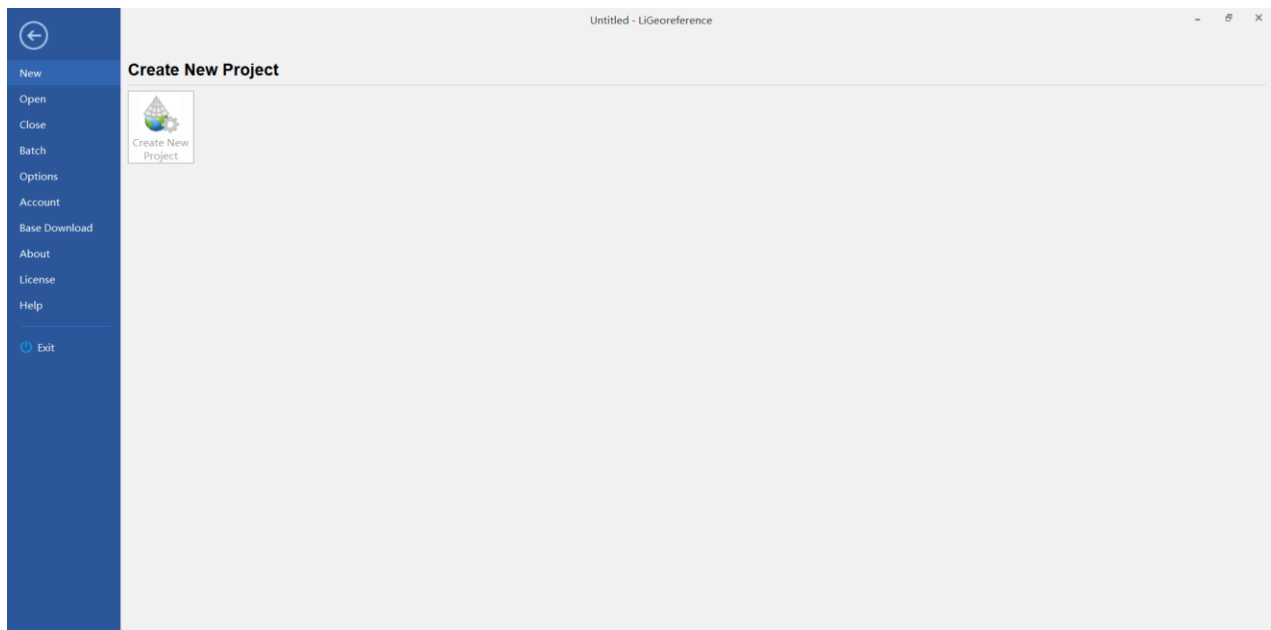

Figure 13. Open Project Interface

- After opening the project, the georeferencing tool will automatically import the **IMU file** .



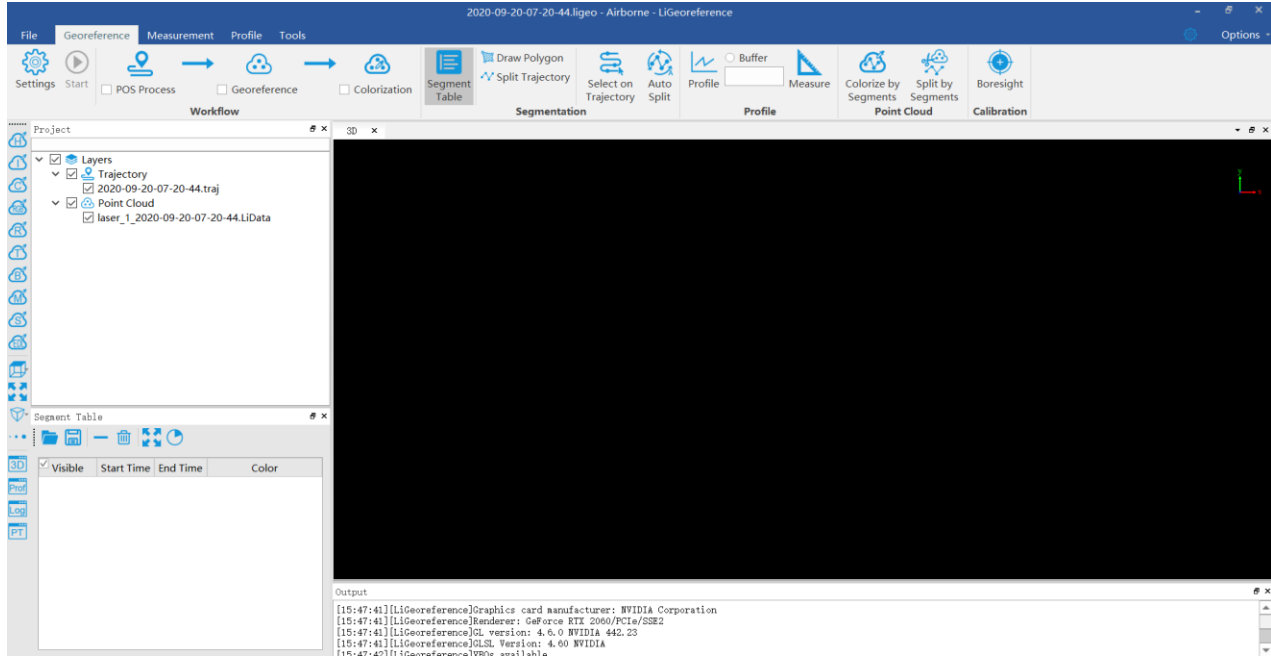

Figure 14. Trajectory Display

## 5.2.2 Select and Configure Parameters

Before undertaking post-processing procedure, users can use the "Settings" function to set the calculation parameters, including laser settings, camera settings, pos process and target coordinate system settings. Normally, users only need to set pos process settings and target coordinate system settings.

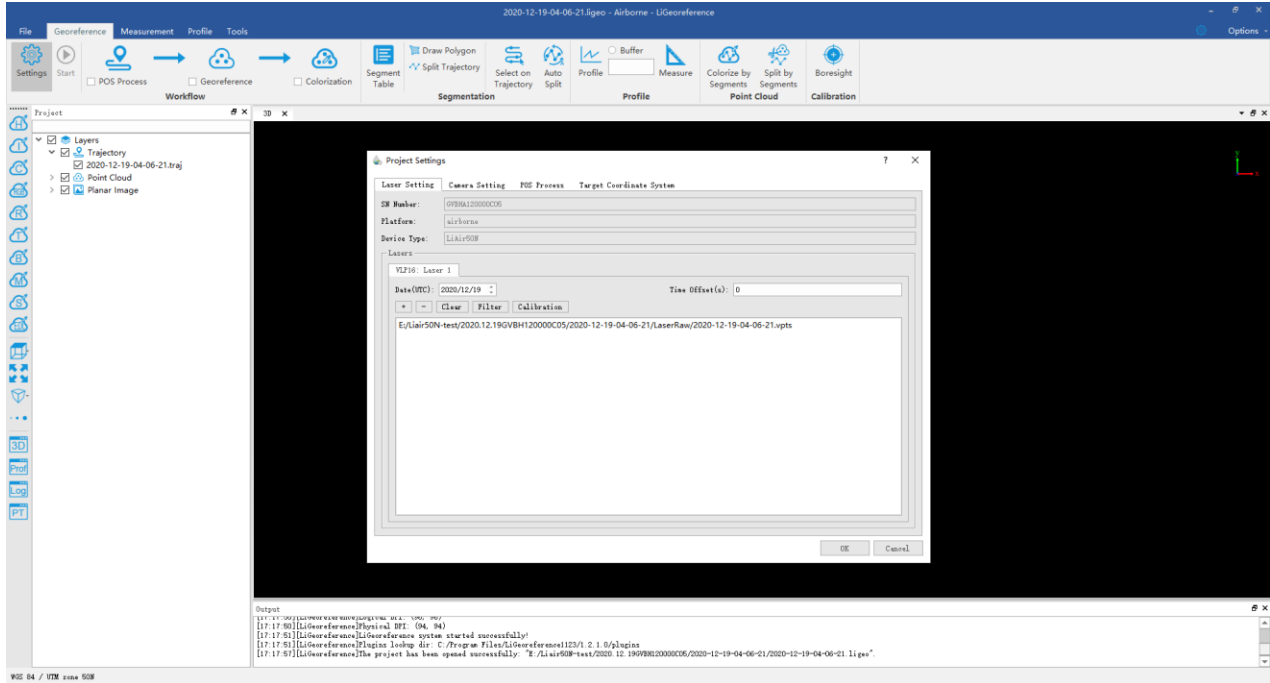

Figure 15. Set Icon

- **Pos Processing Settings**

LiGeo software has pos calculation and point cloud calculation functions. Users could directly use LiGeo software to calculate LiAir 220N's trajectory, or choose to use other third-party software to perform pos processing procedure.

- **Using LiGeo to Perform Pos Processing Procedure**

Select the "Pos Processing" button in the setting interface.

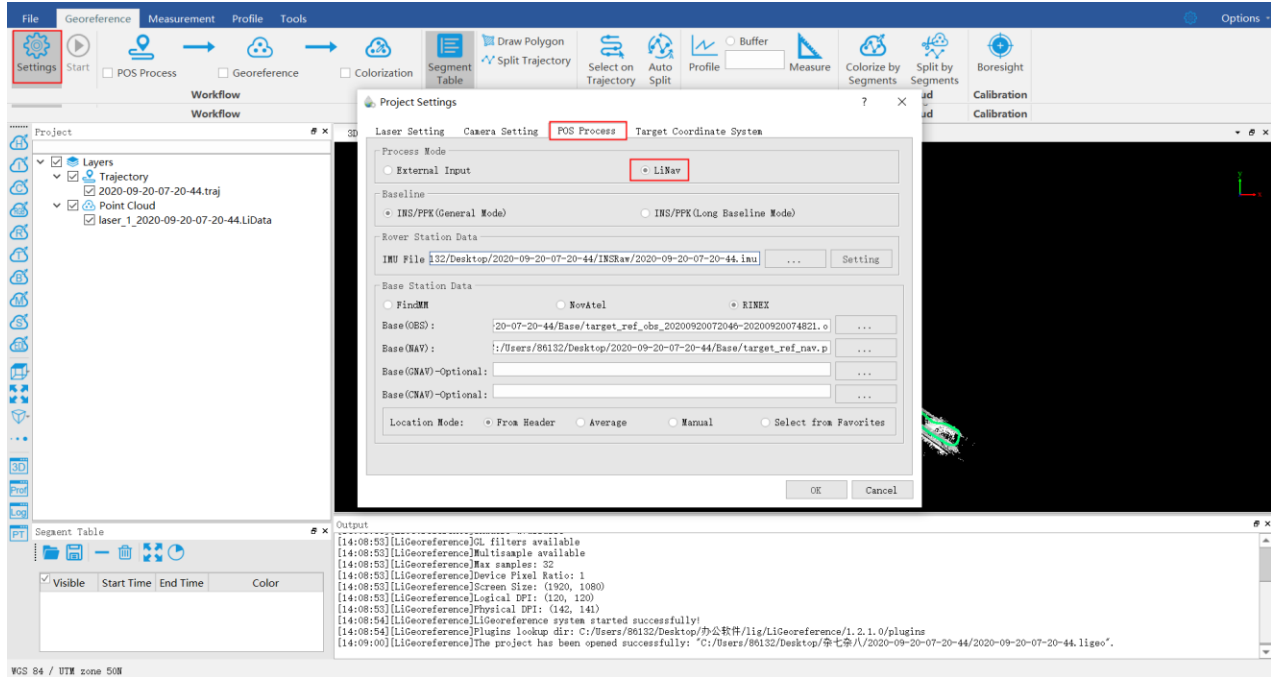

Figure 16. Pos Setting Interface

(1) Select LiNav processing mode

(2) Select the processing mode according to the length of the trajectory. It is recommended to use the general mode. When the length of the trajectory is more than 10 km, the long baseline mode can be selected.

(3) Load rover station data, under normal circumstances, the software will automatically read the rover station data under the project folder

(4) Select base station data

Under normal circumstances, the software will automatically read the base station data in the project folder, or manually load the base station data.

If the format of the local base station is the Rinex format, select the Rinex option to load the base station data.

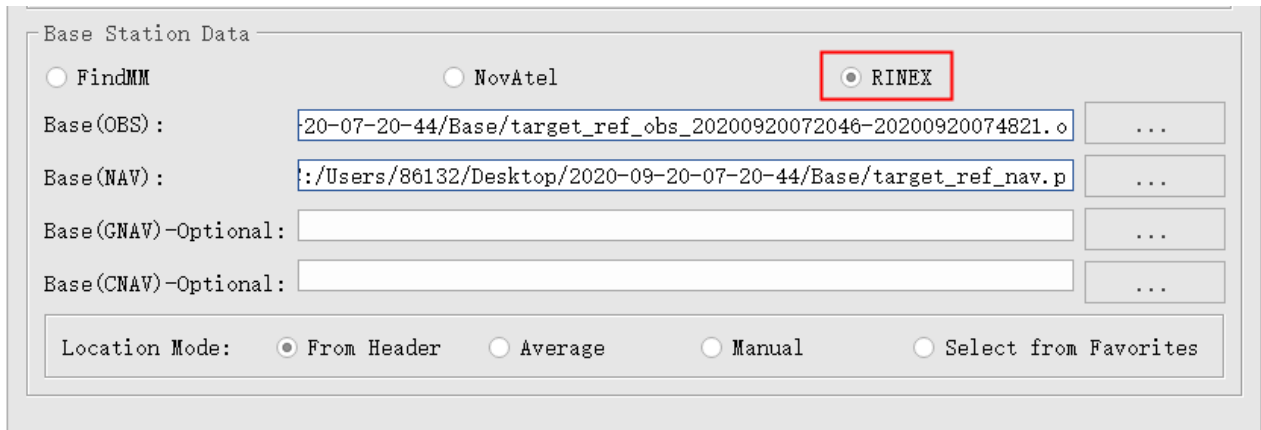

**Figure 17. "Rinex" Display Interface**

If the local base station format is Log format, select the Novatel option.

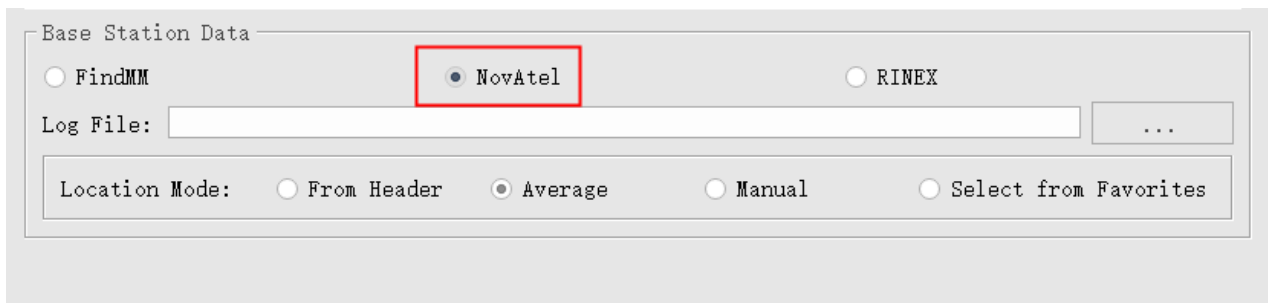

**Figure 18. "Novatel" Display Interface**

(5) Enter the Base Station Coordinates

- When there is no precise base station coordinate, users could select "Average" mode. And the positioning principle is single point positioning, which leads to meter-level errors between the point cloud coordinates calculated by this method and the true coordinates.
- When there are accurate base station coordinates, users could manually input the base station coordinates. Additionally, users could use "Save to Favorites" function to save the entered base station coordinates, and later can directly use the saved base station coordinates through "Select from Favorites".

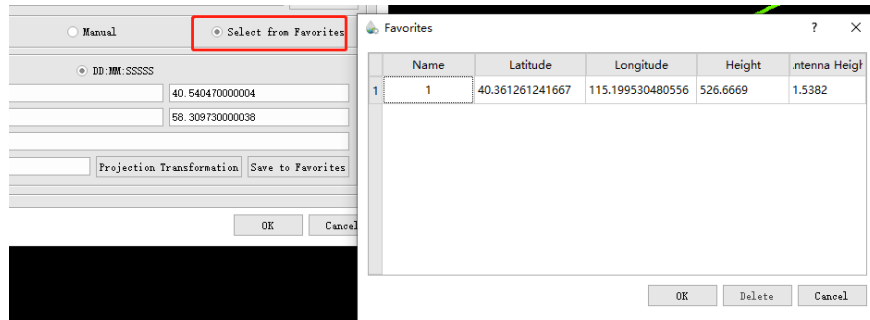

Figure 19. “Select from Favorites” Display Interface

- Analyze from the data header: some base station files and base station coordinates are stored in the header file. “From Header” option needs to be clicked when users want to use this function. For example, Cloud Trajectory base station is normally stored in this mode.

- Select from favorites: Users could select the base station coordinates stored in the software.

- Import External IMU or Existing Pos Data

Select "External Input" under Process Mode to import .pos data.

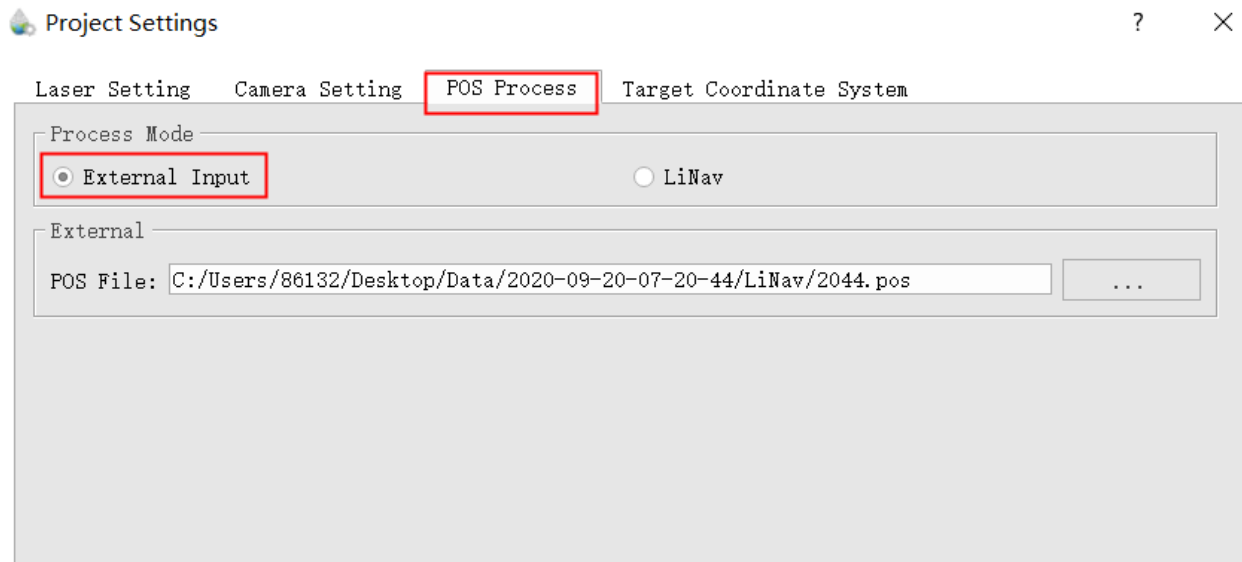

Figure 20. “External Input” Display Interface

The external input function supports importing the original IMU data and the processed POS data, and the specific format includes \*.pos, \*.out, \*.pof, \*.sbtc, \*.imu.

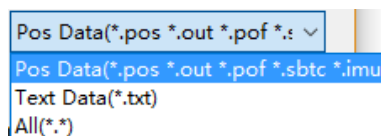

Figure 21. “Multiple Data Format” Display Interface

• **Laser Setting**

Normally, the user does not need to change the parameters of the laser setting interface. If users want to limit the output power range by reflectivity, distance and scanning angle, users could change the range via clicking “Filter” to set the parameters. For more details, please visit LiGeoreference users guide.

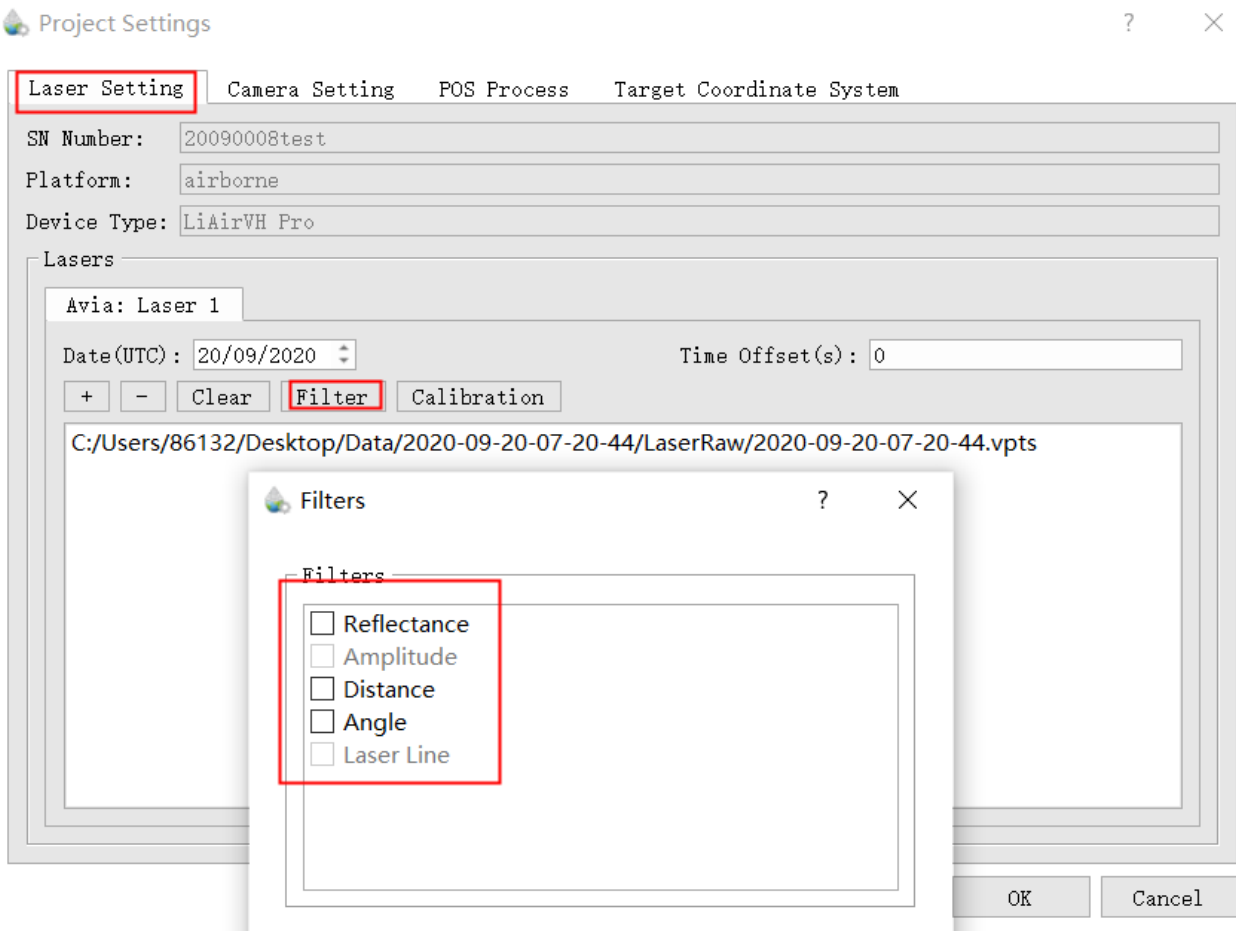

Figure 22. “Laser Setting” Display Interface

• **Camera Setting**

Normally, users do not need to change the parameters of the camera setting interface.

Uniform Color Function: sometimes the shooting is affected by the light and the uniform color function will make the light and dark more uniform, but will blur the color slightly.

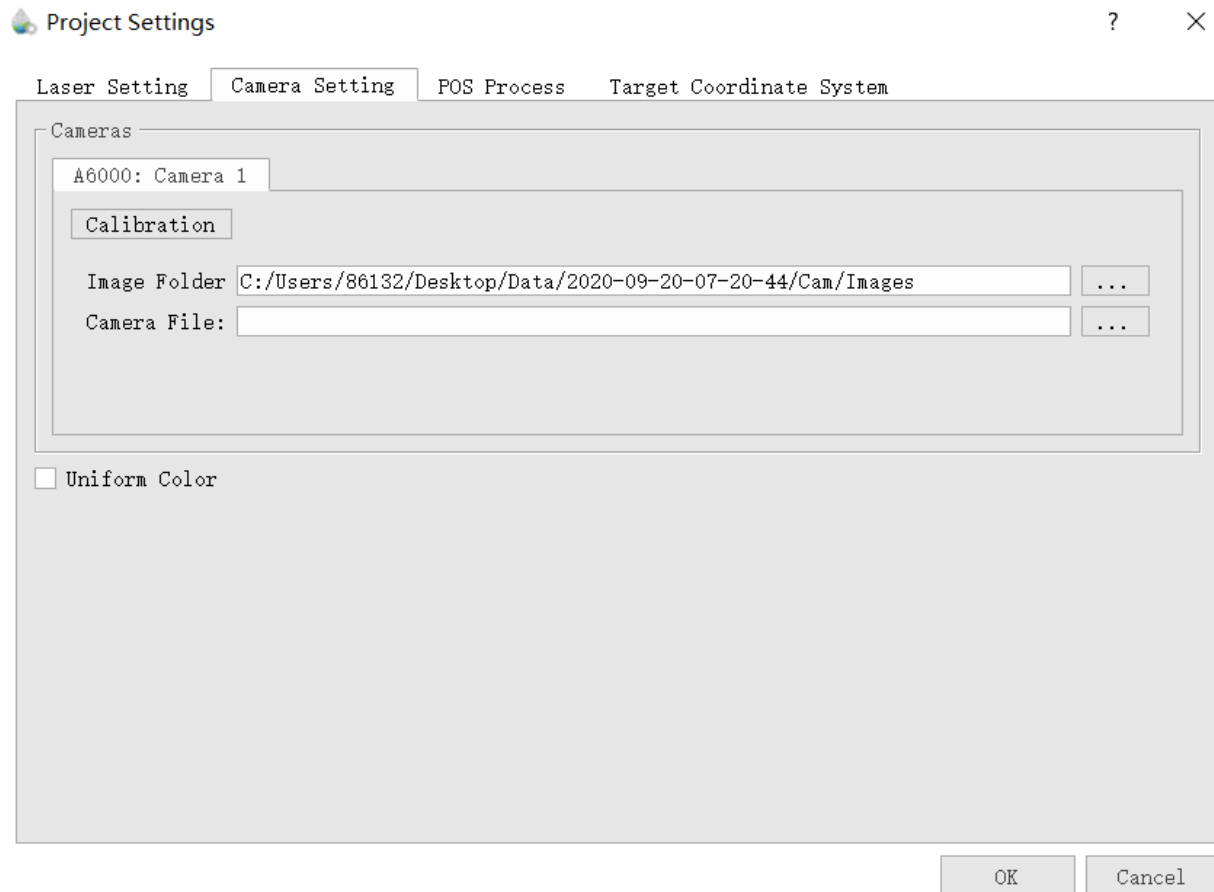

Figure 23. “Camera Setting” Display Interface

## 5.2.3 Georeferencing Point Cloud Data

### 5.2.3.1 Select Georeference Range

Users could select the range to be georeferenced as needed. And there are two modes to be selected, including "trajectory selection" or "draw polygon". And this document only introduces the operation process of using the "trajectory selection" tool. The way of "drawing polygon" could be found in the user manual of LiGeoreference software.

- (1) Click the "Select On Trajectory" button on the main interface of the software, and a table will automatically pop up at the same time, select the trajectory which needs to be georeferenced, and click OK.

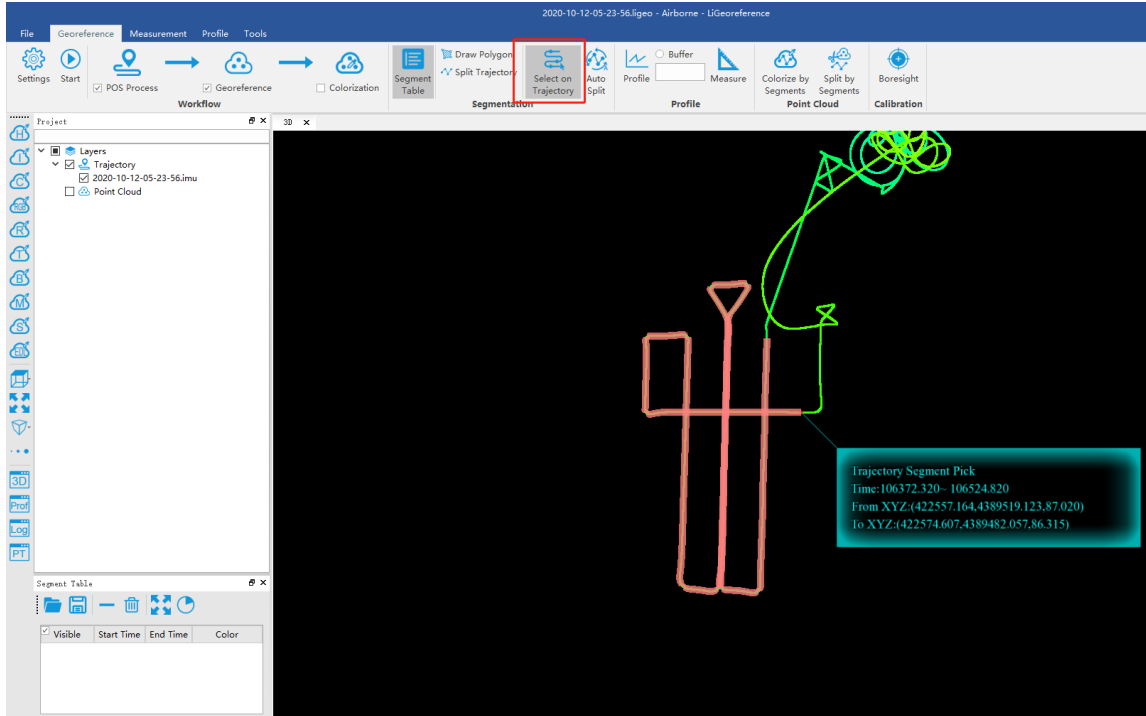

Figure 24. “Select On Trajectory” Display Interface

- (2) If needed to select multiple trajectories, then repeat the above operation, and the selected trajectory segments will be displayed in the cutting table at the lower left corner.

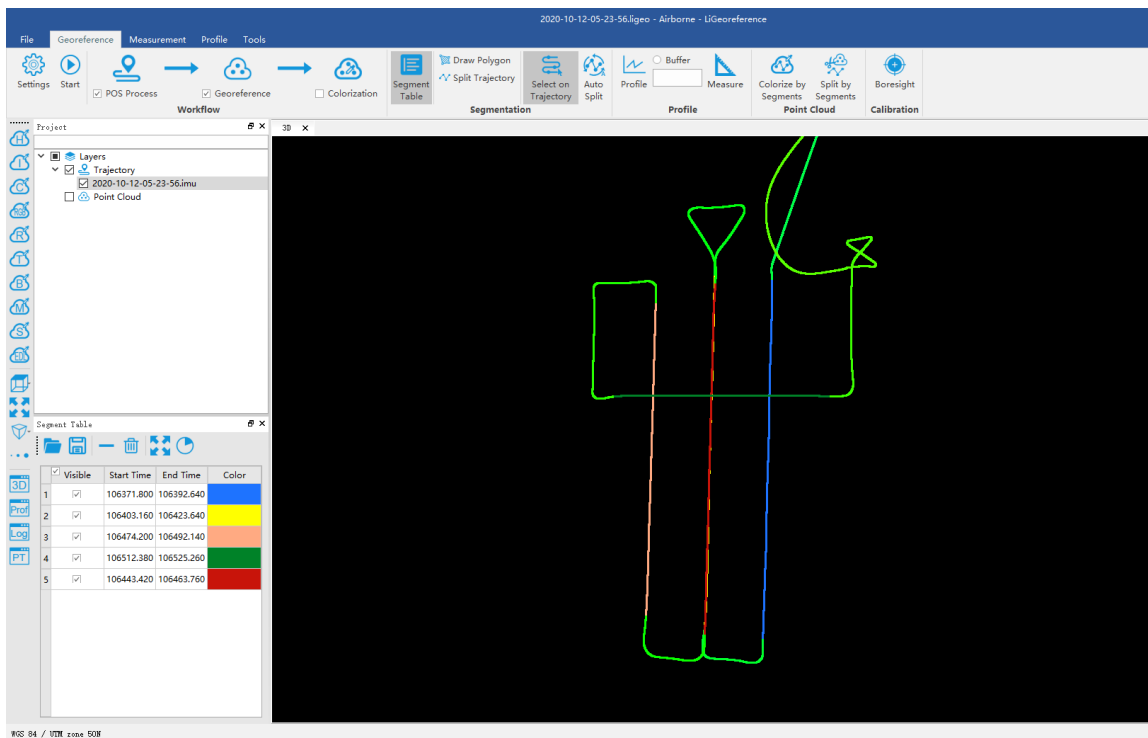

Figure 25. “Select On Trajectory” Display Interface



### 5.2.3.2 Select Processing Module

After opening the project, LiGeo will select “POS Process” and “Georeference” module by default. Users could check and rechoose the function modules as needed.

Note: If there is no image data, please do not choose "Colorization" module, otherwise the program will prompt an error.

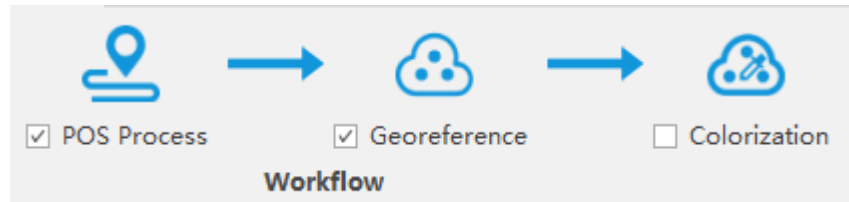

Figure 26. “Processing Module” Display Interface

### 5.2.3.3 Data Georeferencing

Click "Start" button to start data calculation. After the calculation is completed, the point cloud is automatically displayed in the main window.

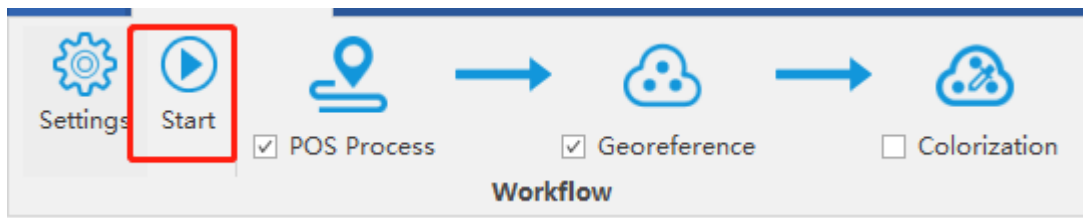

Figure 27. “Start” Display Interface

### 5.2.4 Data Quality Assessment

If the user needs to view the “Trajectory Report” and the “Image Overlap Report”, click the "Trajectory Plot" (or "Trajectory Report") or “Image Overlap Report” (only suitable for devices with cameras) under the "Tools" bar.

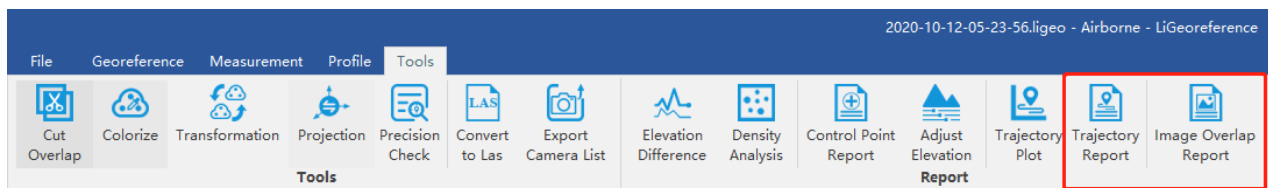

Figure 28. “Report” Display Interface

#### 5.2.4.1 Trajectory Report

Accuracy Assessment of Integrated Navigation System (INS) Report

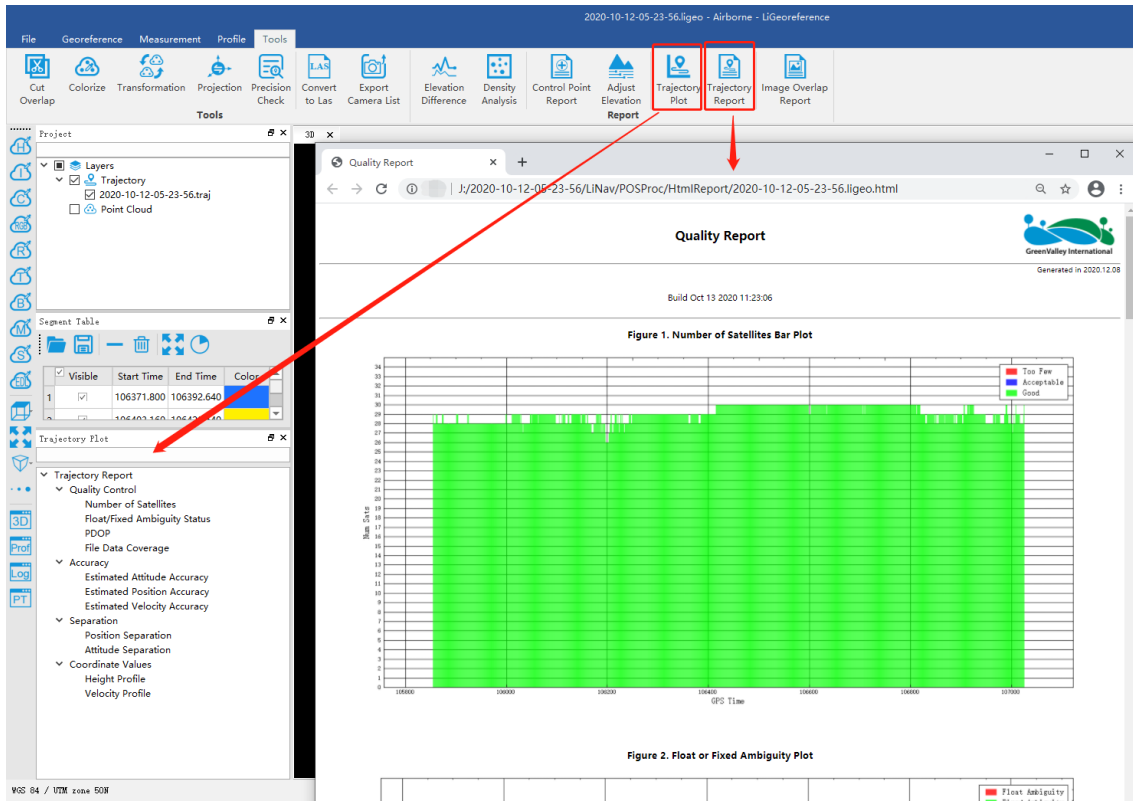

Figure 29. "Report" Display Interface

- Satellites Number:** Click to open the plot to show the relation between number of satellites, which can be reached, and the GPS time. This tool is used to show the number of satellites can be reached by the device each time during the data acquisition. Satellites number is shown on the Y-axis. The green part on the plot means the number of satellites is good at that time. The blue part on the plot means the number of satellites is just acceptable at that time. While the red part means the satellite number is too few to meet the requirement. The insufficient GNSS signal will result in poor data quality. If the number of satellites can be reached by the device is too few during a period of data acquisition, user can select the time period and right-click on that. Then click "Go to Time" button to find out the corresponding period on the trajectory.

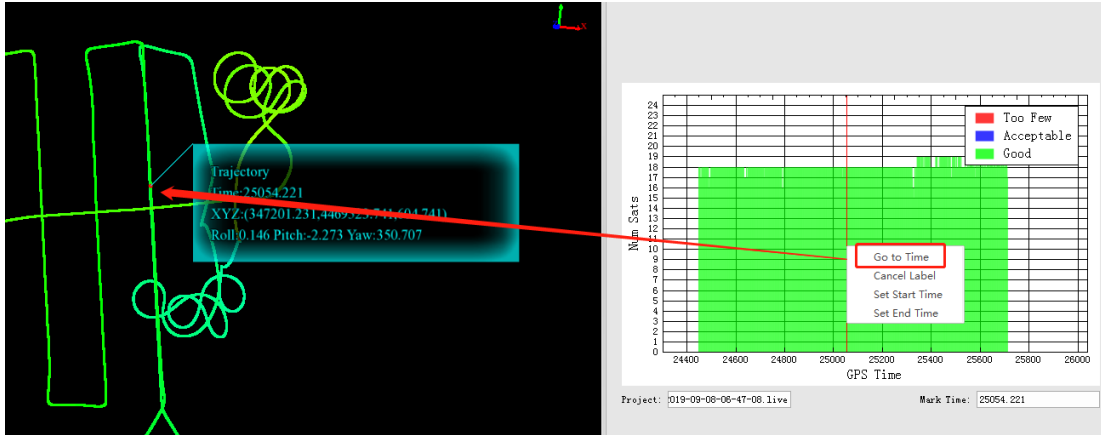

Figure 30-1 Trajectory Report - Satellite Numbers

- **Floating/Fixed ambiguity status:** Click to show the plot of ambiguity resolution status. This is used to show the situation of cycle ambiguity resolution. If the status is shown as green on the plot, it means the cycle ambiguity resolution is fixed. If it is red on the plot, it means the cycle ambiguity resolution is floating.

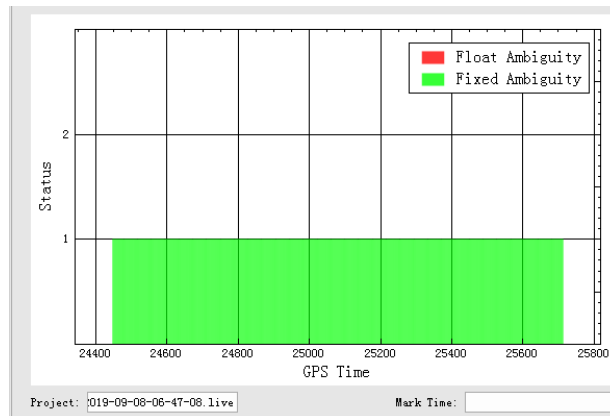
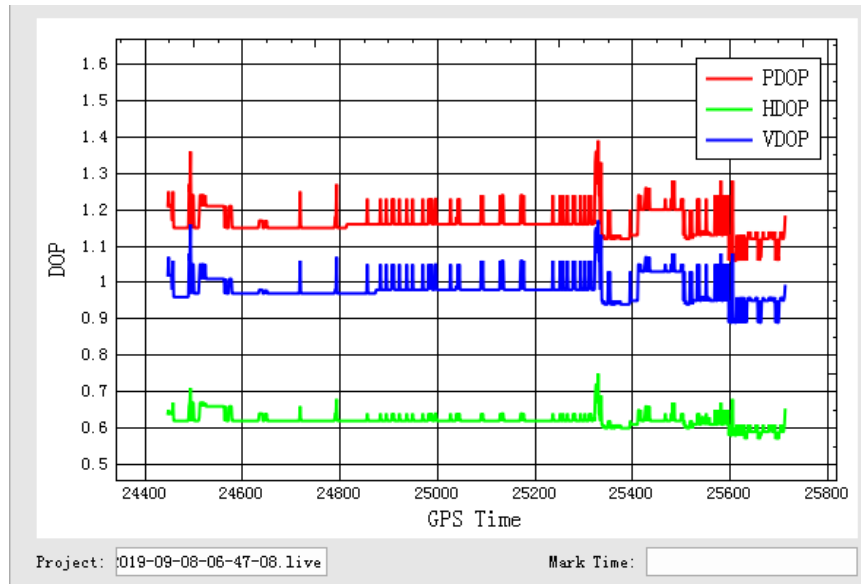

Figure 30-2 Trajectory Report - Floating/Fixed Ambiguity Status

- **PDOP:** Position dilution of precision, or PDOP, shows the distribution of the GNSS satellites. Click to show the plot of PDOP. The smaller PDOP is, the better the distribution is.



**Figure 30-3 Trajectory Report - PDOP**

- b. **File Data Coverage:** Click to show the plot of data coverage situation. This is used to show the data coverage relation among base station data, IMU data, and GNSS data of the moving device.

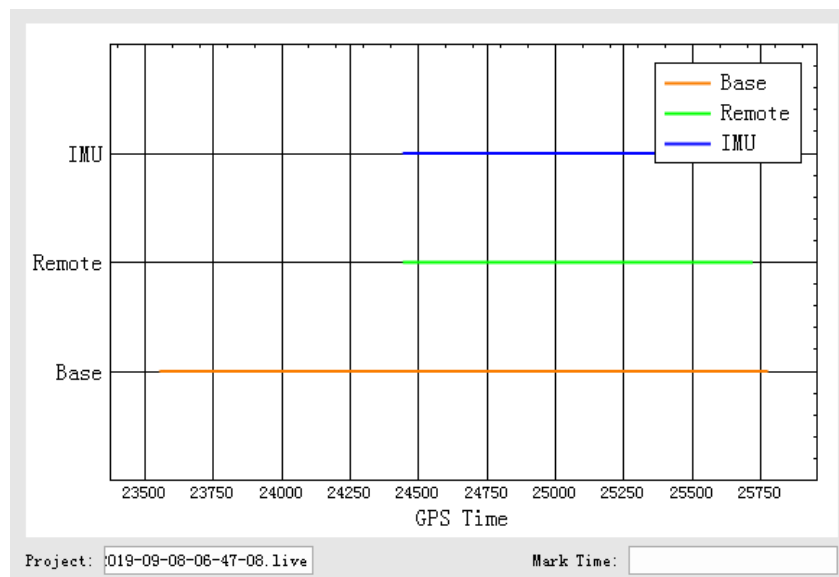

**Figure 30-4 Trajectory Report - File Data Coverage**

- c. **Estimated Attitude Accuracy:** Click to show the plot of attitude accuracy. This plot is used to show that if the accuracy exceeds the limitation of the IMU accuracy. The X-axis shows the GPS time. The Y-axis shows the attitude accuracy. Red line is for changes in Roll direction. Green line

shows the changes in Pitch direction. While the blue line shows the changes in the heading direction.

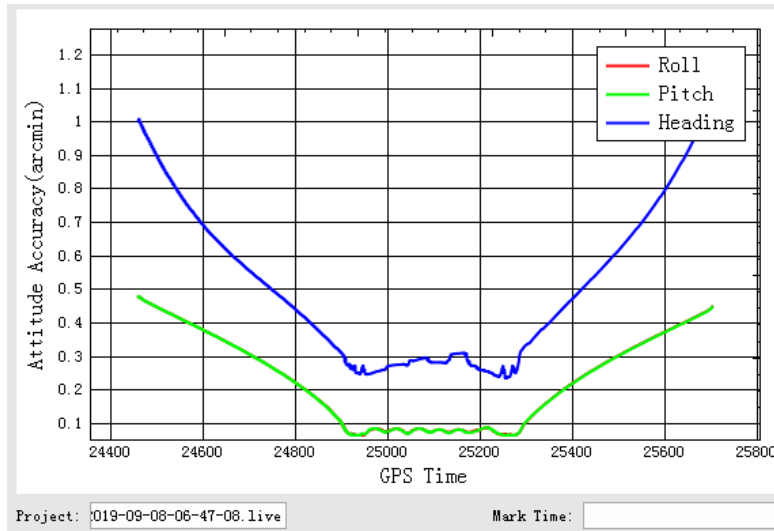

Figure 30-5 Trajectory Report - Estimated Attitude Accuracy

- d. **Estimated Position Accuracy:** Click to plot the position accuracy. The X-axis shows the GPS time. The Yaxis shows the position accuracy. Red line is for position accuracy in East direction. Green line shows the position accuracy in North direction. While the blue line shows the position accuracy in height direction.

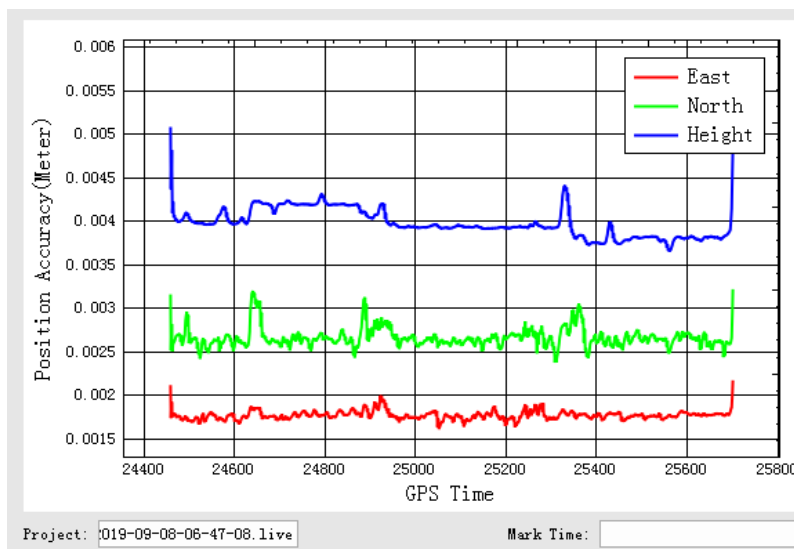

Figure 30-6 Trajectory Report - Estimated Position Accuracy

- e. **Estimated Velocity Accuracy:** Click to plot the velocity accuracy. The X-axis shows the GPS time. The Yaxis shows the velocity accuracy. Red line is for velocity accuracy in East direction. Green line shows the velocity accuracy in North direction. While the blue line shows the position velocity in height direction.

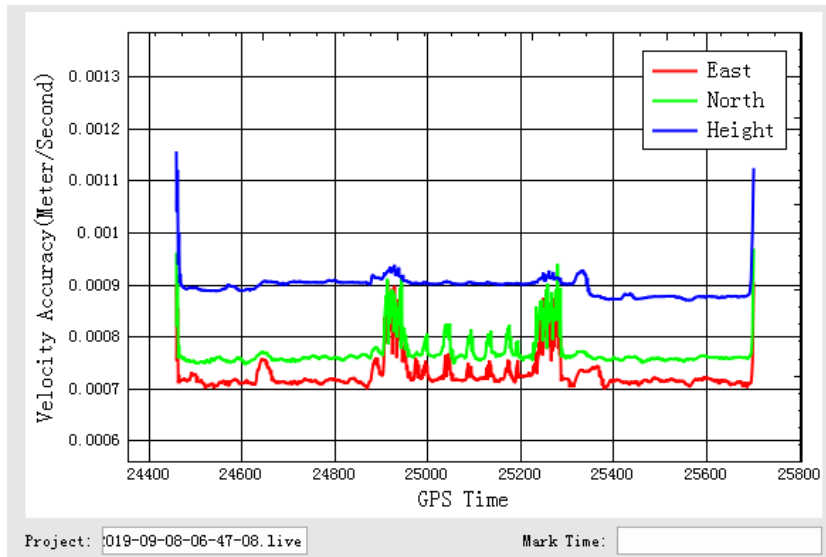

Figure 30-7 Trajectory Report - Estimated Velocity Accuracy

- f. **Position Separation:** Click to plot the position separation. This plot shows the differences of position in East, North, and Up directions during the forward-backward processing.

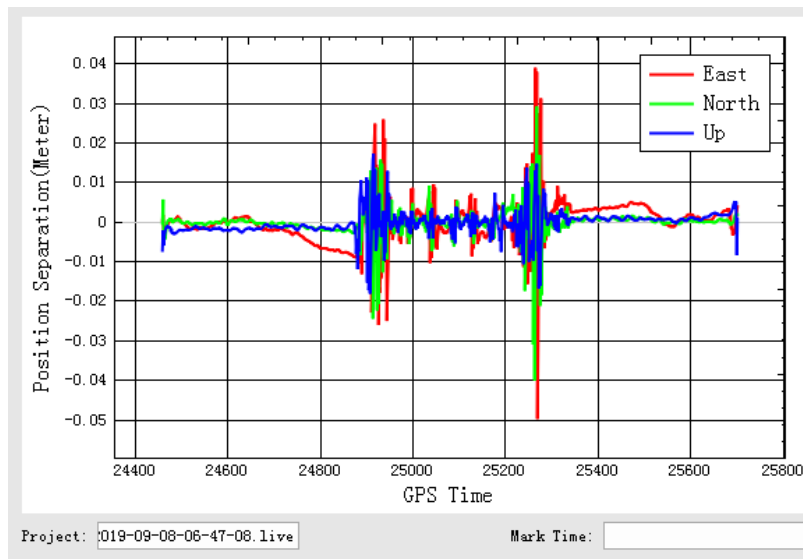

Figure 30-8 Trajectory Report - Position Separation

- g. **Attitude Separation:** Click to show the plot of attitude separation. This plot is used to show the difference among the angles in Roll, Heading, and Pitch directions during the forward-backward processing. The smaller the value is, the better the matching degree of the forward-backward processing is.

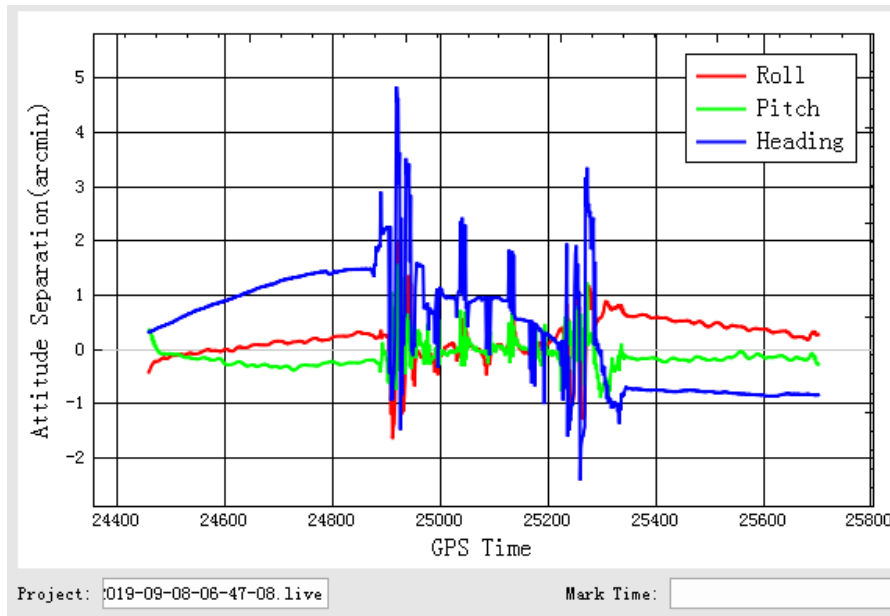

Figure 30-9 Trajectory Report - Attitude Separation

- h. **Height Profile:** This plot shows the changes in height during the data acquisition.

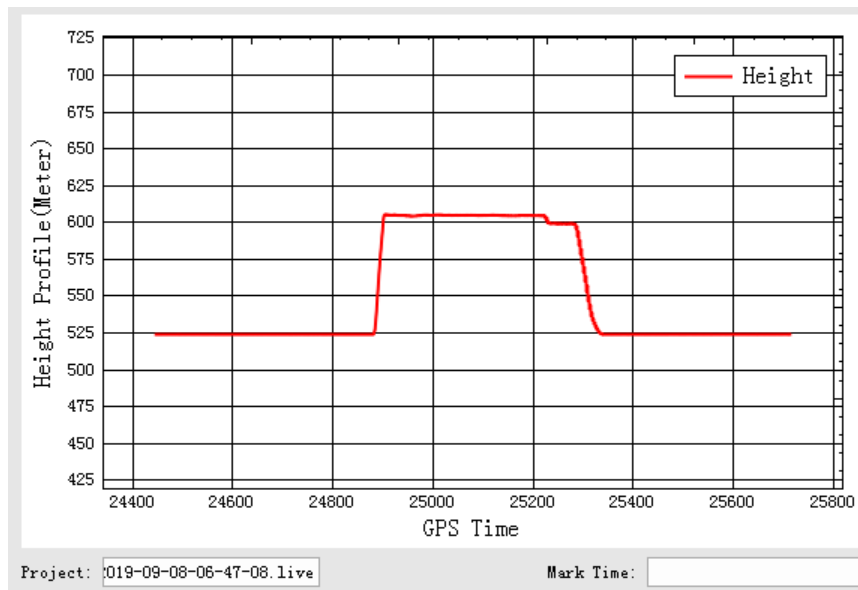

Figure 30-10 Trajectory Report - Height Profile

- i. **Velocity Profile:** This plot shows the changes in velocity during the data acquisition. Red line is for the changes in East direction. Green shows the changes in North direction. While the blue line shows the changes in up direction to the ground.

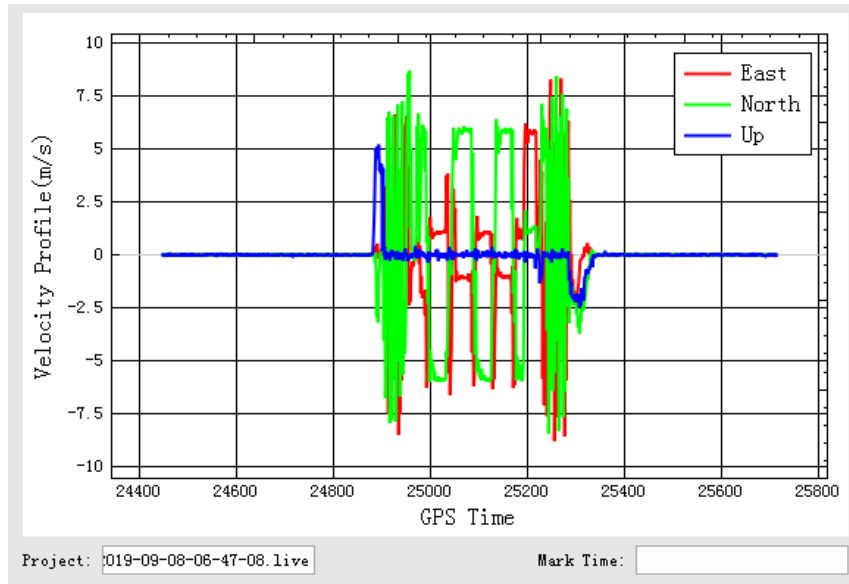

Figure 30-11 Trajectory Report - Velocity Profile

### 5.2.4.2 Image Overlap Report

The image overlap report lists the image overlap. The report could check whether the photos are lost.



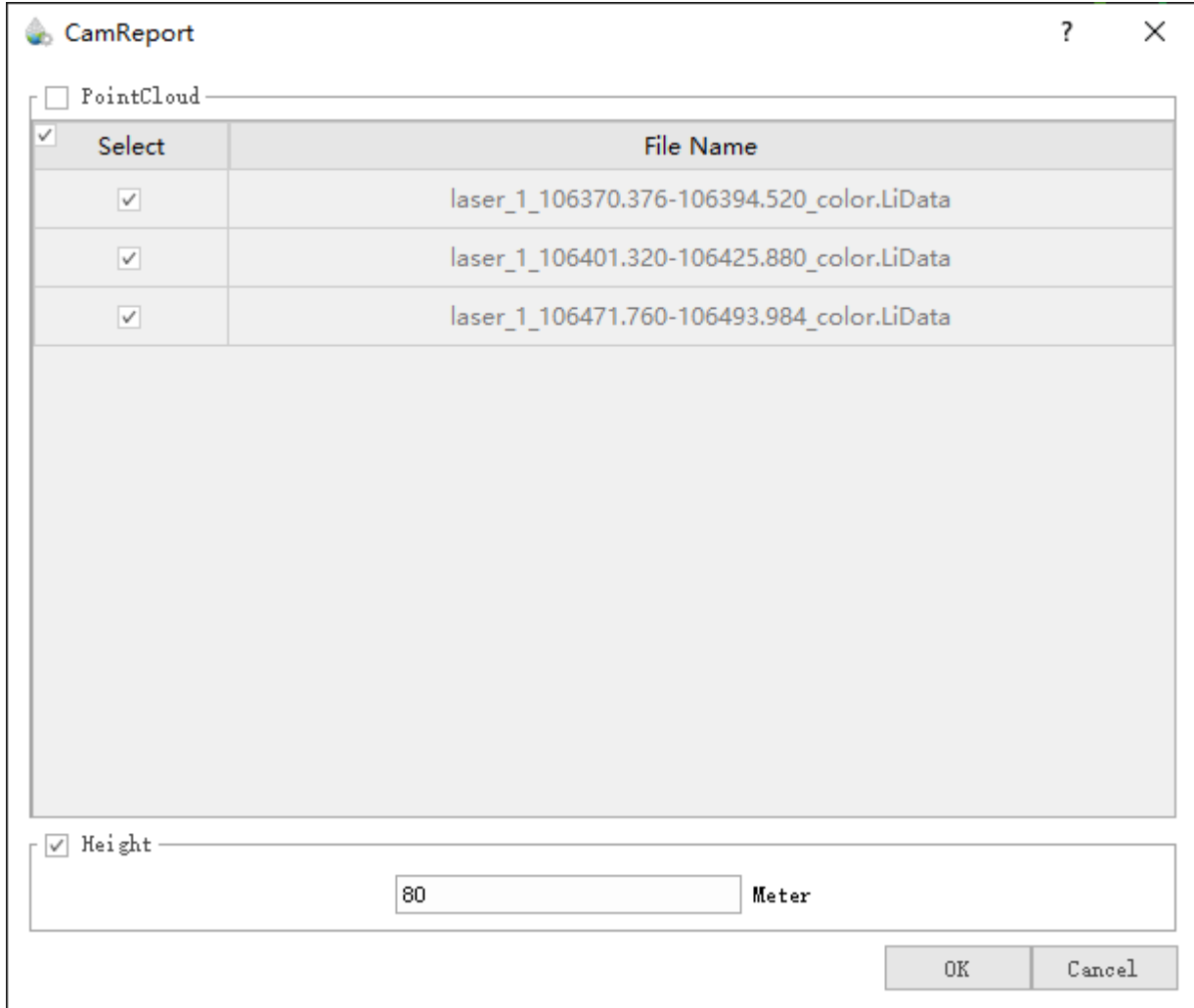

Figure 31. "Image Overlap Report" Display Interface

## 6.Special Notes

Here are some special Note to pay attention while operating LiAir 220N. GVI has compiled these Note based on experiences and feedback from customers. The following points out details that seem small or insignificant but can, however, lead to issues that may be difficult or impossible to rectify post mission if left unchecked.

### Operation Notice & Equipment Maintenance

- The LiAir 220N system integrates several high-precision instruments. Please handle with care.
- Avoid direct impact to the system. Always store all items properly in the protective case before transporting. Do not move or transport the system unprotected.
- This product should be stored and transported in the protective case provided by or authorized for use by GVI.
- Do NOT scratch the **Laser Scanner Lens**.
- Ensure the **Laser Scanner Lens** surface is clean before mission. Only clean the lens with special cleaning agents for high-precision measurement instruments and optics with soft cloth.
- Clean the product thoroughly after each use. Use only proper cleaning agents for scientific instrument.
- Pull the power off softly and properly disconnect all batteries, antennas, and cables after use.
- Please perform power-on test if the machine is not used for more than one month.
- Do NOT operate the system in raining or harsh environment outside its safe temperature range.
- System safe operating temperature: 0°C to + 40°C.
- Storage temperature: -10°C to + 60°C.
- This product is NOT water-proof. Do NOT operate in rain or snow. Water damage is NOT covered by the Product Warranty. When not in use, store the product in a cool and dry environment.

- Tampering with the product is strictly prohibited and will void the Product Warranty. Any repair, modification, or upgrade must be performed by GVI technician or authorized service provider.
- This product is a high-precision mapping and surveying instrument that must be handled with care. Damages caused by improper handling of the product are not covered by your warranty.